

To buy, sell, rent or trade-in this product please click on the link below:
<https://www.avionteq.com/Konica-Minolta-LS-150-Luminance-Meter>

AvionTEq
□ □ □ □ □ □ □ □ □ □
www.avionteq.com

CHROMA METER CS-150 / CS-160 LUMINANCE METER LS-150 / LS-160

Instruction Manual



Please read this manual
before using the instrument.



KONICA MINOLTA

Safety Symbols

The following symbols are used in this manual to prevent accidents which may occur as a result of incorrect use of the instrument.



Denotes a sentence regarding a safety warning or note.
Read the sentence carefully to ensure safe and correct use.



Denotes a prohibited operation.
The operation must never be performed.



Denotes an instruction.
The instruction must be strictly adhered to.



Denotes an instruction.
The AC adapter must be disconnected from the AC outlet.



Denotes a prohibited operation.
Never disassemble the instrument.



This symbol indicates AC (alternating current).















This symbol indicates DC (direct current).

Notes on this Manual

- Copying or reproduction of all or part of the contents of this manual without the permission of KONICA MINOLTA is strictly prohibited.
- The contents of this manual are subject to change without prior notice.
- Every effort has been made in the preparation of this manual to ensure the accuracy of its contents. However, should you have any questions or find any errors, please contact a KONICA MINOLTA-authorized service facility.
- KONICA MINOLTA will not accept any responsibility for the consequences arising from the use of the instrument.

Safety Precautions

To ensure correct use of this instrument, read the following instructions carefully and adhere to them. After you have read this manual, keep it in a safe place where it can be referred to any time a question arises.

	WARNING (Failure to adhere to the following instructions may result in death or serious injury.)
	Do not use the instrument in places where flammable or combustible gases (gasoline etc.) are present. Doing so may cause a fire.
	For the AC adapter, only use the optional AC adapter specified by KONICA MINOLTA (AC-A305J/L/M) and connect it to an indoor AC outlet of the rated voltage and frequency (100-240 VAC \sim 50/60 Hz). If other AC adapters or different voltage is used, it may result in damage to the instrument or AC adapter or a fire or an electric shock.
	If the instrument will not be used for a long time, disconnect the AC adapter from the AC outlet. Accumulated dirt or water on the prongs of the AC adapter's plug may cause a fire and should be removed.
	Insert the power plug of the AC adapter securely and completely into the outlet. If the power plug is not inserted completely, it may cause a fire or an electric shock.
	Do not bend the USB cable by force, or twist or pull it. Do not put a heavy object on the cable and do not damage or modify it. A damaged cable may cause a fire or an electric shock.
	Do not modify or disassemble the instrument or the AC adapter. Doing so may cause a fire or an electric shock.
	Take special care not to allow liquid or metal objects to enter the instrument. Doing so may cause a fire or an electric shock. Should any liquid or metal objects enter the instrument, turn the power OFF immediately, disconnect the AC adapter from the AC outlet and/or remove the batteries, and contact the nearest KONICA MINOLTA-authorized service facility.
	Do not put the batteries into a fire and do not recharge, short-circuit, heat, or disassemble them. Doing so may cause the batteries to explode or leak, leading to a fire or an electric shock.
	If leaked battery fluid gets in a person's eyes, wash the eyes with clean water without rubbing and then seek medical attention immediately. If leaked fluid comes in contact with hands or clothes, rinse it off thoroughly with water. Do not continue the use of a leaking battery.
	When discarding the batteries used in the instrument, isolate the terminals with tape or other material. If the terminal comes in contact with a metal object, it may cause heat, an explosion, or a fire. Make sure that the batteries are either disposed of or recycled correctly in accordance with local laws and regulations.
	Do not continue the use of the instrument and/or AC adapter if they are damaged or if they produce smoke or odd smells. Doing so may cause a fire. In such situations, turn the power OFF immediately, disconnect the AC adapter from the AC outlet and/or remove the batteries, and contact the nearest KONICA MINOLTA-authorized service facility.



Never try to look at the sun or strong light through the viewfinder of the instrument. This may cause vision loss.



Do not insert or disconnect the AC adapter with wet hands. Doing so may cause an electric shock.



Do not touch or hold the batteries with wet hands. Doing so may cause an electric shock or a breakdown.



CAUTION

(Failure to adhere to the following instructions may result in injury or physical damage.)



When using the AC adapter, provide an environment such that there is an outlet near the instrument and the power plug of the AC adapter can be easily plugged or unplugged.



When cleaning the instrument, unplug the power plug of the AC adapter from the outlet. Not doing so may cause an electric shock.



Do not use any batteries other than those specified for the instrument. Do not use a new battery and an old battery or batteries of different types together. When loading the batteries into the instrument, ensure they are oriented according to the polarity indication (positive + and negative -) on the instrument. Otherwise, the batteries may break or leak, resulting in a fire or injury, or contamination of the area.



Do not use wet batteries. Do not use the instrument while water remains in the battery compartment. This may cause the batteries to explode or produce heat, leading to a fire or injury.



Do not place the instrument on a wobbly stand or an inclined surface. The instrument may drop or fall, leading to injury. When carrying the instrument, be careful not to drop it.



Do not move while looking through the viewfinder. Doing so may cause you to fall over or other accidents.



Take extreme caution when handling the close-up lens. Otherwise, the lens may break, leading to injury.



Nickel-metal-hydride batteries must be charged with a dedicated charger. Charging the batteries under conditions or with chargers other than those specified may cause fluid leak, heat, or a fire.

Introduction

This instrument is a Chroma Meter/Luminance Meter that can measure luminance/ chromaticity with accuracy comparable to spectroradiometers, through the adoption of a newly developed filter. Read this manual carefully before use.

Packing materials of the product

Be sure to keep all packing materials used for shipping the product (cardboard box, cushioning material, plastic bags, etc.).

This instrument is a precision measuring instrument. When transporting the instrument to a service facility for maintenance or for other reasons, be sure to use these packing materials to minimize shock or vibration.

If the packing materials are lost or damaged, contact a KONICA MINOLTA-authorized service facility.

Notes on Use

Operating Environment

- The AC adapter (AC-A305J/L/M) provided as an optional accessory of the instrument is designed for indoor use only. Do not use it outdoors.
- This instrument consists of precision electronic components and must not be disassembled.
- For the AC adapter, use the one provided as an optional accessory (AC-A305J/L/M) and connect it to an AC outlet of the rated voltage and frequency (100-240 VAC ~ 50/60 Hz). Use an AC power supply of the rated supply voltage (within $\pm 10\%$).
- This instrument is classified as a pollution level 2 product (equipment mainly used in manufacturing sites, laboratories, warehouses, or other equivalent locations). Use it in an environment with no metallic dust and no possibility of condensation.
- This instrument belongs to installation category II (equipment which is powered through the connection to commercially available power supply).
- Be careful not to allow foreign matter to enter the instrument. It poses an extreme danger to use the instrument with water or metal objects inside.
- Do not use the instrument in direct sunlight or near a heating appliance. The internal temperature of the instrument may become much higher than the ambient temperature, leading to breakdown.
- Do not use the instrument in areas with rapid temperature change to avoid condensation.
- Avoid the use of the instrument in areas with extreme dust or humidity.
- The instrument should be installed and used at a temperature between 0°C and 40°C and a relative humidity of 85% or less (at 35°C) with no condensation. Any use outside of this range may not satisfy the expected performance.
- Do not use the instrument at altitudes higher than 2,000 m.

Handling the Instrument

- Do not subject the instrument to strong impact or vibration.
- Do not pull the supplied USB cable, bend it by force, or apply a strong force to it. Otherwise, wire breakage may result.
- Connect a power supply with minimal noise.
- If you notice any possibility of breakdown or abnormality, turn the power OFF immediately, disconnect the AC adapter from the AC outlet and refer to the "Checking for Malfunction" page 105 section.
- In case of breakdown, do not disassemble the instrument by yourself, instead contact the nearest KONICA MINOLTA-authorized service facility.

Backup Battery

- This instrument saves various settings in the memory backed up with an internal backup battery. The backup battery is charged continuously when the instrument is connected to the power supply, regardless of whether the power switch is set to ON or OFF. It is fully charged in about 20 hours and there is no danger of overcharging. Data can be retained for one year with a fully charged battery. Immediately after the purchase, however, the battery charge may be low on purchase so it may be necessary to charge the battery while using the instrument.
- Do not try to replace the internal backup battery yourself. For replacement, contact a KONICA MINOLTA-authorized service facility.
- It is recommended to save a backup of your important data by using the data management software CS-S20.

Objective Lens and Close-up Lens (Optional Accessory)

- Before measurement, ensure that the surfaces of the objective lens and close-up lens (if applicable) are clean. Any dust, stain, or soil remaining on the lens surface may prevent proper measurement.
- Do not touch the surface of the objective/close-up lens with your fingers.
- Note that sudden temperature changes in a highly humid environment may cause the objective/close-up lens to mist over, preventing proper measurement.

Recommended Battery Type

- When the surrounding temperature is low, the performance of the batteries themselves is degraded and the number of measurements decreases. To prevent this problem, when using the instrument at low temperatures, it is recommended to use batteries that are less affected by temperature changes, such as nickel-metal-hydride batteries, for the power supply.
- Nickel-metal-hydride batteries must be charged with a dedicated charger. Charging the batteries under the conditions or with chargers other than those specified may cause fluid leak, heat, or a fire.

Notes on Storage

Instrument

- Do not store the instrument in direct sunlight or near a heating appliance. The internal temperature of the instrument may become much higher than the ambient temperature, leading to breakdown.
- The instrument should be stored at a temperature between 0°C and 45°C and a relative humidity of 85% or less (at 35°C) with no condensation. When stored at a high temperature/humidity, the instrument may not satisfy the expected performance. We recommend that the instrument is stored at a room temperature with a drying agent.
- Avoid condensation during storage. Also, pay attention to sudden temperature changes during transportation to the storage place to avoid condensation.
- Use the packing materials used for shipment or the hard case supplied as standard (CS-A12) and store the instrument in a safe location.
- Be careful not to get your hand trapped in the opening of the hard case. This may cause injury.

Objective Lens

- Store the objective lens with the lens cap (standard accessory) attached.

Notes on Cleaning

Instrument

- When the instrument is dirty, wipe off dirt with a soft clean dry cloth. Do not use organic solvents (benzene or thinner) or other chemicals for cleaning. If you are unable to remove dirt from the instrument, contact a KONICA MINOLTA-authorized service facility.

Objective Lens

- When the lens is dirty or dust accumulates on it, wipe off dirt with a soft clean dry cloth or lens cleaning paper. Do not use organic solvents (benzene or thinner) or other chemicals for cleaning. If the dirt cannot be removed contact a KONICA MINOLTA-authorized service facility.

Notes on Transportation

- Use the packing materials used for shipment to transport the instrument. This protects the instrument from vibration and shock.
- To return the instrument to a KONICA MINOLTA-authorized service facility, return it together with all accessories in the same package.

Maintenance and Inspection

- To maintain the measurement accuracy of the instrument, periodic inspection, about once a year, is recommended. For details of the inspection, contact a KONICA MINOLTA-authorized service facility.

Disposal Method

- Make sure that the instrument, its accessories (including used batteries), and the packing materials are either disposed of or recycled correctly in accordance with local laws and regulations.

Table of Contents

Safety Precautions	1
Introduction	3
Notes on Use	3
Operating Environment	3
Handling the Instrument	4
Backup Battery	4
Objective Lens and Close-up Lens (Optional Accessory)	4
Recommended Battery Type	4
Notes on Storage	5
Instrument	5
Objective Lens.....	5
Notes on Cleaning	5
Instrument	5
Objective Lens.....	5
Notes on Transportation	5
Maintenance and Inspection	5
Disposal Method	5
Standard Accessories	8
Optional Accessories	9
System Configuration Diagram	10
Names and Functions of Parts	11
Part Names	11
Major Functions of Parts	12
Key Panel	13
Major Functions of Keys	13
Viewfinder Display	14
CS/LS-150	14
CS/LS-160	14
Visibility Adjustment	14
LCD Screen	15
Layout.....	15
Measurement Screen	16
Various Messages	17
1. First Startup	17
2. Daily Operation.....	17
3. Error	18

Preparation

Installing Batteries	20
Notes on Use	20
Battery Level Indicator	21
Installing Batteries	21
Connecting the AC Adapter	22
Connection Procedure	23
Turning Power ON ()/OFF (○)	24
Setting the Power Switch to ON	24
Setting the Power Switch to OFF	24
Wrist Strap	25
Attaching the Wrist Strap.....	25
Holding the Instrument	25
Caution During Carrying.....	25
Mounting	26

Settings

Selecting the Integration Time	28
Setting the Synchronized Measurement Mode	30
Selecting the Maximum/ Minimum Value	32
Setting the Selectable Color Spaces ..	34
Selecting the Color Space	36
Selecting the Decimal Places for the Chromaticity Display	38
Selecting the Color Correction Factor (C.C.F.)	40
Selecting the Close-up Lens	42
Selecting the Measuring Button Function	44
Setting the Measurement Result Saving	46

Setting the Display Brightness	48
Turning the Backlight ON/OFF	49
Setting the Auto Power Off	50
Setting the Periodic Calibration Alert Display	52
Setting a Luminance Unit	54
Initializing the Settings	56
Setting the Internal Clock	58
Selecting the Display Language	60
Checking the Instrument Information	62

Measurement Preparation

Calibration	64
Calibration Channels	64
User Calibration	65
Performing User Calibration	66
1. By Measurement	66
2. By Selecting Stored Data	68
Calibration Value Input Rule	70
Setting/Changing the Target	71
Target	71
1. By Measurement and Registration ..	72
2. By Selecting Stored Data	74
3. By Entering Values	76

Measurement

Selecting and Checking the Target/ Calibration Channel	80
Measurement	82
Selecting the Absolute Value/ Difference/Ratio Display	84
Checking the Measurement Result ...	86

Deleting Stored Data	88
Deleting All Stored Data	90

Communication

Connection to a PC	94
Remote Mode	95

Explanation and Information

Light-Receiving Element (Sensor)	98
L _v T _{cp} duv Color Space	99
Dominant Wavelength/ Excitation Purity	100
Object Color Measurement	101
Dimensions	102
Error Messages	103
Checking for Malfunction	105
Specifications	108
MEMO	110

Standard Accessories

Lens cap

- When the instrument is not in use, attach this cap to protect the lens.

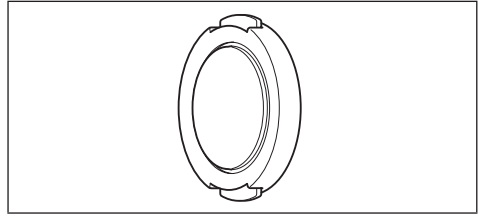

Eyepiece cap

- When the instrument is used in a fixed position, the presence of a bright light source on the viewfinder side may affect operation. In such cases, attach the supplied eyepiece cap on the eyepiece frame of the viewfinder.

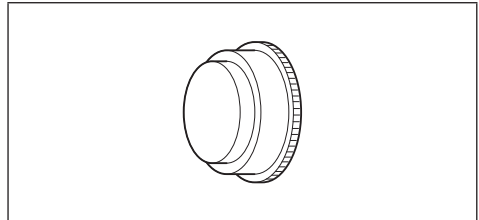

Wrist strap CS-A13

- Prevents accidental dropping of the instrument.

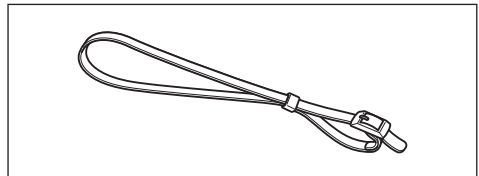

Eyepiece ND filter

- Reduces glare when you look into the viewfinder to measure bright objects. Always attach this filter on the viewfinder when you measure bright objects.

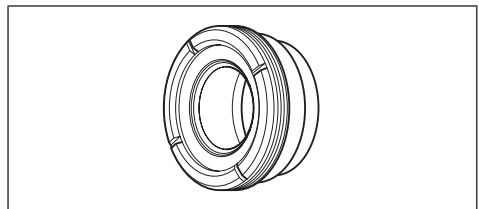

Hard case CS-A12

- Used to contain the instrument together with its accessories for storage or hand-carrying. This case must not be used for freight transportation.

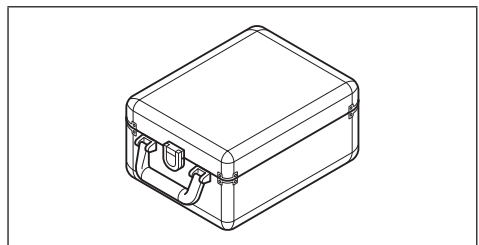

Data management software CS-S20

- Software that allows you to operate the instrument from a personal computer (PC) and perform data management.

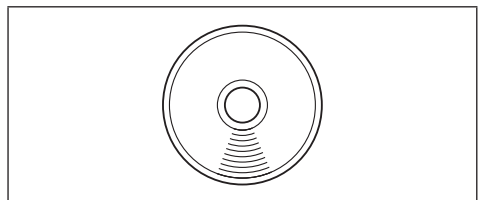

USB cable (2 m) T-A15

- Used to connect the instrument to a PC. This cable is also used for supplying power with the AC adapter.

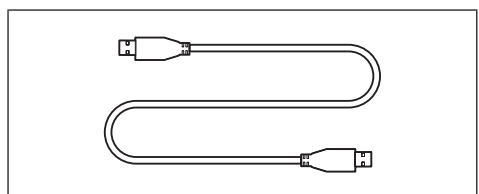

Optional Accessories

Close-up lens

No. 153, No. 135, No. 122, No. 110

- Attach the close-up lens in front of the objective lens to measure extremely small objects.

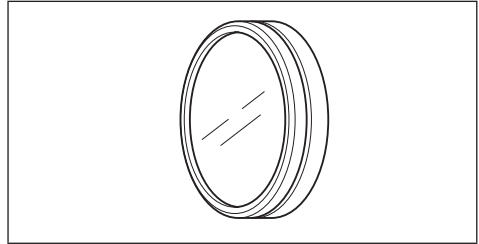

CCD camera adapter CS-A14

- When using a C-mount industrial camera, mount it onto the viewfinder by placing this adapter in-between.

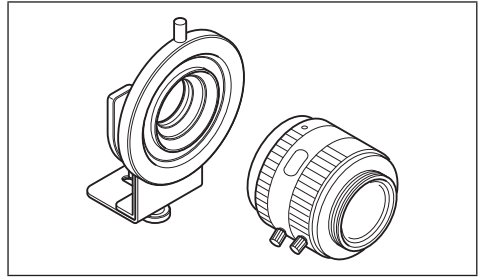

White calibration plate (for 45-0) CS-A20

- Used for object color measurement.

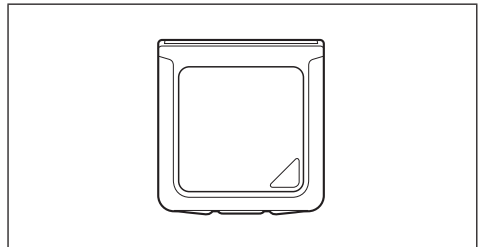

AC adapter AC-A305J/L/M (UBX305)

- Used to supply power from an AC outlet to the instrument.
Input: 100-240 V \sim 50/60 Hz 0.15 A
Output: 5 V DC 1 A

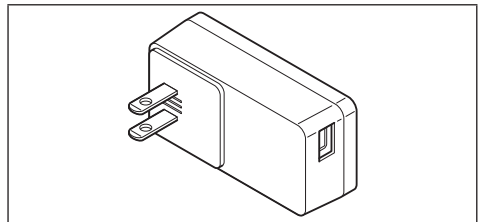

Illuminance adapter CS-A15

- Attach this adapter in front of the lens to measure illuminance of incident light.

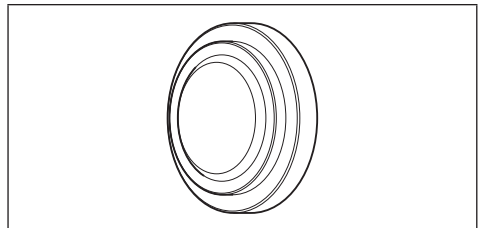

System Configuration Diagram

———— Standard accessories

----- Optional accessories

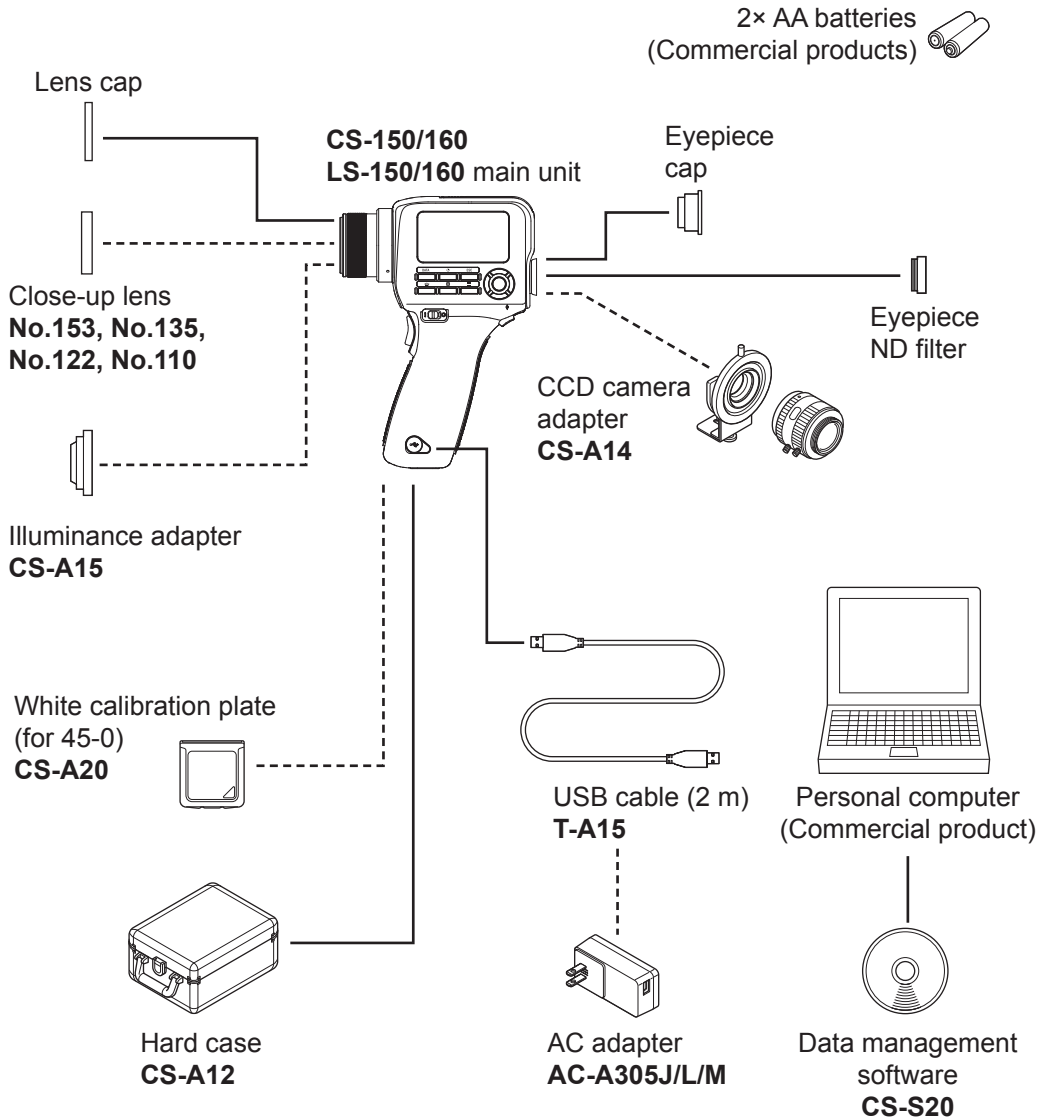

Names and Functions of Parts

Part Names

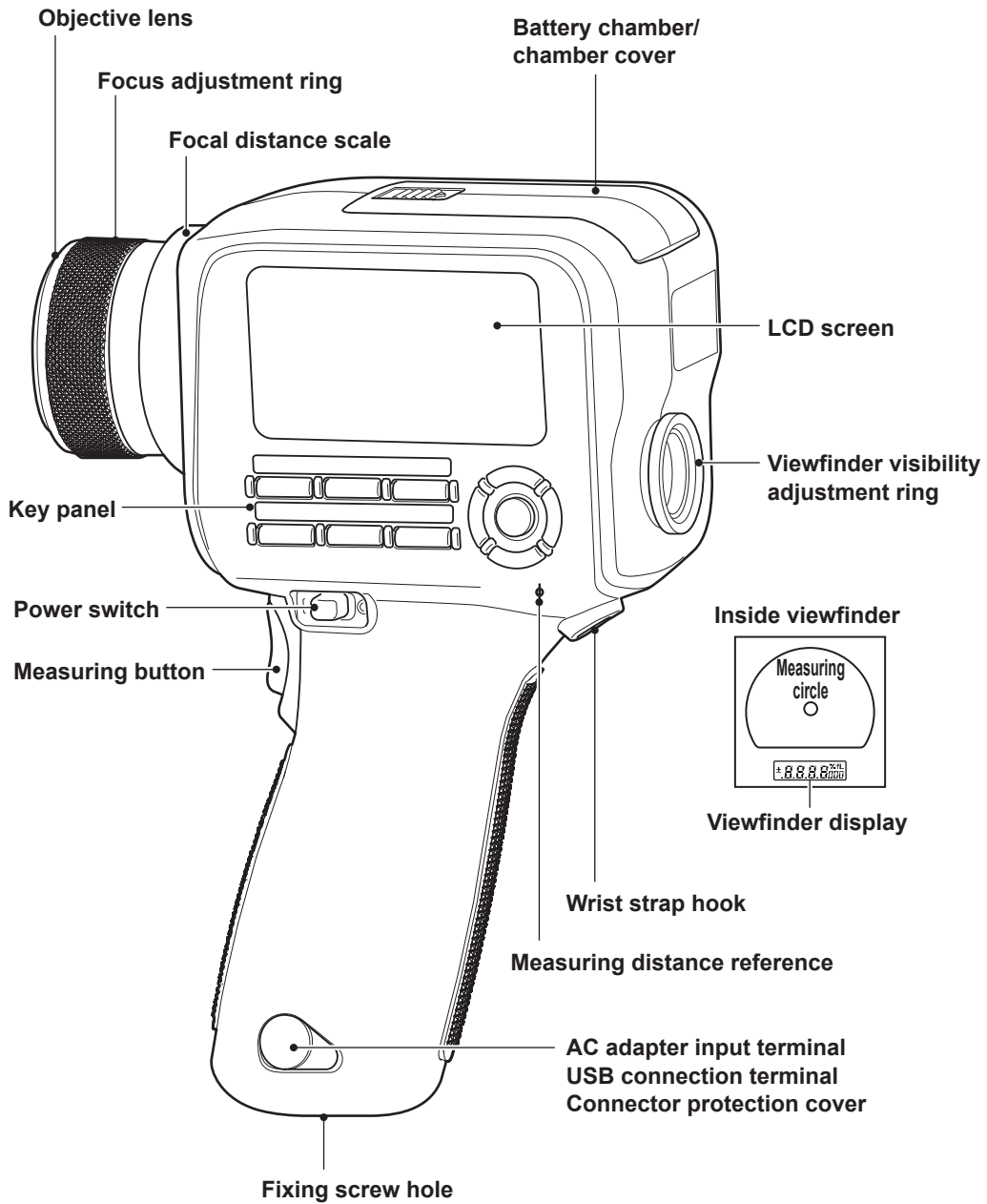

Major Functions of Parts

Power switch	Used to turn the instrument ON (side) or OFF (○ side). (page 24)
AC adapter input terminal	Used to connect the optional AC adapter. (page 22)
USB connection terminal	Used to connect the USB cable to connect the instrument to a PC..... (page 94)
Objective lens	This part is directed at the object to be measured to perform measurement.
Connector protection cover	Protects the AC adapter input terminal and USB connection terminal..... (page 23, 94)
Measuring distance reference (page 11, 26, 82)
Focus adjustment ring	Used to adjust the focus of the objective lens during measurement..... (page 82)
Focal distance scale	A scale showing the reference focus position..... (page 82)
LCD screen	Displays various screens such as the measurement screen and menu screen..... (page 15)
Key panel	Contains keys used for operating the instrument. ... (page 13)
Measuring button	Pressing this button performs measurement, and releasing it holds the value. (Standard mode) (page 82)
Viewfinder	An object is observed through this part during measurement. (page 14, 82)
Visibility adjustment ring	Used to adjust the visibility. (page 14, 82)
Measuring circle	Indicates the measuring area. (page 14)
Viewfinder display	Shows an L_v value (absolute value, difference, or ratio). (page 14, 82)
Wrist strap hook	Used to attach the wrist strap when holding the instrument by hand..... (page 25)
Fixing screw hole	Used to mount the instrument onto a tripod or a jig. (page 26)
Battery chamber	Install the batteries here. (page 21)

Key Panel



Major Functions of Keys

1. **COLOR key**
(LS: **DATA** key) Press this key while the measurement screen is displayed to change the color space.
($L_v, x, y \rightarrow L_v, u', v' \rightarrow L_v, T_{cp}, duv \rightarrow X, Y, Z \rightarrow L_v, \lambda_d, P_e \rightarrow L_v, x, y$); With the LS, pressing this key displays the stored measurement result. (page 36)
2. **INFO key** Press this key to toggle the screen between the measurement screen and setting check screen (measurement condition, target, user calibration data).

Meas. Cond.	[Info] [Back] [Home]
Meas. Date/Time	2015/12/31
	12:34:56
Integ. Time	Auto
Sync. Meas.	OFF
Peak/Valley Meas.	OFF
3. **ESC key** While the menu, setting, or setting check screen is displayed, press this key to return to the measurement screen. During setting, press this key to return to the previous screen. During value input, press this key to cancel the setting.
4. **BACKLIGHT key** Press this key to turn the backlight of the LCD screen ON/OFF. (page 49)
5. **SAVE key** While the measurement screen is displayed, press this key to save the displayed measurement data into the memory.
6. **MENU key** Press this key to toggle the screen between the measurement screen and setting screen.
7. **UP/DOWN keys** Press these keys to move to the upper/lower items or to increase/decrease the setting value.
8. **LEFT/RIGHT keys** Press these keys to select the left/right tab or to move to the item on the left/right.
9. **ENTER key** Select a menu item and press this key to enter the setting screen for that item. During value input or setting, press this key to confirm the current setting.

Viewfinder Display

CS/LS-150

(Measuring angle 1°)

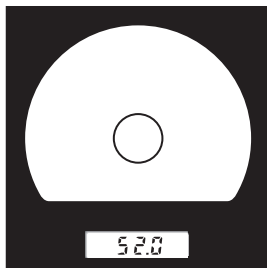

Viewfinder display
The L_v value is displayed.

CS/LS-160

(Measuring angle 0.3°)

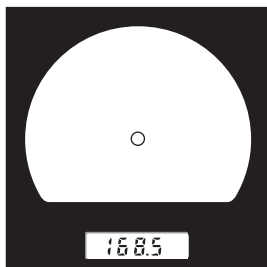

The L_v value is shown as an absolute value, difference (\pm), or ratio (%) according to the display setting.

$\pm .8.8.8.8000$ %fL

Visibility Adjustment

Turn the visibility adjustment ring on the viewfinder to adjust the visibility.

Observe the object to be measured through the viewfinder and adjust the ring so that the circle indicating the measuring area is seen sharply. The adjustment may be easier if done in the state where the object to be measured is out of focus (blurred image).

Be sure to adjust the visibility every time before you perform measurement. The visibility adjustment must be performed by the person who will perform measurement. If you adjust the focus without adjusting the visibility in advance, the focus cannot be adjusted properly as intended, resulting in incorrect measured values. Moreover, if the visibility is not adjusted properly, the position of the circle indicating the measuring area might vary depending on the viewing angle.

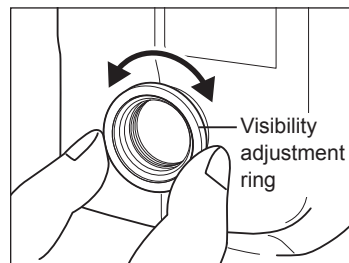

* Sometimes you may see small black spots or streaks in the viewfinder. These are caused by the characteristics of the optical system and not dust or dirt inside the viewfinder. They have no influence on the measurement performance.

LCD Screen Layout

Measurement screen

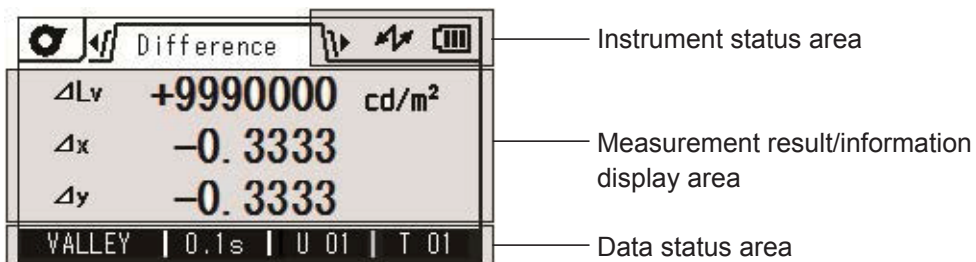

Setting screen

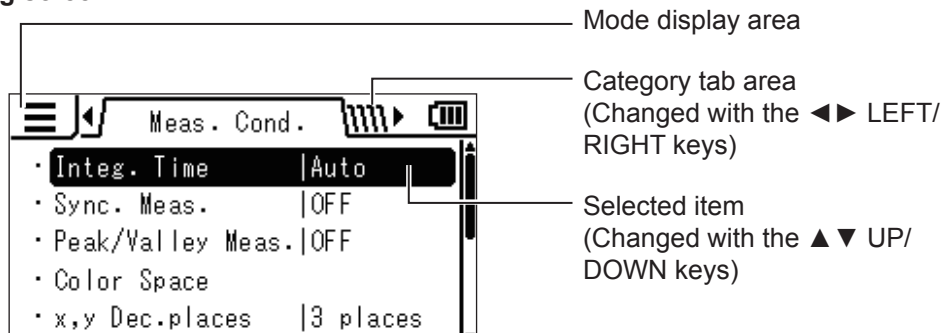

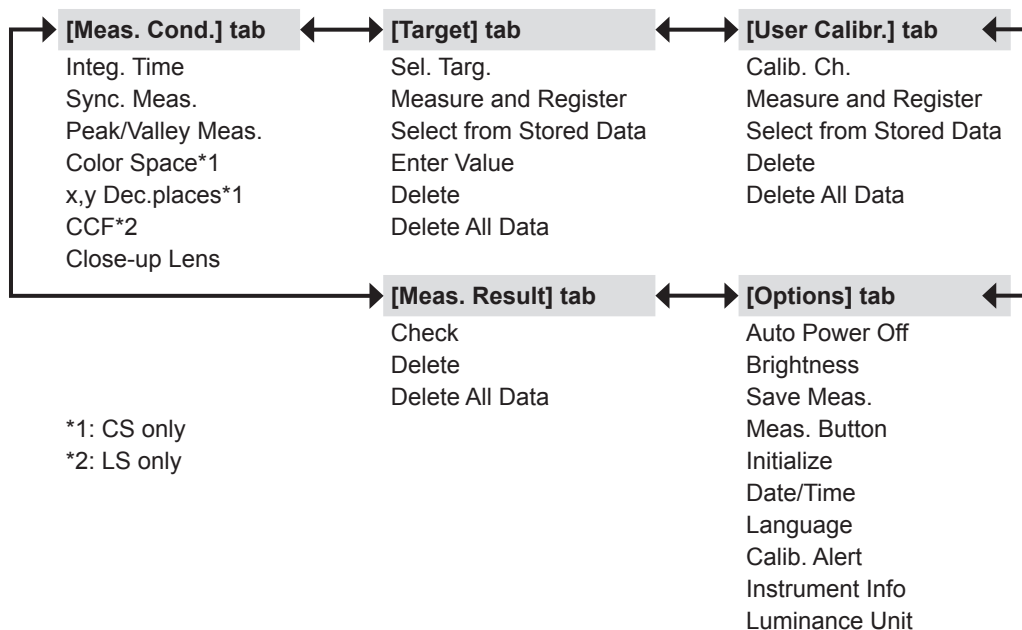

Menu structure of the instrument



LCD Screen

Measurement Screen

Status of the instrument

- : Measurement mode (Flashes during measurement)
- : Setting mode
- : Information mode

Type of measured value (absolute value, difference, or ratio)

USB connection symbol (page 94)

Measurement result. The result is shown with the currently selected color space. (L_vxy, L_uv', L_vT_{op} duv, XYZ, or dominant wavelength) (page 36)

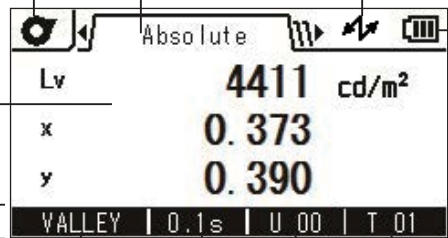

Battery level indicator (page 20)

Whether the measurement result was obtained at <PEAK> or <VALLEY> of the continuous measurement. (page 32)

Target number (page 80)

User calibration channel (page 80)

"REMOTE" is displayed when the instrument is controlled via remote connection.

Currently selected integration time mode (AUTO or Integ. Time) (page 28)

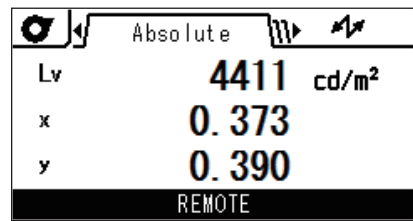

Various Messages

The LCD screen may display the following messages indicating the status of the instrument. Refer to the relevant description page when you see one of these messages.

1. First Startup

When the instrument is started for the first time, you need to select a display language and set the date and time. You will see screens that prompt you for these operations. Refer to the pages describing the procedures and complete the settings.

When a language has not been set
(page 60)

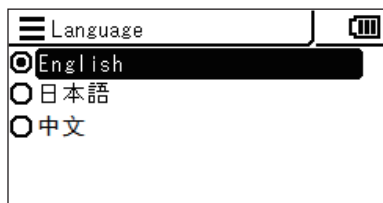

When the date and time have not been set
(page 58)



2. Daily Operation

Although the following messages may be displayed during daily operation, they do not indicate any abnormality.

Refer to the relevant page and follow the instruction.

Every time the power switch is set to OFF, this message is displayed to indicate that the instrument is saving settings.

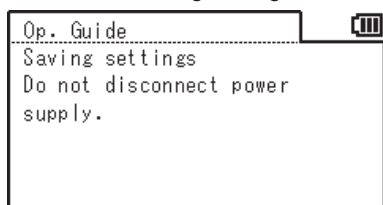

When the periodic calibration alert is set to ON and the instrument has passed the next calibration due date (page 52)

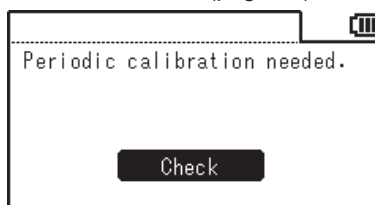

When the battery voltage is low (page 20)

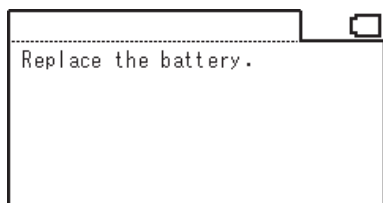

3. Error

When an error occurs in the instrument, the following message is displayed and the instrument tries a recovery operation. If the recovery fails, refer to the "Checking for Malfunction" section provided later in this manual.

When the memory check at power-on encounters an error

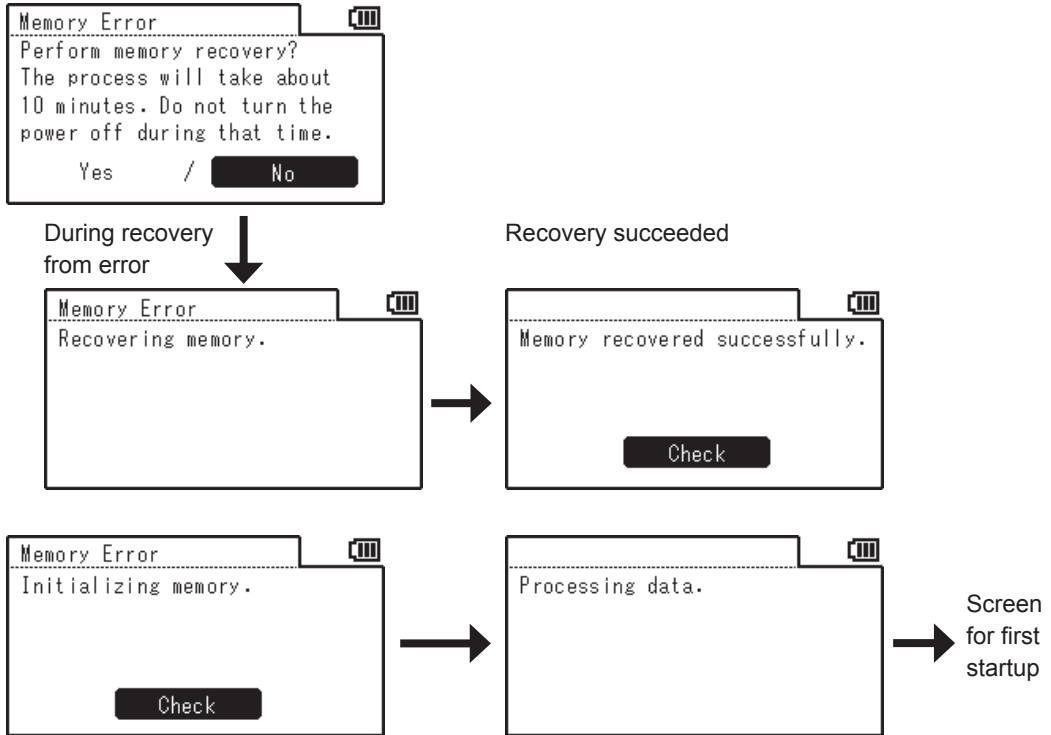

If the backup battery is out of charge, the settings will return to their default states.





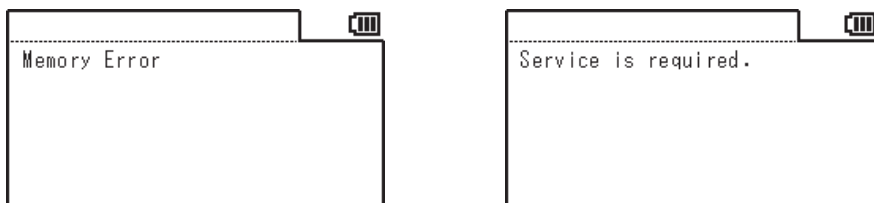

If the instrument cannot recover from the error and displays the following message, refer to the "Checking for Malfunction" section provided later in this manual.





Preparation

Installing Batteries

 **WARNING** (Failure to adhere to the following instructions may result in death or serious injury.)

-  Do not put the batteries into a fire and do not recharge, short-circuit, heat, or disassemble them. Doing so may cause the batteries to explode or leak, leading to a fire or an electric shock.
-  If leaked battery fluid gets in a persons eyes, wash the eyes with clean water without rubbing and then seek medical attention immediately. If leaked fluid comes in contact with hands or clothes, rinse it off thoroughly with water. Do not continue the use of a leaking battery.
-  When discarding the batteries used in the instrument, isolate the terminals with tape or other material. Otherwise, any contact with a metal object may cause heat, an explosion, or a fire. Make sure that the batteries are either disposed of or recycled correctly in accordance with local laws and regulations.
-  Do not continue the use of the instrument if it is damaged or if it produces smoke or odd smells. Doing so may cause a fire. In such situations, turn the power OFF immediately, disconnect the AC adapter from the AC outlet and/or remove the batteries, and contact the nearest KONICA MINOLTA-authorized service facility.
-  Do not touch or hold the batteries with wet hands. Doing so may cause an electric shock or a breakdown.

 **CAUTION** (Failure to adhere to the following instructions may result in injury or physical damage.)

-  Do not use any batteries other than those specified for the instrument. Do not use a new battery and an old battery or batteries of different types together. When loading the batteries in the instrument, ensure they are oriented according to the polarity indication (positive ⊕ and negative ⊖) on the instrument. Otherwise, the batteries may break or leak, resulting in a fire or injury, or contamination of the area.
-  Do not use wet batteries. Do not use the instrument while water remains in the battery compartment. This may cause the batteries to explode or produce heat, leading to a fire or injury.

Notes on Use



If the instrument will not be used for more than two weeks, remove the batteries from it. Otherwise, the batteries may leak, resulting in damage to the instrument.

To avoid unnecessary battery consumption, you can set the instrument to activate Auto Power Off when no operation is made for five minutes. For details, refer to page 50.

When both the batteries and AC adapter or PC are used, the power is supplied through the USB cable. This does not charge the batteries.

Battery Level Indicator

The battery level indicator is displayed at the upper right corner of the LCD screen.

-  **is lit:** The battery power is sufficient.
-  **is lit:** The battery power is low.
It is recommended to prepare new batteries or the AC adapter.
-  **is lit:** The batteries is not sufficient. The instrument cannot be used.
Replace the batteries with new ones or use the AC adapter.

Be sure to set the power switch to OFF before replacing the batteries or connecting the AC adapter.

Installing Batteries

1. Ensure that the power switch is set to OFF (○ side).

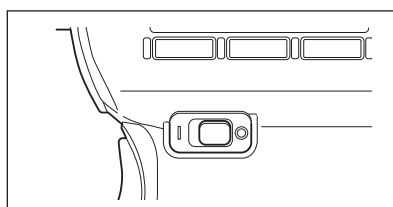

2. Hold down the ► mark on the battery chamber cover and open the cover by sliding it in the direction shown in the figure.

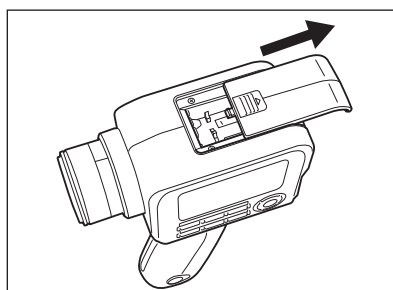

3. Install two AA batteries according to the polarity indication inside the chamber.

Do not touch the terminals inside the chamber with your fingers or short-circuit them. Doing so may cause a breakdown of the instrument. Use either of alkaline batteries or nickel-metal-hydride batteries.

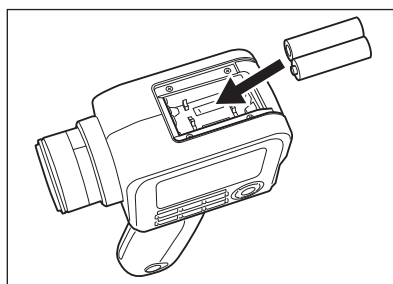



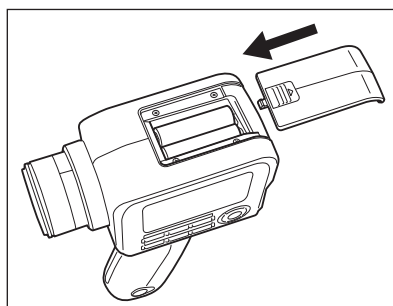



4. Close the battery chamber cover completely by sliding it in the direction shown in the figure until you hear a click.



Connecting the AC Adapter

You can use either of the optional AC adapter or two commercially-available AA batteries to supply power to the instrument. Select whichever way is most convenient according to your application.

 **WARNING** (Failure to adhere to the following instructions may result in death or serious injury.)

-  For the AC adapter, only use the optional AC adapter specified by KONICA MINOLTA (AC-A305J/L/M) and connect it to an indoor AC outlet of the rated voltage and frequency (100-240 VAC ~ 50/60 Hz). If another AC adapter or different voltage is used, it may result in the damage to the instrument or AC adapter or a fire or an electric shock.
-  If the instrument will not be used for a long time, disconnect the AC adapter from the AC outlet. Accumulated dirt or water on the prongs of the AC adapter's plug may cause a fire and should be removed.
-  Do not insert or disconnect the AC adapter with wet hands. Doing so may cause an electric shock.
-  Do not bend the USB cable by force, or twist or pull it. Do not put a heavy object on the cable and do not damage or modify it. A damaged cable may cause a fire or an electric shock.
-  Do not modify or disassemble the instrument or the AC adapter. Doing so may cause a fire or an electric shock.
-  Do not continue the use of the instrument and/or AC adapter if they are damaged or if they produce smoke or odd smells. Doing so may cause a fire. In such situations, turn the power OFF immediately, disconnect the AC adapter from the AC outlet and/or remove the batteries, and contact the nearest KONICA MINOLTA-authorized service facility.

 **CAUTION** (Failure to adhere to the following instructions may result in injury or physical damage.)

-  When using the AC adapter, provide an environment such that there is an outlet near the instrument and the power plug of the AC adapter can be easily plugged or unplugged.

Connection Procedure

- 1.** Ensure that the power switch of the instrument is set to OFF (○ side).

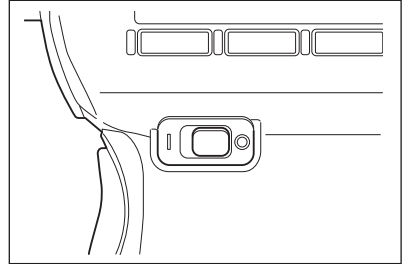

- 2.** Slide the connector protection cover and connect the USB cable to the USB connection terminal.

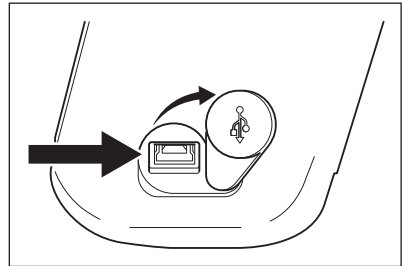

- 3.** Connect the USB cable to the AC adapter, and insert the power plug of the AC adapter into the AC outlet (100-240 VAC \sim 50/60 Hz).

Be sure to insert the power plug of the AC adapter and the USB cable securely and completely.

Turning Power ON (|)/OFF (○)

Setting the Power Switch to ON

1. Slide the power switch to the ON (|) side.

- ◆ The measurement screen appears on the LCD screen.

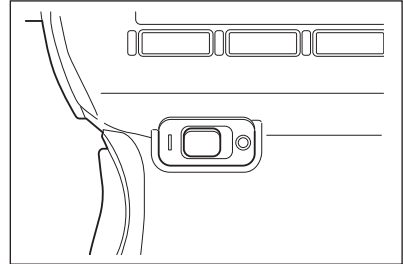

Setting the Power Switch to OFF

2. When measurement finishes and you want to turn the instrument OFF, slide the power switch to the OFF (○) side.

Do not disconnect the power supply after measurement until the measured value is displayed or while the "Saving settings..." message is displayed.

Doing so may corrupt stored data.

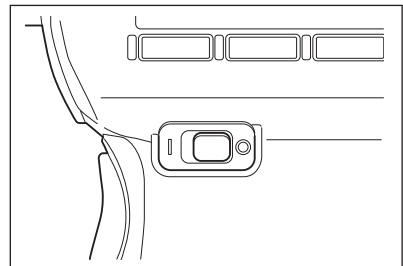

Wrist Strap

When you hold the instrument by hand, it is recommended to use the wrist strap.

Attaching the Wrist Strap

Pass the end of the wrist strap through the hook on the instrument and secure it with the buckle.

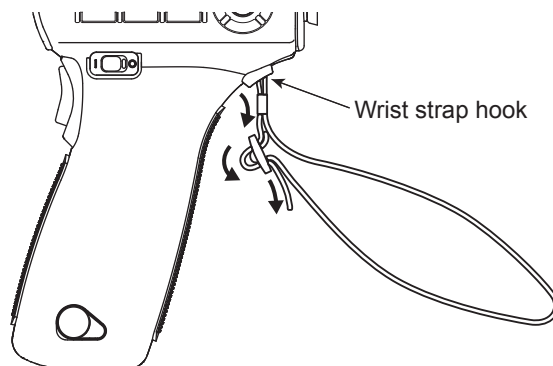

Holding the Instrument

Passing your hand through the wrist strap before holding the instrument prevents accidental dropping of the instrument.

Caution During Carrying

When carrying the instrument, do not hang it or swing it around by holding the wrist strap. The strap may break causing the instrument to fall, resulting in injury or the damage of the instrument or surrounding objects.

Be careful not to drop the instrument or hit it against anything and causing an impact.

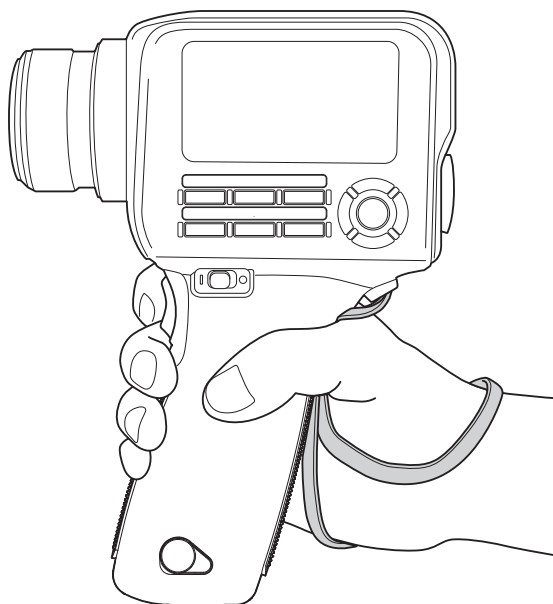

Mounting

When you mount the instrument onto a tripod or a jig, use the fixing screw hole on the bottom.

Tripod screw hole: Use this hole to mount the instrument onto a tripod. The screw hole depth is 6.5 mm.

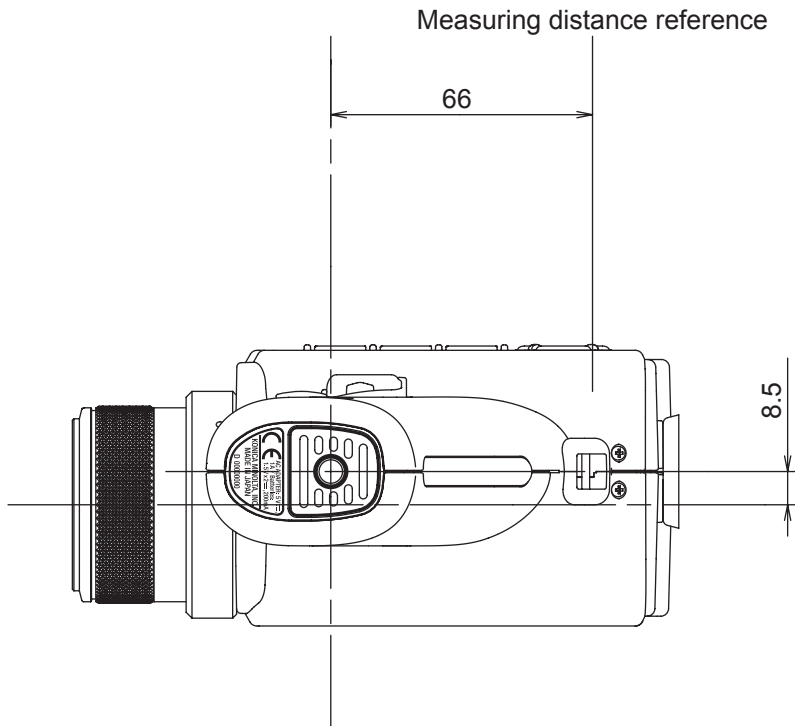

For dimension details, refer to page 102.

Mount the instrument securely on the tripod to prevent it falling over or dropping. Otherwise, injury or the damage of the instrument or surrounding objects may result.

Settings

Selecting the Integration Time

[Meas. Cond.] -
[Integ. Time]

Select the integration time according to the measurement purpose. You can select the integration time from the following two modes. When you require high repeatability, such as for measuring a low luminance object, select the mode offering a longer integration time.

* Factory setting: Auto

	Measurement time *1	Integration time *2
Auto *3	0.7 to 4.3 s	0.1 to 1.6 s
Manual	0.7 to 7.1 s	0.1 to 3.0 s

*1 Time required for actual measurement that is calculated as: "Integration time x 2 + Time for shutter opening and closing + Calculation time"

*2 Time required for the sensor to measure light (i.e. exposure time)

*3 The measurement time is automatically switched according to the luminance. The following tables show the integration time for measuring an "A" light source.

CS-150

L _v (cd/m ²)	Up to 1	Up to 2	Up to 5	Up to 50	50 or more
Integration time (s)	0.8	0.4	0.3	0.2	0.1

CS-160

L _v (cd/m ²)	Up to 8	Up to 10	Up to 20	Up to 50	Up to 500	500 or more
Integration time (s)	0.8	0.6	0.4	0.3	0.2	0.1

LS-150

L _v (cd/m ²)	Up to 0.2	Up to 0.3	Up to 0.6	Up to 1	Up to 2	Up to 5	Up to 8	Up to 10	Up to 100	100 or more
Integration time (s)	1.6	1.4	1.2	1.0	0.8	0.6	0.4	0.3	0.2	0.1

LS-160

L _v (cd/m ²)	Up to 1.5	Up to 3	Up to 4	Up to 5	Up to 8	Up to 10	Up to 20	Up to 50	Up to 100	100 or more
Integration time (s)	1.6	1.4	1.2	1.0	0.8	0.6	0.4	0.3	0.2	0.1

Operating Procedure

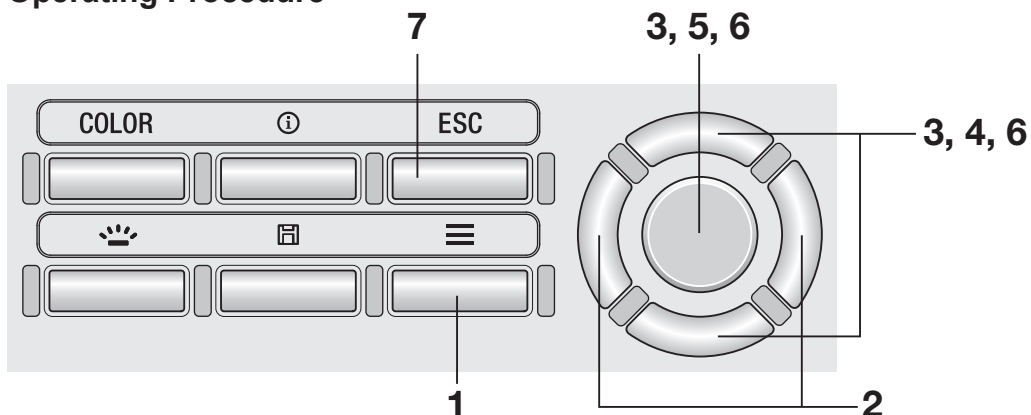

- 1. While the measurement screen is displayed, press the **MENU** key.**

The **setting screen** is displayed on the LCD screen.

2. Press the **[RIGHT]** key or **[LEFT]** key to display the **[Meas. Cond.]** screen.

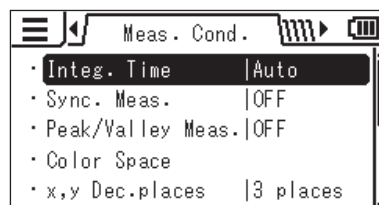

3. Press the **[UP]** key or **[DOWN]** key to select **[Integ. Time]** and then press the **[ENTER]** key.

4. The screen for selecting the integration time mode is displayed. Press the **[UP]** key or **[DOWN]** key to select whether to set the integration time mode to **[Auto]** or **[Manual]**.

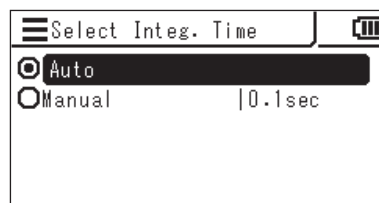

5. When you select **[Manual]**, press the **[ENTER]** key to display the screen for setting the integration time.

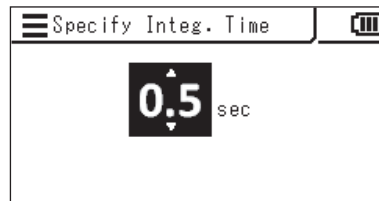

6. Press the **[UP]** key or **[DOWN]** key to set the integration time and then press the **[ENTER]** key.

* The setting range is between 0.1 and 3.0 seconds.

7. Press the **[ESC]** key.

The **measurement screen** is displayed on the LCD screen.

The measurement time setting is stored even when the power switch is set to OFF (○).

Setting the Synchronized Measurement Mode

[Meas. Cond.] -
[Sync. Meas.]

The synchronized measurement mode is a mode to perform measurement in synchronization with the flashing frequency of a light source that flashes at a constant cycle, such as the vertical synchronization frequency of a display unit.

* Synchronization frequency setting range: 20.00 to 200.00 Hz

* Factory setting: OFF

Operating Procedure

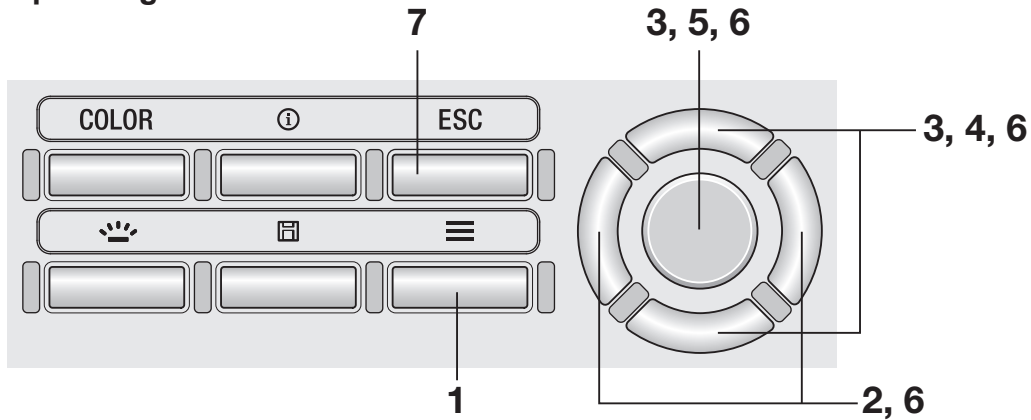

1. While the measurement screen is displayed, press the **[MENU]** key.

The **setting screen** is displayed on the LCD screen.

2. Press the **[RIGHT]** key or **[LEFT]** key to display the **[Meas. Cond.]** screen.

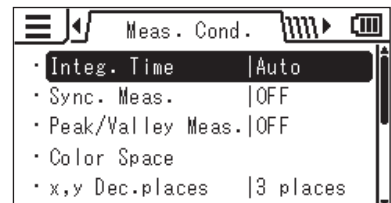

3. Press the **[UP]** key or **[DOWN]** key to select **[Sync. Meas.]** and then press the **[ENTER]** key.

4. The screen for selecting the synchronized measurement mode is displayed. Press the **[UP]** key or **[DOWN]** key to select whether to set the synchronized measurement to **[ON]** or **[OFF]**.

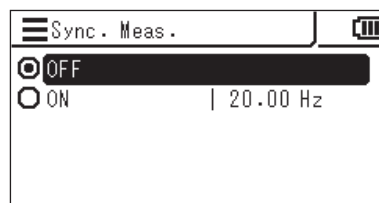

5. When you select **[ON]**, press the **[ENTER]** key to display the screen for setting the synchronization frequency.

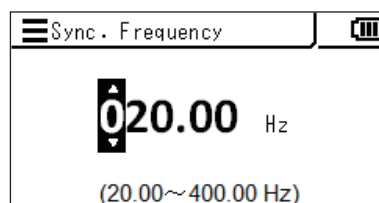

6. Press the **[UP]/[DOWN]** key and the **[RIGHT]/[LEFT]** key to set the synchronization frequency and then press the **[ENTER]** key.

If the entered value is out of the available range, an alert screen is displayed. Press the **[ENTER]** key to return to the previous screen and reset the value.

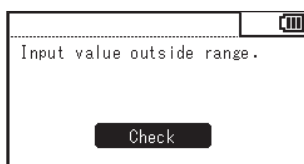

7. Press the **[ESC]** key twice.

The **measurement screen** is displayed on the LCD screen.

The synchronized measurement mode setting is stored even when the power switch is set to OFF (○).

When the synchronized measurement is set to ON, the specified integration time is disabled and the measurement is performed in the Auto mode.

Selecting the Maximum/Minimum Value

[Meas. Cond.] -
[Peak/Valley Meas.]

You can select a value to be obtained as the measurement result from the latest value, maximum value, and minimum value.

The maximum or minimum value is determined based on the L_V value.

* Measurement result selection: OFF, maximum value < Peak measurement >, or minimum value < Valley measurement >

* Factory setting: OFF

Operating Procedure

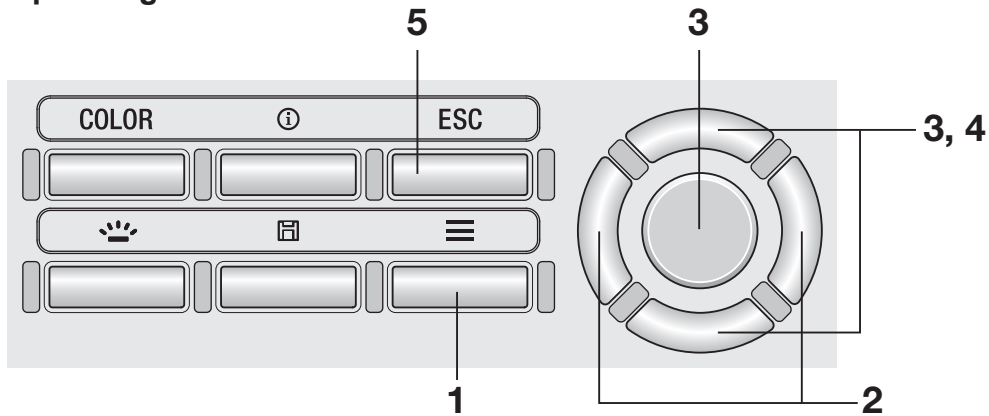

1. While the measurement screen is displayed, press the **[MENU]** key.

The **setting screen** is displayed on the LCD screen.

2. Press the **[RIGHT]** key or **[LEFT]** key to display the **[Meas. Cond.]** screen.

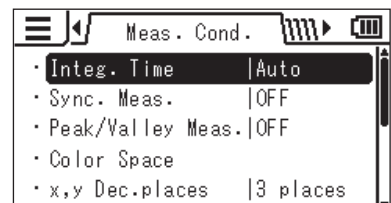

3. Press the **[UP]** key or **[DOWN]** key to select **[Peak/Valley Meas.]** and then press the **[ENTER]** key.

-
- 4.** The screen for selecting the **Peak/Valley measurement** is displayed. Press the **[UP]** key or **[DOWN]** key to select the measurement mode.

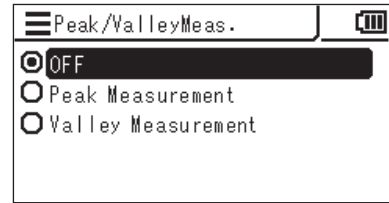

When < **Peak Measurement** > is selected, the maximum value of the measured values is shown as the measurement result.

When < **Valley Measurement** > is selected, the minimum value of the measured values is shown as the measurement result.

- 5.** Press the **[ESC]** key.

The **measurement screen** is displayed on the LCD screen.

Even when the Peak or Valley measurement has been set, normal measurement will be performed for the user calibration and target measurement.

The maximum/minimum value selection is stored even when the power switch is set to OFF (○).

Setting the Selectable Color Spaces

You can set color spaces that can be selected with the instrument.

* Factory setting: All options selected

Operating Procedure

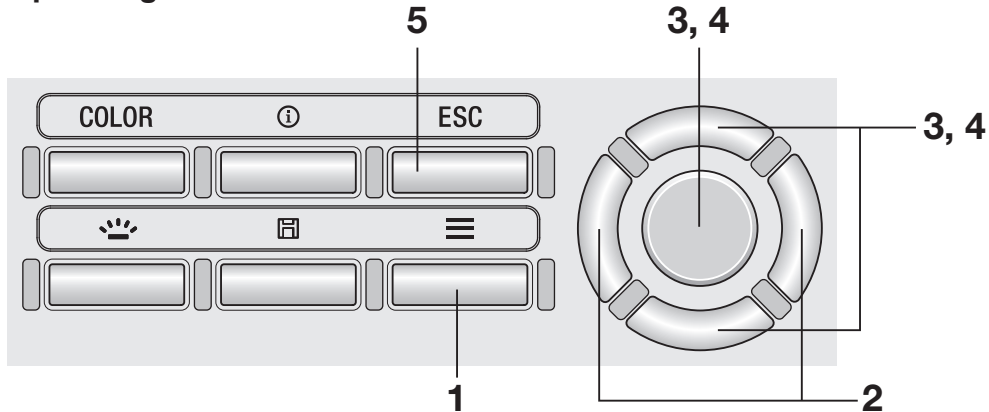

1. While the measurement screen is displayed, press the **MENU** key.

The **setting screen** is displayed on the LCD screen.

2. Press the **RIGHT** key or **LEFT** key to display the [Meas. Cond.] screen.

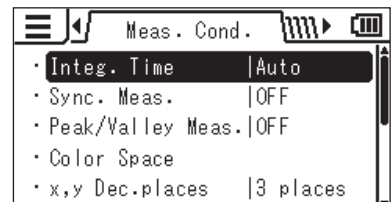

3. Press the **UP** key or **DOWN** key to select [Color Space] and then press the **ENTER** key.

-
4. The screen for selecting the color space is displayed. Press the **UP** key or **DOWN** key and **ENTER** key to set each color space to be selectable or not.

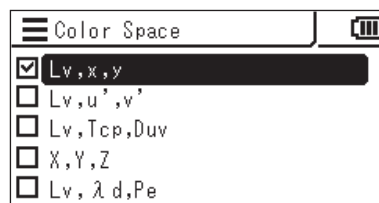

5. Press the **ESC** key.



The **measurement screen** is displayed on the LCD screen.

The selectable color space setting is stored even when the power switch is set to OFF (○).

Selecting the Color Space

The following color spaces are available.

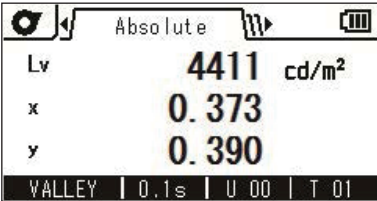
* Factory setting: L_vxy

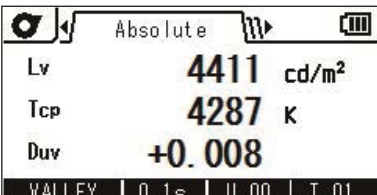
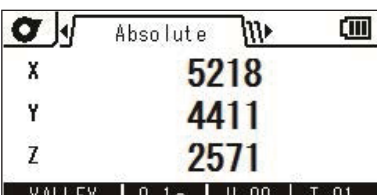
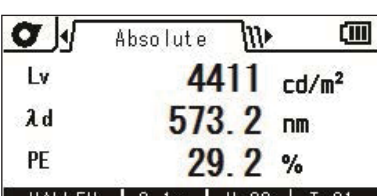
Color space	LCD screen display	Description
L_vxy		The result is displayed/output with luminance L_v and chromaticity coordinates x, y .
$L_vu'v'$		The result is displayed/output with luminance L_v and $u'v'$ chromaticity diagram (CIE 1976 UCS chromaticity diagram) coordinates u', v' .
$L_v T_{cp} duv$		The result is displayed/output with luminance L_v , correlated color temperature T_{cp} , and color difference from black body locus duv .
XYZ		The result is displayed/output with tristimulus values $X, Y,$ and Z .
Dominant wavelength*1 Excitation purity		The result is displayed/output with dominant wavelength λ_d .

*1 When the measured value is a non-spectral color, the value of the complementary wavelength is displayed. In this case, the symbol is also λ_d but a minus sign is added.

Operating Procedure

1

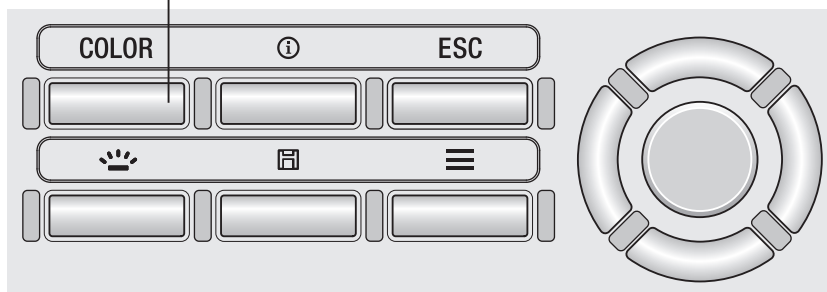

- 1. On the measurement screen, press the **COLOR** key and display a desired color space.**

Every time the **COLOR** key is pressed, the measurement screen is switched to display $L_v x y \rightarrow L_v u'v' \rightarrow L_v T_{cp} duv \rightarrow XYZ \rightarrow L_v \lambda_d P_e \rightarrow L_v x y$ and so on.

The color space setting is stored even when the power switch is set to OFF (O).

Selecting the Decimal Places for the Chromaticity Display [Meas. Cond.] - [x,y Dec.places]

You can select to use four or three decimal places for the chromaticity display. If the measured value displayed on the LCD screen fluctuates and is hard to read, select three decimal places.

* Number of decimal places for chromaticity display: 4 places or 3 places

* Factory setting: 4 places

Operating Procedure

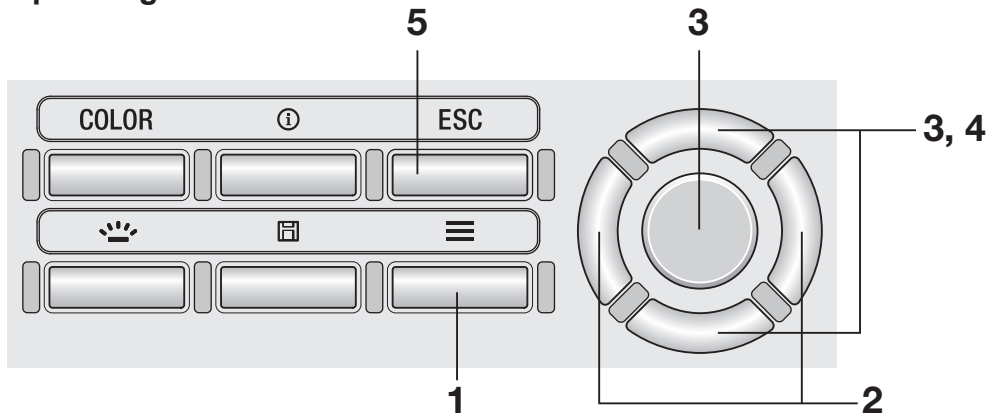

1. While the measurement screen is displayed, press the **[MENU]** key.

The **setting screen** is displayed on the LCD screen.

2. Press the **[RIGHT]** key or **[LEFT]** key to display the **[Meas. Cond.]** screen.

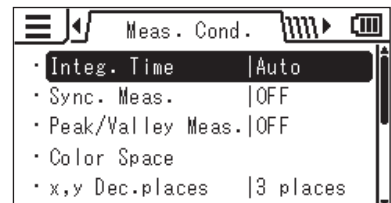

3. Press the **[UP]** key or **[DOWN]** key to select **[x,y Dec.places]** and then press the **[ENTER]** key.

-
4. The screen for selecting the number of decimal places for the chromaticity display is displayed. Press the **UP** key or **DOWN** key to select whether to display [3 places] or [4 places].

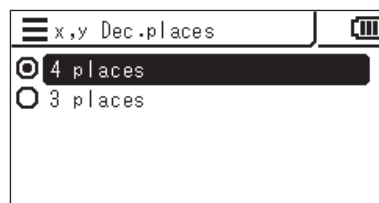

5. Press the **ESC** key.

The **measurement screen** is displayed on the LCD screen.

The setting of the number of decimal places for chromaticity display is stored even when the power switch is set to OFF (○).

Selecting the Color Correction Factor (C.C.F.)

[Meas. Cond.] -
[CCF]

If you know the color correction factor for the light source to be measured in advance, you can input the value into the instrument to display a corrected measured value.

* Factory setting: OFF

Operating Procedure

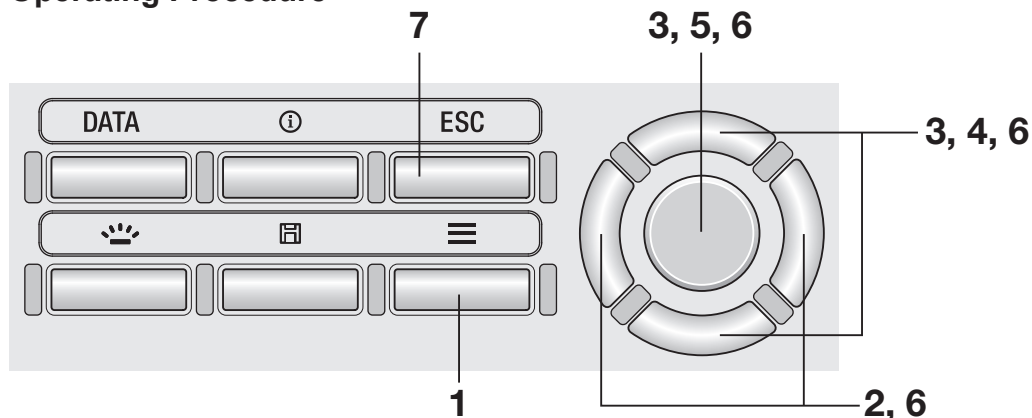

1. While the measurement screen is displayed, press the **MENU** key.

The **setting screen** is displayed on the LCD screen.

2. Press the **RIGHT** key or **LEFT** key to display the [Meas. Cond.] screen.

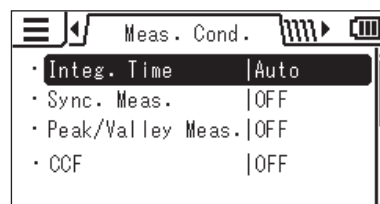

3. Press the **UP** key or **DOWN** key to select [CCF] and then press the **ENTER** key.

4. The screen for selecting whether to set CCF to ON or OFF is displayed. Press the **[UP]** key or **[DOWN]** key to select to set CCF to **[ON]** or **[OFF]**.

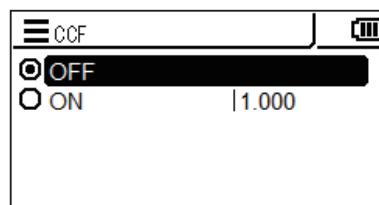

5. When you select **[ON]**, press the **[ENTER]** key to display the screen for setting the CCF value.

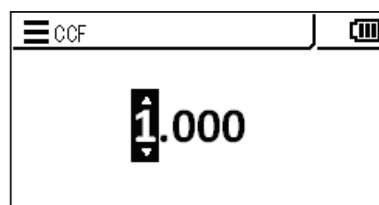

6. Press the **[UP]/[DOWN]** key and the **[RIGHT]/[LEFT]** key to set the CCF value and then press the **[ENTER]** key.

* The CCF setting range is between 0.001 and 9.999.

If the entered value is out of the available range, an alert screen is displayed. Press the **[ENTER]** key to return to the previous screen and reset the value.

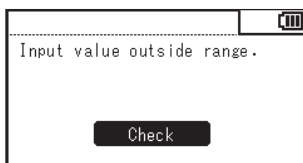

7. Press the **[ESC]** key twice.

The **measurement screen** is displayed on the LCD screen.

The CCF setting and value are stored even when the power switch is set to OFF (○).

Selecting the Close-up Lens

[Meas. Cond.] -
[Close-up Lens]

To measure an extremely small surface, you can use the optional close-up lens. For the procedure to attach the close-up lens, refer to the instruction manual of the close-up lens.

When the close-up lens is attached, it is necessary to correct the measured value by multiplying it by the transmittance of the lens. Since the correction value varies depending on the lens attached, you need to set the lens type on the instrument.

Setting the wrong lens type prevents proper measurement.

The following table shows the relationship between the close-up lens model and the setting on the instrument.

Attached lens	No lens attached	Close-up lens No. 153	Close-up lens No. 135	Close-up lens No. 122	Close-up lens No. 110
Setting	None	No. 153	No. 135	No. 122	No. 110

* Factory setting: None

Operating Procedure

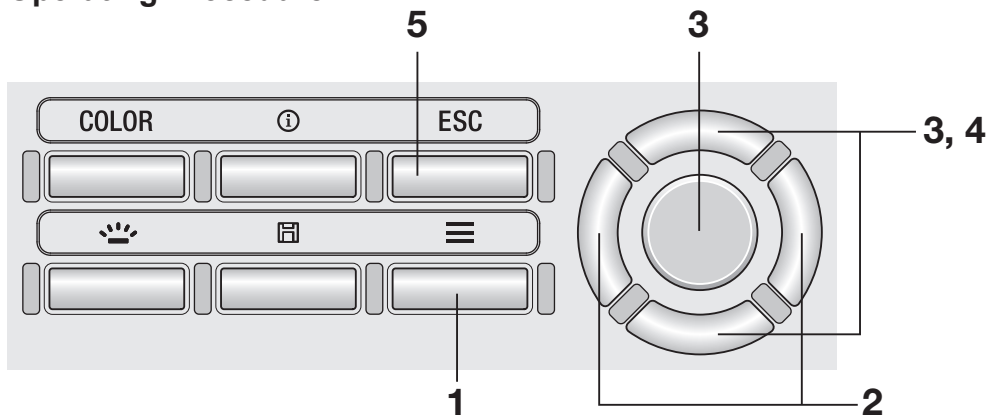

1. While the measurement screen is displayed, press the **[MENU]** key.

The **setting screen** is displayed on the LCD screen.

2. Press the **[RIGHT]** key or **[LEFT]** key to display the **[Meas. Cond.]** screen.

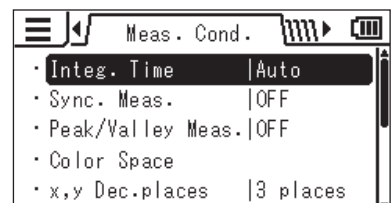

-
- 3.** Press the **[UP]** key or **[DOWN]** key to select **[Close-up Lens]** and then press the **[ENTER]** key.

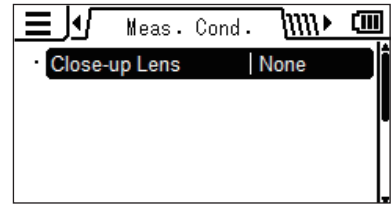

- 4.** The screen for selecting the type of the close-up lens is displayed. Press the **[UP]** key or **[DOWN]** key to select the lens to be used.

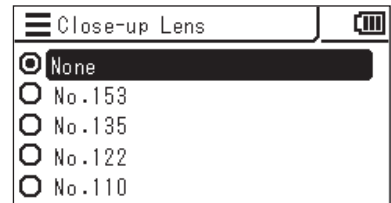

When close-up lens No. 110 is attached, select [No. 110]. When close-up lens No. 122 is attached, select [No. 122]. When nothing is attached in front of the objective lens, select [None].

- 5.** Press the **[ESC]** key.

The **measurement screen** is displayed on the LCD screen.

The lens type setting is stored even when the power switch is set to OFF (○).

Selecting the Measuring Button Function

[Options] -
[Meas. Button]

You can select the function of the Measuring button from "Standard" and "Toggle." The former performs measurement while the button is pressed and holds the last value when the button is released; and the latter starts measurement when the button is pressed and continues it until the button is pressed again.

* Measuring button function selection: Standard or Toggle

* Factory setting: Standard

Operating Procedure

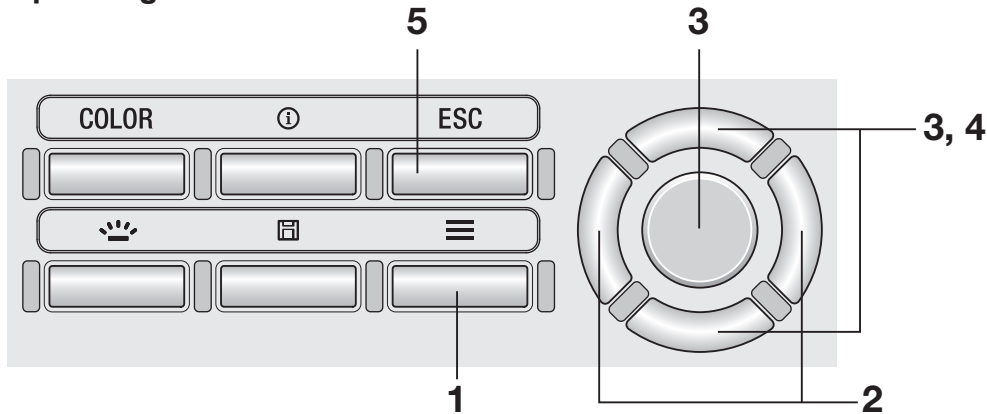

1. While the measurement screen is displayed, press the **[MENU]** key.

The **setting screen** is displayed on the LCD screen.

2. Press the **[RIGHT]** key or **[LEFT]** key to display the **[Options]** screen.

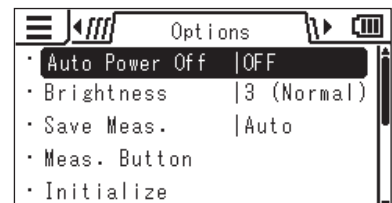

3. Press the **[UP]** key or **[DOWN]** key to select **[Meas. Button]** and then press the **[ENTER]** key.

-
- 4.** The screen for selecting single measurement (Standard) or continuous measurement (Toggle) is displayed. Press the **UP** key or **DOWN** key to select the desired function.

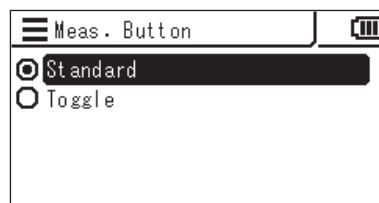

- 5.** Press the **ESC** key.

The **measurement screen** is displayed on the LCD screen.

The setting of the Measuring button function is stored even when the power switch is set to OFF (○).

Setting the Measurement Result Saving

[Options] -
[Save Meas.]

You can set whether the instrument saves measurement results automatically or not.

* Factory setting: Manual

Operating Procedure

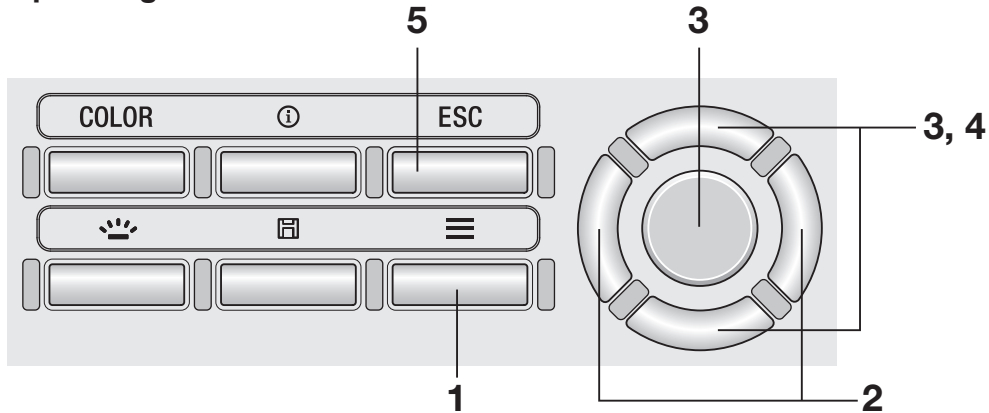

1. While the measurement screen is displayed, press the **MENU** key.

The **setting screen** is displayed on the LCD screen.

2. Press the **RIGHT** key or **LEFT** key to display the **[Options]** screen.

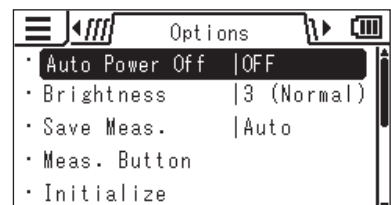

3. Press the **UP** key or **DOWN** key to select **[Save Meas.]** and then press the **ENTER** key.

-
- 4.** The screen for selecting automatic saving or manual saving is displayed. Press the **[UP]** key or **[DOWN]** key to select **[Auto]** or **[Manual]**.

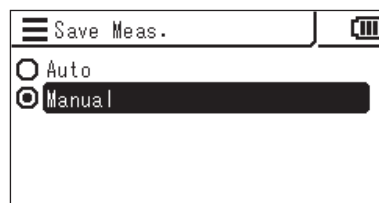

- 5.** Press the **[ESC]** key.

The **measurement screen** is displayed on the LCD screen.

The setting of measurement result saving is stored even when the power switch is set to OFF (○).

When **[Auto]** is selected, a measured value is saved into the memory for every measurement and the **[SAVE]** key becomes disabled.

When **[Manual]** is selected, a measured value is saved into the memory when the **[SAVE]** key is pressed after measurement.

In either case, the saved data can be checked from MENU.

Setting the Display Brightness

[Options] -
[Brightness]

You can set the brightness of the external LCD screen of the instrument.

* Factory setting: 3 (Normal)

Operating Procedure

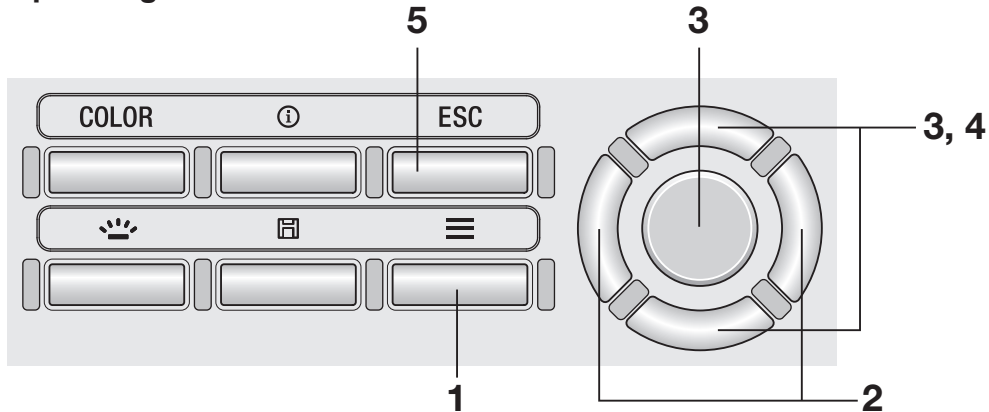

1. While the measurement screen is displayed, press the **MENU** key.

The **setting screen** is displayed on the LCD screen.

2. Press the **RIGHT** key or **LEFT** key to display the **[Options]** screen.

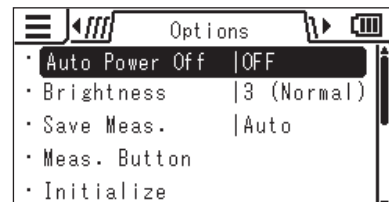

3. Press the **UP** key or **DOWN** key to select **[Brightness]** and then press the **ENTER** key.

4. The screen for selecting brightness is displayed. Press the **UP** key or **DOWN** key to select brightness.

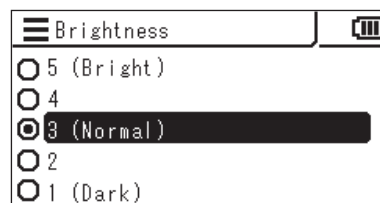

5. Press the **ESC** key.

The **measurement screen** is displayed on the LCD screen.

The brightness setting is stored even when the power switch is set to OFF (O).

Turning the Backlight ON/OFF

BACKLIGHT key

You can turn the backlight of the external LCD screen ON or OFF.

Operating Procedure

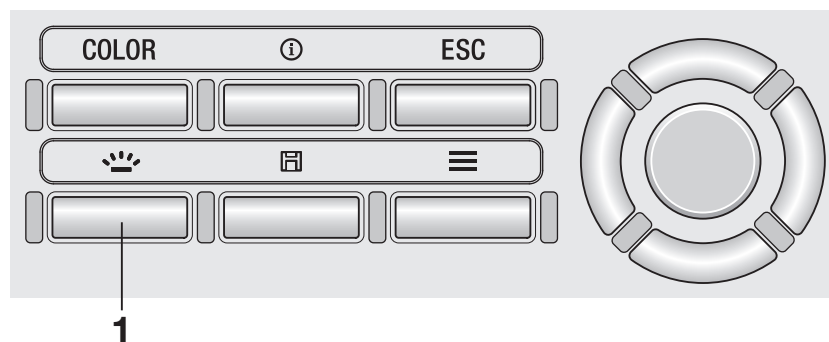

1. Press the **BACKLIGHT** key.

When the backlight is ON it turns OFF, and vice versa.

The backlight is turned OFF during measurement. During continuous measurement (Toggle), however, you can turn the backlight ON/OFF with this key.

Setting the Auto Power Off

[Options] -
[Auto Power Off]

To save battery, you can set the instrument to activate Auto Power Off when no operation or communication is made for five minutes.

* Factory setting: ON

Operating Procedure

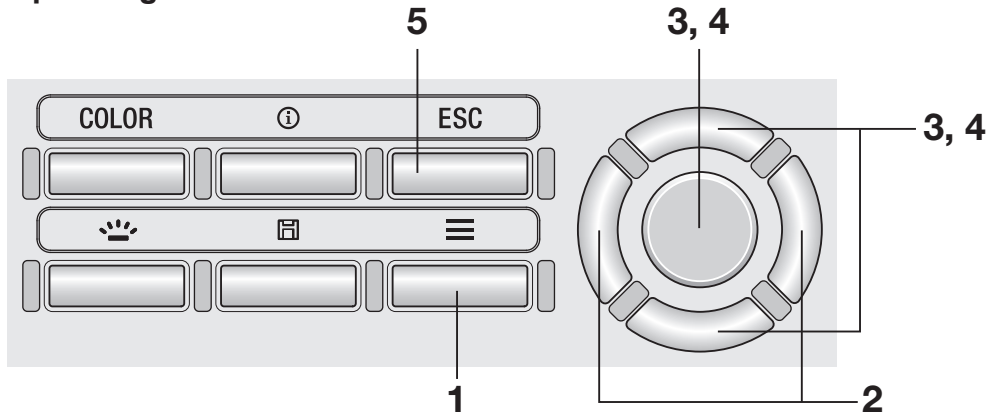

1. While the measurement screen is displayed, press the **[MENU]** key.

The **setting screen** is displayed on the LCD screen.

2. Press the **[RIGHT]** key or **[LEFT]** key to display the **[Options]** screen.

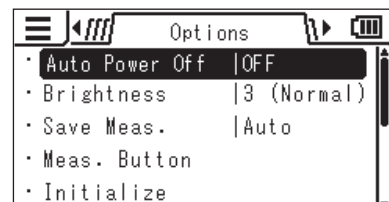

3. Press the **[UP]** key or **[DOWN]** key to select **[Auto Power Off]** and then press the **[ENTER]** key.

-
- 4.** The screen for selecting the Auto Power Off mode is displayed. Press the **UP** key or **DOWN** key to select to set the mode to **[ON]** or **[OFF]**, and then press the **ENTER** key.

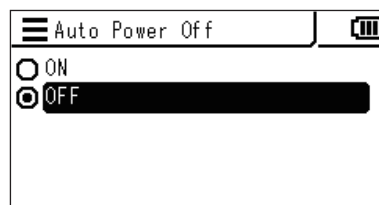

- 5.** Press the **ESC** key.

The **measurement screen** is displayed on the LCD screen.

The Auto Power Off mode setting is stored even when the power switch is set to OFF (○).

Setting the Periodic Calibration Alert Display

[Options] -
[Calib. Alert]

When a specific period of time has passed since the last calibration, the instrument displays a message to notify the recalibration time. You can disable this message.

* Factory setting: ON (enabled)

Operating Procedure

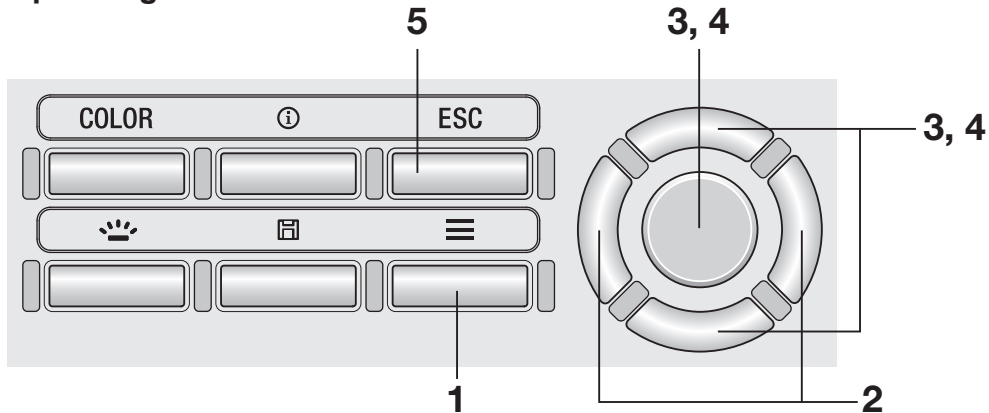

1. While the measurement screen is displayed, press the **[MENU]** key.

The **setting screen** is displayed on the LCD screen.

2. Press the **[RIGHT]** key or **[LEFT]** key to display the **[Options]** screen.

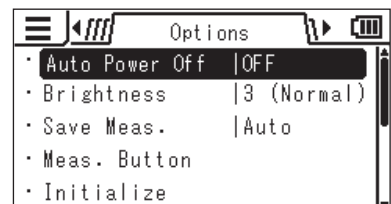

3. Press the **[UP]** key or **[DOWN]** key to select **[Calib. Alert]** and then press the **[ENTER]** key.



4. The screen for selecting whether or not to display the periodic calibration alert is displayed. Press the **UP** key or **DOWN** key to select **[ON]** (enabled) or **[OFF]** (disabled), and then press the **ENTER** key.

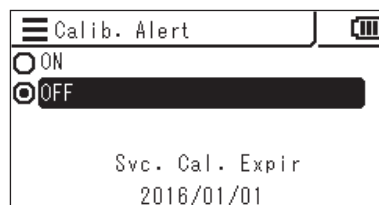

5. Press the **ESC** key.

The **measurement screen** is displayed on the LCD screen.

The periodic calibration alert setting is stored even when the power switch is set to OFF (○).

Alert screen notifying periodic calibration overdue

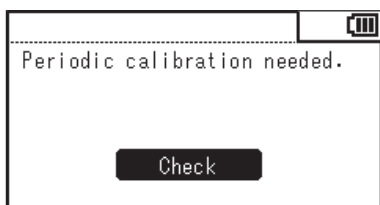

When the periodic calibration time arrives, contact a KONICA MINOLTA-authorized service facility.

Setting a Luminance Unit

[Options] -
[Luminance Unit]

Set the unit of luminance.

This screen is not displayed when Japanese is selected for the display language.

* Factory setting: cd/m²

Operating Procedure

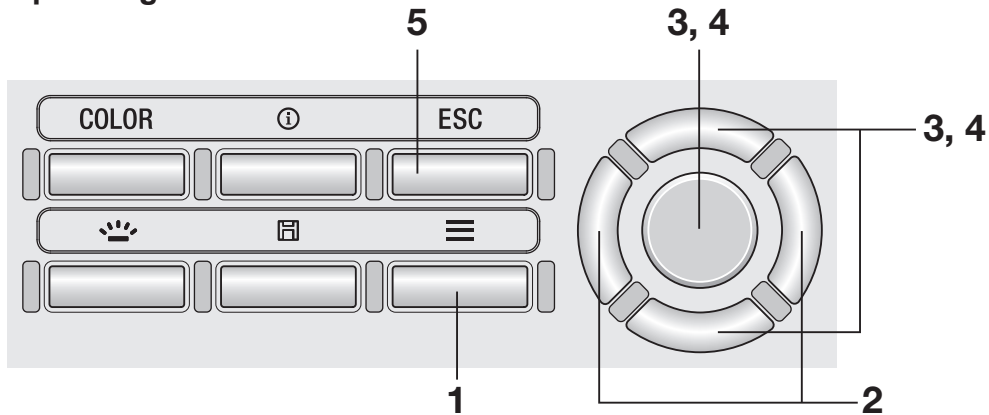

1. While the measurement screen is displayed, press the **MENU** key.

The **setting screen** is displayed on the LCD screen.

2. Press the **RIGHT** key or **LEFT** key to display the **[Options]** screen.

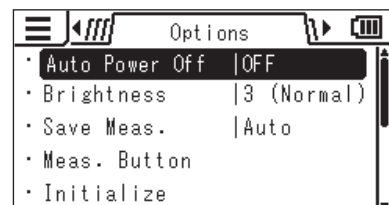

3. Press the **UP** key or **DOWN** key to select **[Luminance Unit]** and then press the **ENTER** key.



-
4. The screen for selecting the luminance unit is displayed. Press the **[UP]** key or **[DOWN]** key to select the unit and then press the **[ENTER]** key.

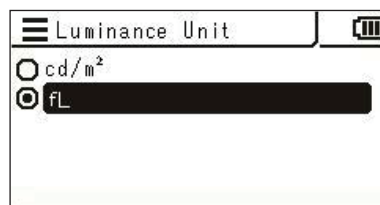

5. Press the **[ESC]** key.

The **measurement screen** is displayed on the LCD screen.

The luminance unit setting is stored even when the power switch is set to OFF (○).

Initializing the Settings

[Options] - [Initialize]

You can reset the settings back to the factory settings. The initialization does not delete the measured values, targets, and user calibration information stored in the instrument.

Operating Procedure

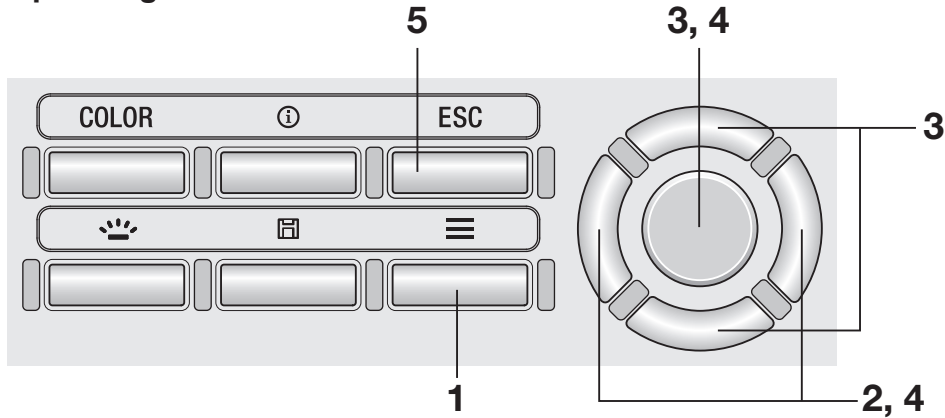

1. While the measurement screen is displayed, press the **MENU** key.

The **setting screen** is displayed on the LCD screen.

2. Press the **RIGHT** key or **LEFT** key to display the **[Options]** screen.

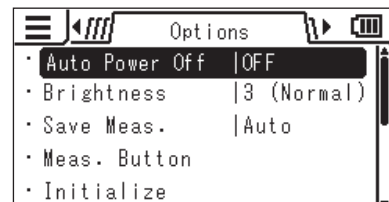

3. Press the **UP** key or **DOWN** key to select **[Initialize]** and then press the **ENTER** key.

-
- 4.** The screen for selecting whether or not to initialize the instrument is displayed. Press the **RIGHT** key or **LEFT** key to select the option, and then press the **ENTER** key.

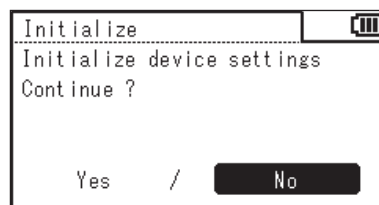

- 5.** Press the **ESC** key twice.

The **measurement screen** is displayed on the LCD screen.

Setting the Internal Clock [Options] - [Date/Time]

The instrument contains an internal clock to record the measurement date and time. Although this measurement date and time are not displayed on the instrument, they can be output together with the measured value when the instrument is controlled from a PC. They can be displayed together with the measured value when the data management software CS-S20 is used.

Operating Procedure

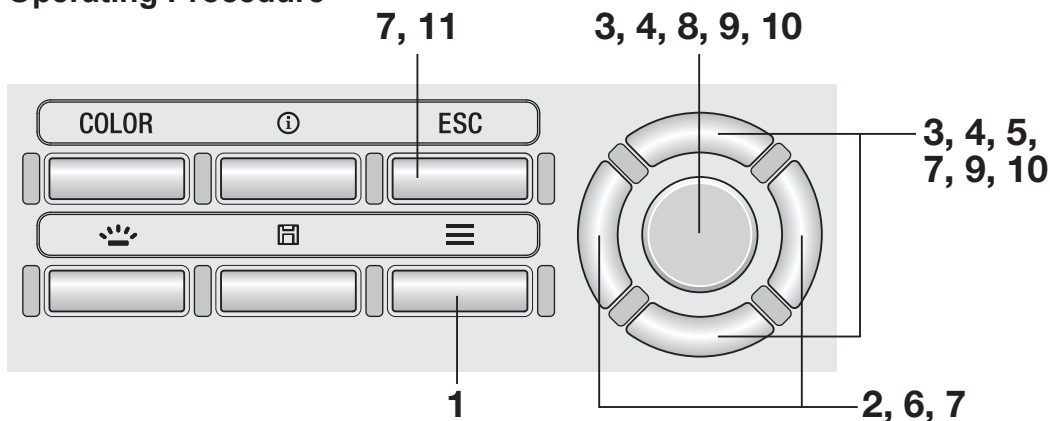

1. While the measurement screen is displayed, press the **MENU** key.

The **setting screen** is displayed on the LCD screen.

2. Press the **RIGHT** key or **LEFT** key to display the **[Options]** screen.

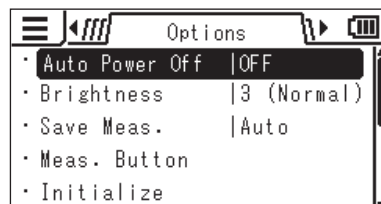

3. Press the **UP** key or **DOWN** key to select **[Date/Time]** and then press the **ENTER** key.



4. Press the **[UP]** key or **[DOWN]** key to select **[Date/Time]** and then press the **[ENTER]** key.

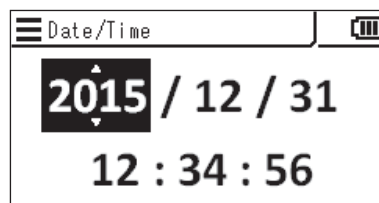

5. Press the **[UP]** key or **[DOWN]** key to set the desired value.

Holding down the key changes the value continuously.

6. Press the **[RIGHT]** key to move the cursor to the next item.

Pressing the **[LEFT]** key moves the cursor to the previous item.

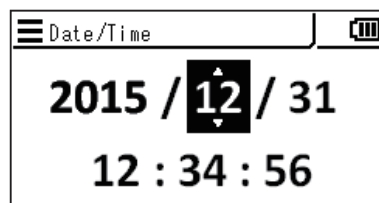

7. Repeat steps 5 and 6 for the necessary items.

The available range of years is from 2015 to 2099. To cancel the setting in the middle of the procedure, press the **[ESC]** key.

8. Press the **[ENTER]** key.

The LCD screen changes to the **[Date/Time]** screen and the internal clock is set.

9. Press the **[UP]** key or **[DOWN]** key to select **[Date Format]** and then press the **[ENTER]** key.

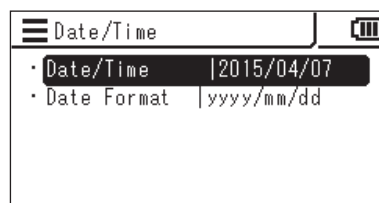

10. Press the **[UP]** key or **[DOWN]** key to select a desired date display format and then press the **[ENTER]** key.

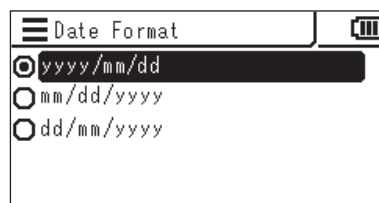

11. Press the **[ESC]** key twice.

The measurement screen is displayed on the LCD screen.

Selecting the Display Language

[Options] -
[Language]

You can select the language displayed on the external LCD screen of the instrument.

Operating Procedure

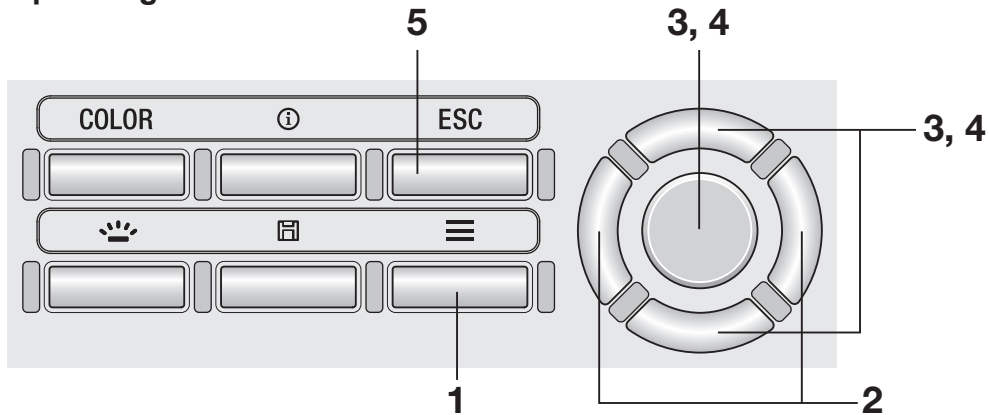

1. While the measurement screen is displayed, press the **[MENU]** key.

The **setting screen** is displayed on the LCD screen.

2. Press the **[RIGHT]** key or **[LEFT]** key to display the **[Options]** screen.

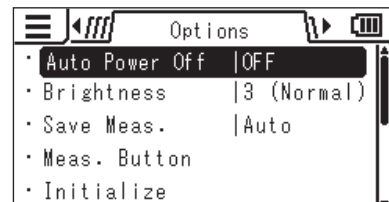

3. Press the **[UP]** key or **[DOWN]** key to select **[Language]** and then press the **[ENTER]** key.



-
- 4.** The screen for selecting the language is displayed. Press the **UP** key or **DOWN** key to select the language to be displayed, and then press the **ENTER** key.

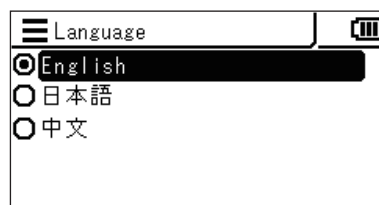

- 5.** Press the **ESC** key.

The **measurement screen** is displayed on the LCD screen.

The language setting is stored even when the power switch is set to OFF (○).

Checking the Instrument Information

[Options] -
[Instrument Info]

Operating Procedure

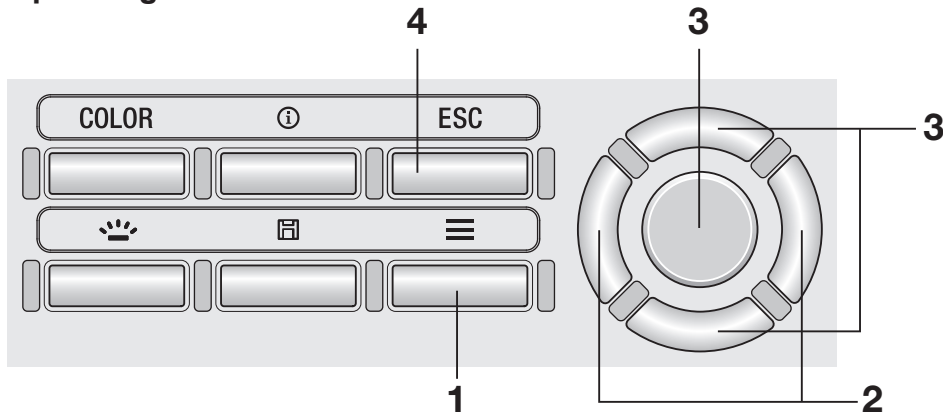

1. While the measurement screen is displayed, press the **MENU** key.

The **setting screen** is displayed on the LCD screen.

2. Press the **RIGHT** key or **LEFT** key to display the [Options] screen.

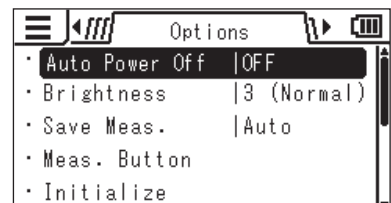

3. Press the **UP** key or **DOWN** key to select [Instrument Info] and then press the **ENTER** key.

Version and other information about the instrument are displayed on the LCD screen.

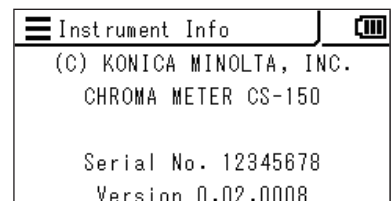
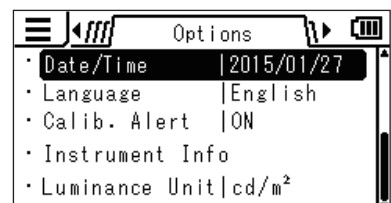

4. Press the **ESC** key twice.

The **measurement screen** is displayed on the LCD screen.

Measurement Preparation

Calibration

Calibration Channels

This instrument has calibration channels numbered from CH00 to CH10 (11 channels in total).

CH00 is a channel for performing measurement in accordance with the Konica Minolta calibration standard. It is preset with correction coefficients for Konica Minolta calibration which cannot be changed by the user.

Users can set the following item to each of CH01 through CH10.

1. User calibration correction coefficient

The user calibration correction coefficients are used in common in one calibration channel for each measurement mode of $L_v \times y$, $L_v u'v'$, $L_v T_{cp} duv$, $X Y Z$, and dominant wavelength.

User Calibration

User calibration allows users to set their own correction coefficients to the calibration channel of the instrument by specifying calibration values (L_v, x, y ; L_v, u', v' ; or X, Y, Z) on the instrument. After setting, the value corrected with the specified correction coefficients will be displayed/output for every measurement.

You can use user calibration to apply the following correction to measurement based on the specified correction coefficients.

1. Correct the difference in the reading due to the inconsistency between the CIE 1931 color matching functions and spectral sensitivity.
2. Correct the difference in the readings between the instruments used simultaneously.

The user calibration offered by the instrument is a single-color calibration. To perform an RGB or RGB+W matrix calibration, you need to use the data management software CS-S20. It ensures accurate measurement of luminance and chromaticity near the calibration light source.

- When you obtain the calibration value by measuring the calibration light source with a measurement reference device, be sure to set the reference device and this instrument at the same position and angle from the calibration light source and measure the same measuring area. The instrument may not be calibrated properly if the measurement conditions are different from those of the reference device.
- During the measurement, use a constant-voltage power supply for illuminating the calibration light source to ensure conditions are as stable as possible.

User calibration can be performed for every calibration channel except for CH00.

There are two methods to perform user calibration:

1. **By measurement**(page 66 and 67)
2. **By selecting stored data**.....(page 68 and 69)

The procedures are described below.

You cannot perform user calibration for calibration channel CH00.

(CH00 is a calibration channel for performing measurement in accordance with the Konica Minolta calibration standard.)

The user calibration correction coefficients are used in common for each color space of $L_v x y$, $L_v u'v'$, $L_v T_{cp} duv$, $X Y Z$ and dominant wavelength.

Performing User Calibration

[User Calibr.] -
[Measure and Register]

1. By Measurement

Operating Procedure

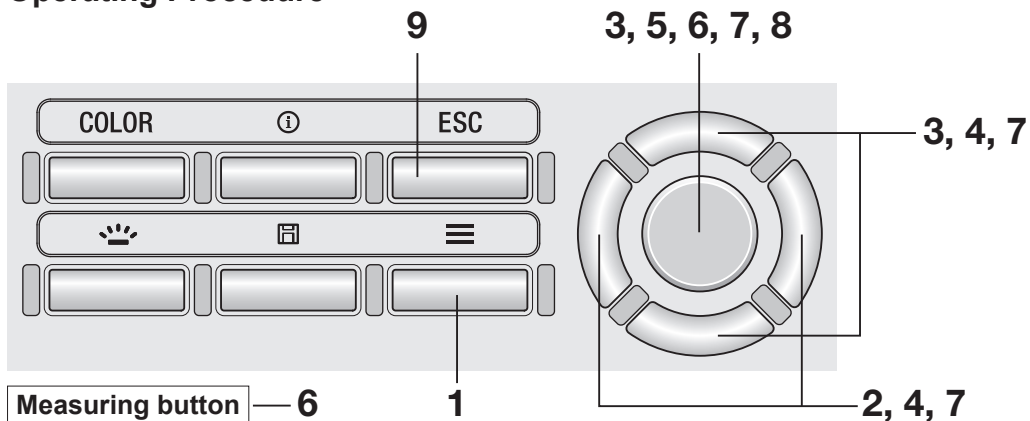

1. While the measurement screen is displayed, press the **[MENU]** key.

The **setting screen** is displayed on the LCD screen.

2. Press the **[RIGHT]** key or **[LEFT]** key to display the **[User Calibr.]** screen.

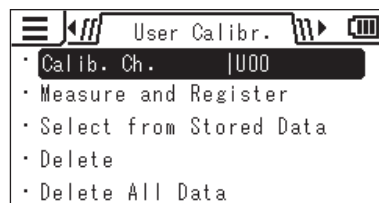

3. Press the **[UP]** key or **[DOWN]** key to select **[Measure and Register]** and then press the **[ENTER]** key.

4. The screen for selecting the calibration channel is displayed. Press the **[UP]** key or **[DOWN]** key to select the channel to register.

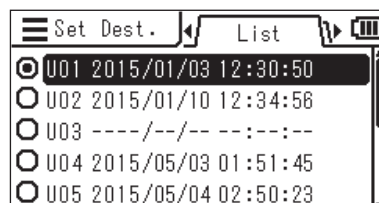

You can check the details of the current data by pressing the **RIGHT** key or **LEFT** key.

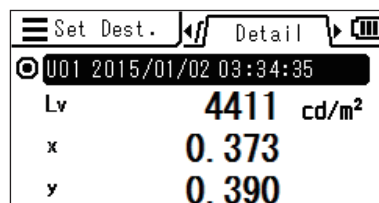

5. Press the **ENTER key.**

When "1. Measure: Press MEAS, 2. Register: Press ENTER" and "Check" are displayed, press the **ENTER** key again.



6. Press the Measuring button to perform measurement. When the measured value is displayed, press the **ENTER key.**

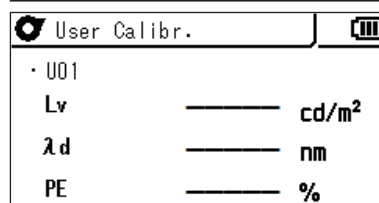

7. Press the **UP/**DOWN** key and the **RIGHT**/**LEFT** key to set values as the user calibration standard, and then press the **ENTER** key.**

(If the entered value is out of the available setting range, the screen returns to the value entry screen. Enter another value.)

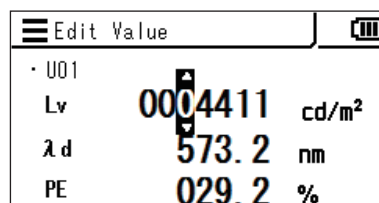
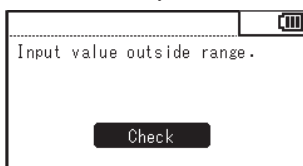
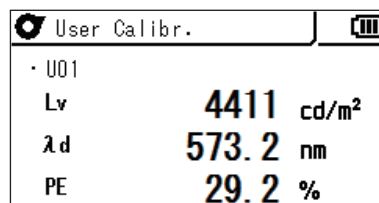

8. Press the **ENTER key on the confirmation screen to return to the menu screen.**

9. Press the **ESC key.**

The **measurement screen** is displayed on the LCD screen.

The specified values are stored even when the power switch is set to OFF (○).

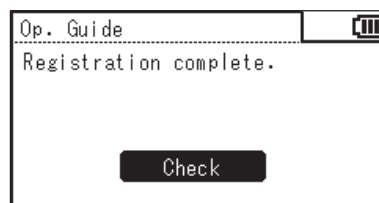

2. By Selecting Stored Data

Operating Procedure

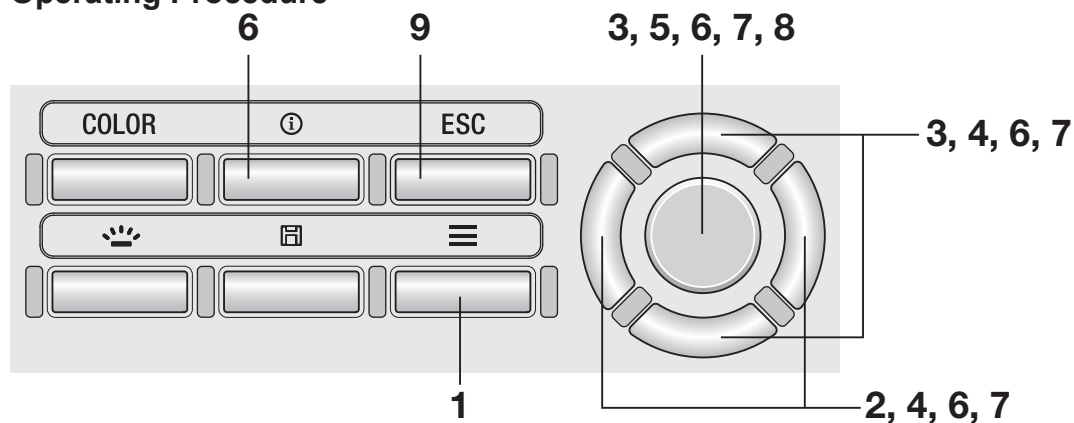

1. While the measurement screen is displayed, press the **[MENU]** key.

The **setting screen** is displayed on the LCD screen.

2. Press the **[RIGHT]** key or **[LEFT]** key to display the **[User Calibr.]** screen.

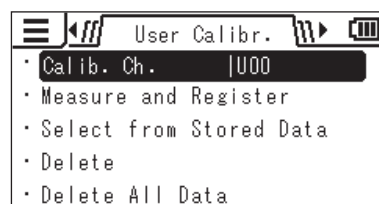

3. Press the **[UP]** key or **[DOWN]** key to select **[Select from Stored Data]** and then press the **[ENTER]** key.

4. The screen for selecting the calibration channel is displayed. Press the **[UP]** key or **[DOWN]** key to select the channel of the calibration standard to register.

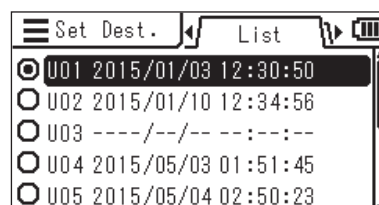

You can check the details of the current data by pressing the **[RIGHT]** key or **[LEFT]** key.

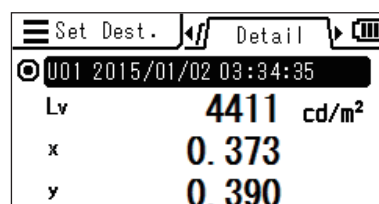

5. Press the **ENTER key.**

The screen for selecting from a list of measured values is displayed.

6. Press the **UP key or **DOWN** key to select the measured value used as a calibration standard, and then press the **ENTER** key.**

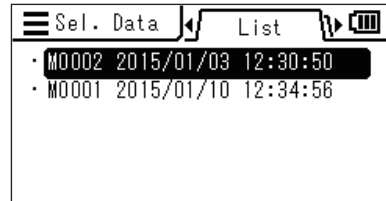

You can check the details of the stored data by pressing the **RIGHT** key or **LEFT** key. You can check the measurement condition, target, user calibration value, etc. by pressing the **INFO** key. When no measured value has been stored, the following alert screen is displayed. You need to save a measured value first.

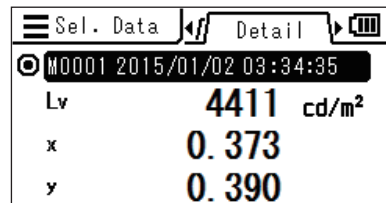

7. Press the **UP/**DOWN** key and the **RIGHT**/**LEFT** key to set values as the user calibration standard, and then press the **ENTER** key.**

(If the entered value is out of the available setting range, the screen returns to the value entry screen. Enter another value.)

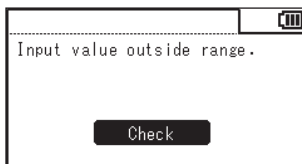
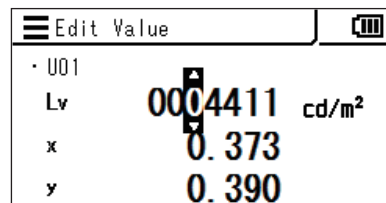

8. Press the **ENTER key on the confirmation screen to return to the menu screen.**

9. Press the **ESC key.**

The **measurement screen** is displayed on the LCD screen. The specified values are stored even when the power switch is set to OFF (○).

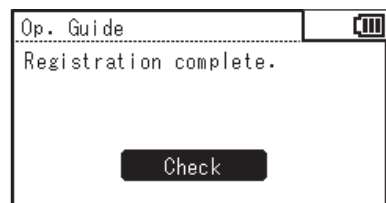

Calibration Value Input Rule

- The available setting values are those within the following ranges.

<CS/LS-150>

$$0 \leq X \leq 999900$$

$$0 \leq Y \leq 999900$$

$$0 \leq Z \leq 999900$$

$$0 \leq L_v \leq 999900$$

<CS/LS-160>

$$0 \leq X \leq 9999000$$

$$0 \leq Y \leq 9999000$$

$$0 \leq Z \leq 9999000$$

$$0 \leq L_v \leq 9999000$$

<CS-150/160>

$$0 \leq x < 1$$

$$0 < y < 1$$

$$x+y \leq 1$$

$$1563 \leq T_{cp} \leq 99990$$

$$-0.1 \leq duv \leq 0.1$$

$$366.0 \leq \lambda_d \leq 698.0$$

$$-569.0 \leq \lambda_d \leq -494.0$$

$$0.0 \leq P_e \leq 100.0$$

Setting/Changing the Target

Target

A target is the value used as a reference to determine how much the measured value differs from it. A target can be set by the following methods:

1. **By measurement and registration**
2. **By selecting stored data**
3. **By entering values**

The target is used in common for each measurement mode of $L_v x y$, $L_v u'v'$, $L_v T_{cp} duv$, $X Y Z$, and dominant wavelength.

When no target has been set, "----" is displayed.

1. By Measurement and Registration

Operating Procedure

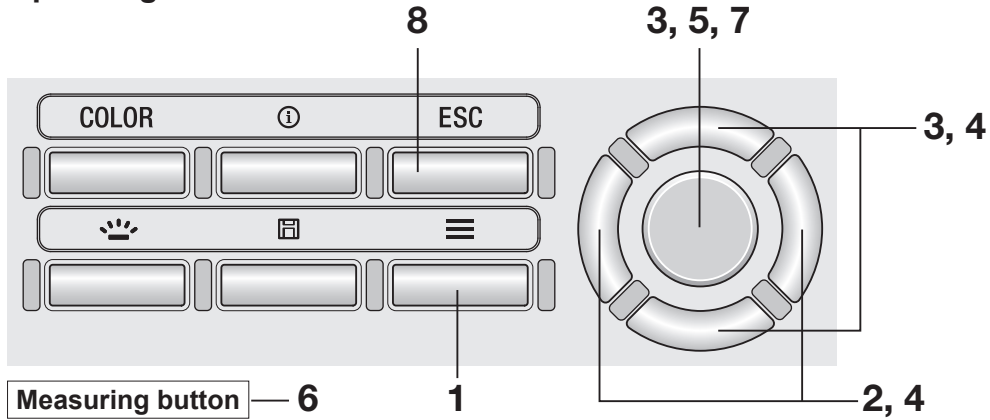

1. While the measurement screen is displayed, press the **MENU** key.

The **setting screen** is displayed on the LCD screen.

2. Press the **RIGHT** key or **LEFT** key to display the [Target] screen.

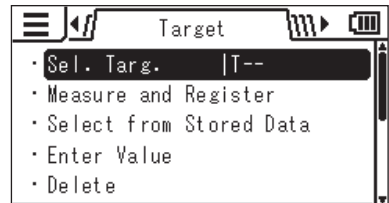

3. Press the **UP** key or **DOWN** key to select [Measure and Register] and then press the **ENTER** key.

4. The screen for selecting the target to be registered is displayed. Press the **UP** key or **DOWN** key to select the target.

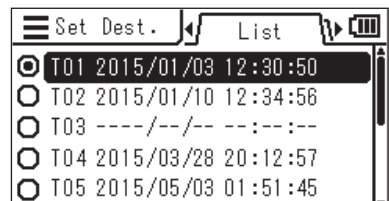

Measurement Preparation TARGET

You can check the details of the current data by pressing the **RIGHT** key or **LEFT** key.

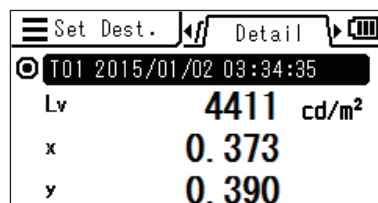

5. Press the **ENTER key.**

When "1. Measure: Press MEAS, 2. Register: Press ENTER" and "Check" are displayed, press the **ENTER** key again.



6. Every time you press the Measuring button and perform measurement, the measured value is displayed as a target.

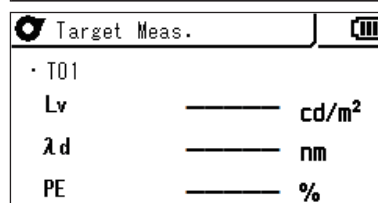

7. When an appropriate target is obtained, press the **ENTER key. When "Registration complete." is displayed, press the **ENTER** key to return to the menu screen.**

When no measured value has been obtained yet and you attempt to register a value, an alert screen is displayed. You need to perform measurement first.

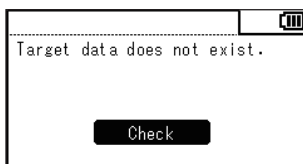
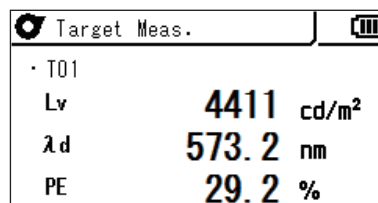

8. Press the **ESC key.**

The **measurement screen** is displayed on the LCD screen.

The specified values are stored even when the power switch is set to OFF (○).

2. By Selecting Stored Data

Operating Procedure

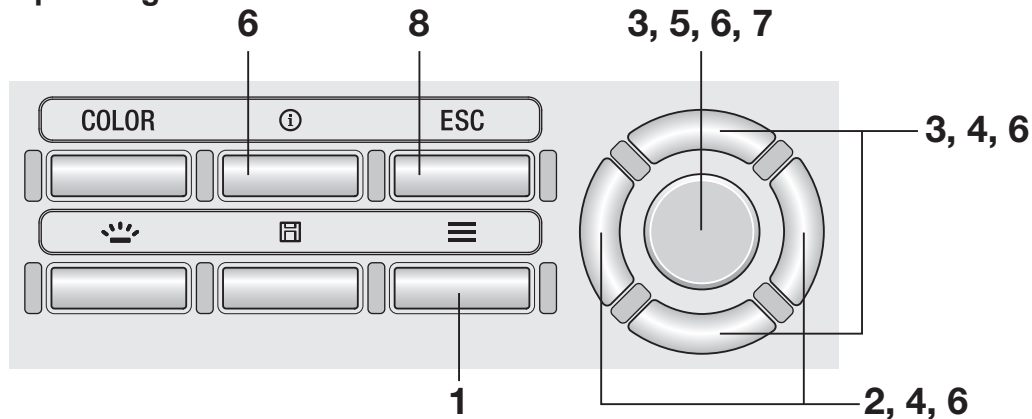

1. While the measurement screen is displayed, press the **MENU** key.

The **setting screen** is displayed on the LCD screen.

2. Press the **RIGHT** key or **LEFT** key to display the [Target] screen.

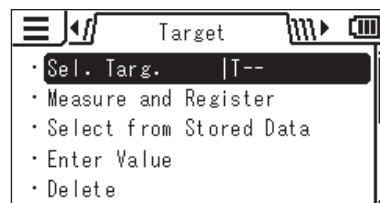

3. Press the **UP** key or **DOWN** key to select [Select from Stored Data] and then press the **ENTER** key.

4. The screen for selecting the target to be registered is displayed. Press the **UP** key or **DOWN** key to select the target.

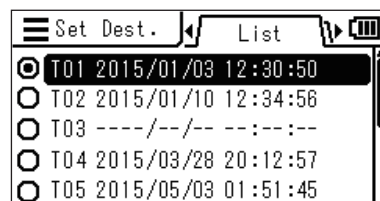

You can check the details of the current data by pressing the **RIGHT** key or **LEFT** key.

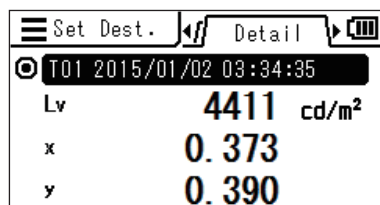

5. Press the **ENTER** key.

The screen for selecting from a list of measured values is displayed.

6. Press the **UP** key or **DOWN** key to select the measured value data used as a target, and then press the **ENTER** key.

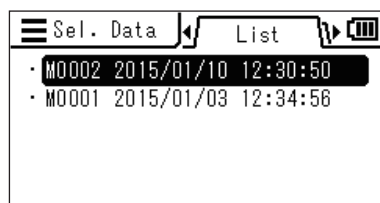

You can check the details of the selected data by pressing the **RIGHT** key or **LEFT** key.

You can check the measurement condition, target, user calibration value, etc. by pressing the **INFO** key.

When no measured value has been stored yet, the following alert screen is displayed. You need to save a measured value first.

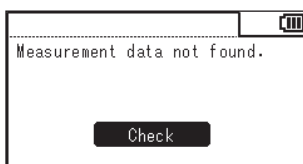
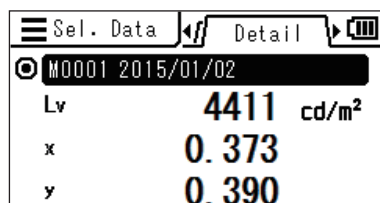

7. Press the **ENTER** key on the confirmation screen to return to the menu screen.



8. Press the **ESC** key.

The **measurement screen** is displayed on the LCD screen.

The specified values are stored even when the power switch is set to OFF (○).

3. By Entering Values

Operating Procedure

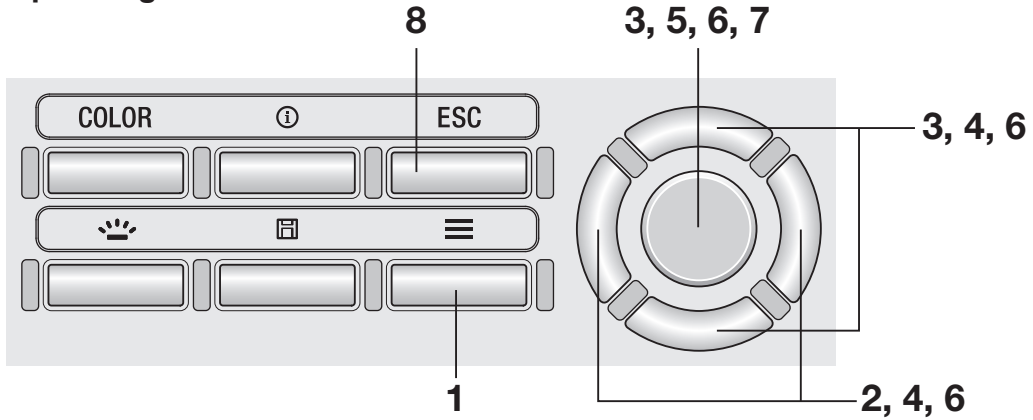

1. While the measurement screen is displayed, press the **MENU** key.

The **setting** screen is displayed on the LCD screen.

2. Press the **RIGHT** key or **LEFT** key to display the [Target] screen.

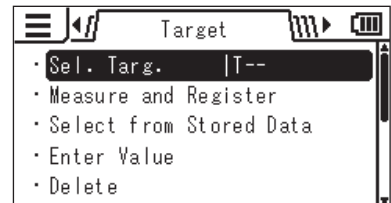

3. Press the **UP** key or **DOWN** key to select [Enter Value] and then press the **ENTER** key.

4. The screen for selecting the target to be registered is displayed. Press the **UP** key or **DOWN** key to select the target.

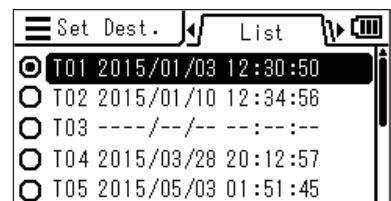

You can check the details of the current data by pressing the **RIGHT** key or **LEFT** key.

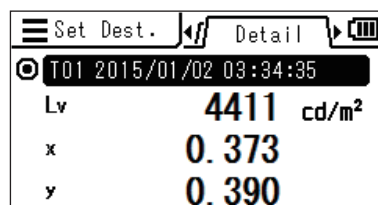

5. Press the **ENTER key.**

The screen for entering a target is displayed.

6. Press the **UP/**DOWN** key and the **RIGHT**/**LEFT** key to set values and then press the **ENTER** key.**

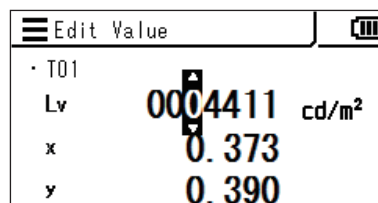

7. Press the **ENTER key on the confirmation screen to return to the menu screen.**

(If the entered value is out of the available setting range, the screen returns to the value entry screen. Enter another value.)

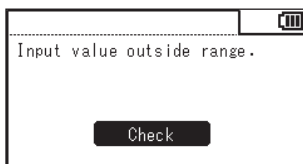
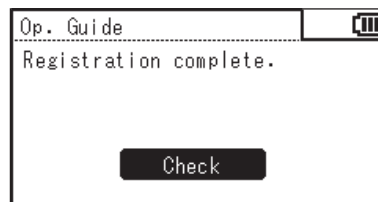

8. Press the **ESC key.**

The **measurement screen** is displayed on the LCD screen.

The specified values are stored even when the power switch is set to OFF (○).

Measurement

Selecting and Checking the Target/Calibration Channel

INFO key

You can select or check the measured values being stored by following the procedure below. (This function is intended for selecting or checking the values stored for [Target] or [User Calibr.])

Operating Procedure 1

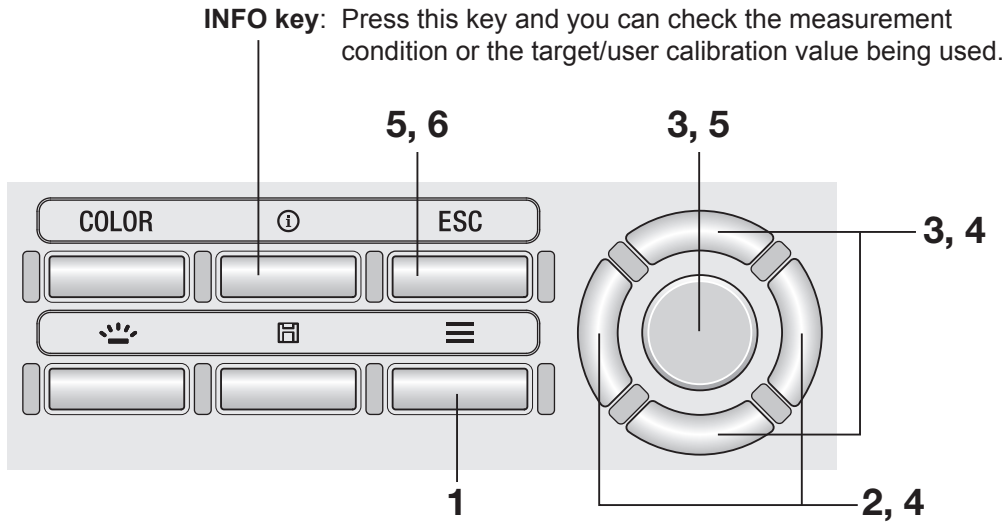

Operating Procedure 2

1. While the measurement screen is displayed, press the **MENU** key.

The **setting** screen is displayed on the LCD screen.

2. Press the **RIGHT** key or **LEFT** key to display the [Target] or [User Calibr.] screen.

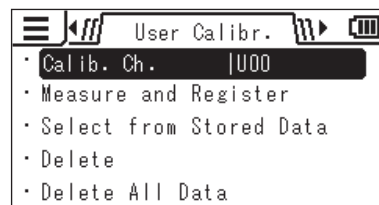
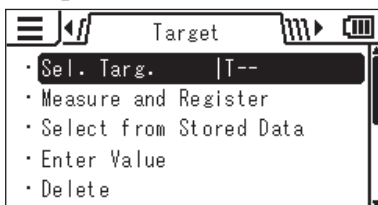

3. Press the **UP** key or **DOWN** key to select [Sel. Targ.] or [Calib. Ch.] and then press the **ENTER** key.

4. The list of stored values is displayed. The currently selected item is marked. Press the **UP** key or **DOWN** key to select an item you want to select or check.

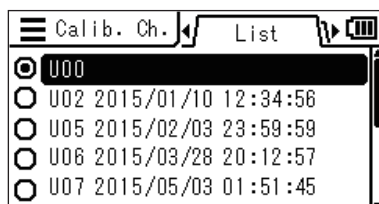
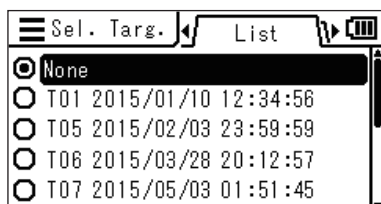

You can see the details of the selected item by pressing the **RIGHT** key.

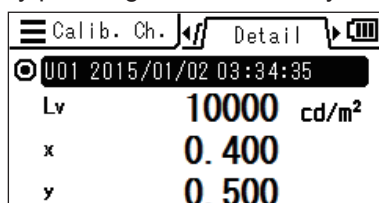
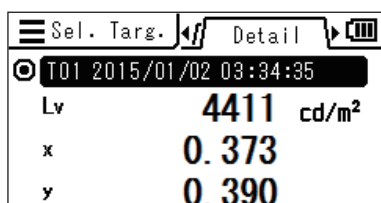

5. When you select an item and press the **ENTER** key, the current target or calibration channel is changed to the selected one, and the screen returns to the menu screen.

When you press the **ESC** key, the screen returns to the menu screen without changing the current target/ calibration channel.

6. Press the **ESC** key.

The measurement screen is displayed on the LCD screen.

Measurement

Operating Procedure

- Determine whether to use the close-up lens (optional accessory) by considering the size of the object to be measured and the measuring distance.**

Refer to the table below for the measuring distance and circle diameter. When the close-up lens is attached, you need to set the lens type on the instrument. (Refer to page 42.)

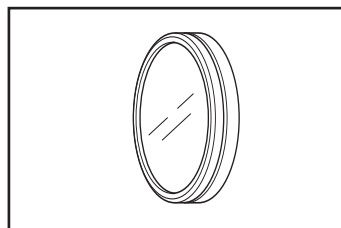

Measuring distance and area

(Unit: mm)

(Measuring angle)	Minimum area ϕ		Maximum area ϕ		Shortest distance	Longest distance
	1/3°	1°	1/3°	1°		
No close-up lens	4.5	14.4	∞	∞	1012	∞
Close-up lens No. 153	2.5	8.0	5.9	18.8	627	1219
Close-up lens No. 135	1.6	5.2	2.7	8.6	455	625
Close-up lens No. 122	1.0	3.2	1.3	4.3	331	378
Close-up lens No. 110	0.4	1.3	0.5	1.5	213	215

* The measuring distance is the distance from the measuring distance reference mark on the instrument.

Measuring circle diameter vs. measuring distance

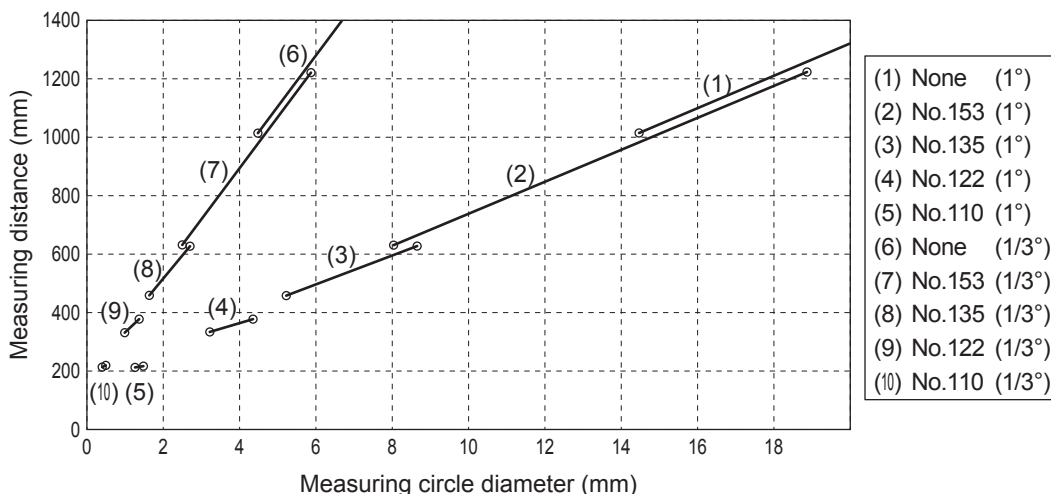

- Turn the visibility adjustment ring on the viewfinder to adjust the visibility.**

Observe the object to be measured through the viewfinder and adjust the ring so that the measuring circle is seen clearly. (Refer to page 14.)

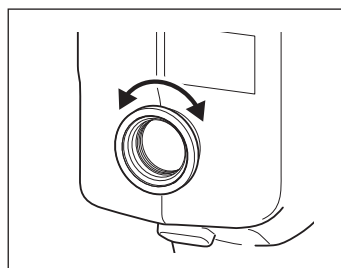

3. Turn the focus adjustment ring on the objective lens to adjust the focus.

Observe the object to be measured through the viewfinder and adjust the ring so that the image of the object around the measuring circle is seen clearly.

Ensure that only the section to be measured of the object is included in the measuring circle. If the circle includes any other unnecessary section, the measurement cannot be performed properly.

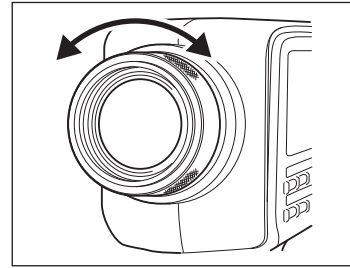

4. While the menu screen or target setting screen is displayed, press the **ESC** key.

The **measurement screen** is displayed on the LCD screen.

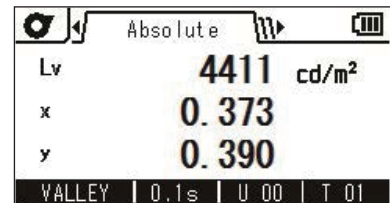

5. Press the Measuring button.

Hold the instrument securely so that the object does not move out of the measuring circle when the Measuring button is pressed.

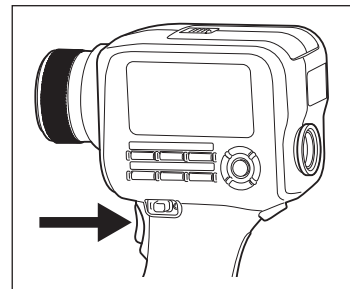

The L_v value is displayed inside the viewfinder. This L_v value is displayed regardless of the setting of the color space displayed on the LCD screen. The measurement result is displayed on the LCD screen.

The L_v value is shown as an absolute value, difference (\pm), or ratio (%) according to the display setting.

After the measurement, do not set the power switch to OFF until the measured value is displayed. Doing so may corrupt stored data.

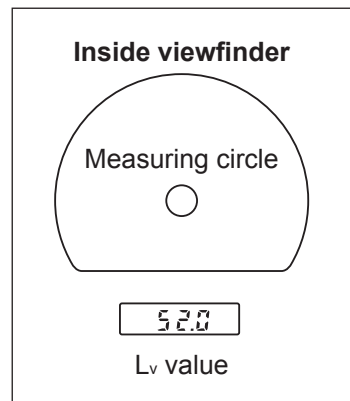

When the function of the Measuring button is set to Standard with long integration time and the Measuring button is released before measurement finishes, the measurement is canceled and "---" is displayed.

Selecting the Absolute Value/Difference/Ratio Display

LEFT/
RIGHT key

You can select to display the measured value as an absolute value (ABS), a difference (DIFF) or a ratio (RATIO). The displayed values vary depending on the color space. To display a difference or a ratio, you need to set a target (Refer to page 71.). When no target has been set, "--" is displayed.

* Factory setting: Absol. (ABS)

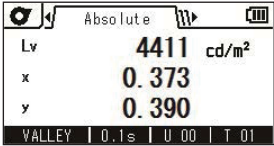
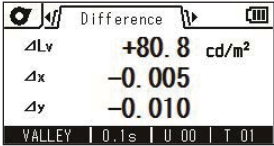
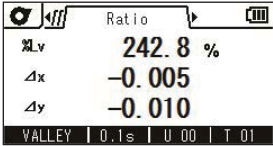
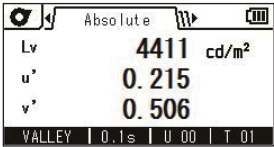
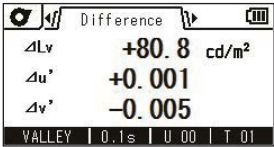
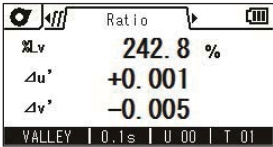
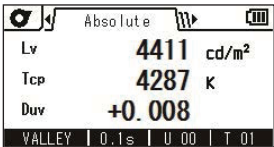
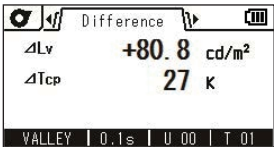
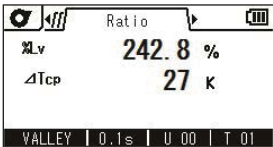
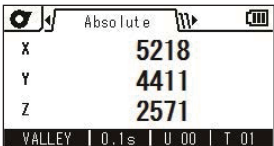
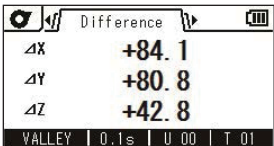
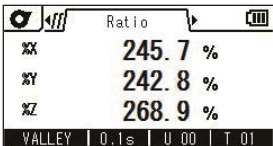
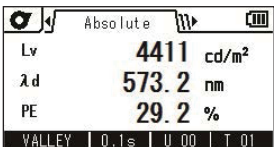
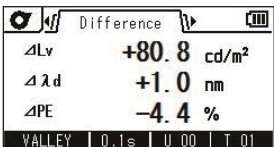
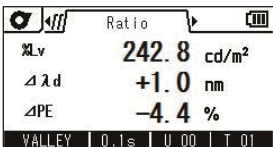
Color space	Display on the Absol. (ABS)/Diff. (DIFF)/Ratio (RATIO) tab		
$L_v x y$	L_v, x, y 	$\Delta L_v, \Delta x, \Delta y$ 	$\%L_v, \Delta x, \Delta y$ 
$L_v u' v'$	L_v, u', v' 	$\Delta L_v, \Delta u', \Delta v'$ 	$\%L_v, \Delta u', \Delta v'$ 
$L_v T_{cp} duv$	L_v, T_{cp}, duv 	$\Delta L_v, \Delta T_{cp}$ 	$\%L_v, \Delta T_{cp}$ 
XYZ	X, Y, Z 	$\Delta X, \Delta Y, \Delta Z$ 	$\%X, \%Y, \%Z$ 
L_v Dominant wavelength Excitation purity	L_v, λ_d, P_e 	$\Delta L_v, \Delta \lambda_d, \Delta P_e * 1$ 	$\%L_v, \Delta \lambda_d, \Delta P_e * 1$ 

*1 Even when either of the measured value or target or both are complementary wavelengths, the difference between the values is displayed. The symbol for this case is also $\Delta \lambda_d$.

Measurement ABS/DIFF/RATIO

Operating Procedure

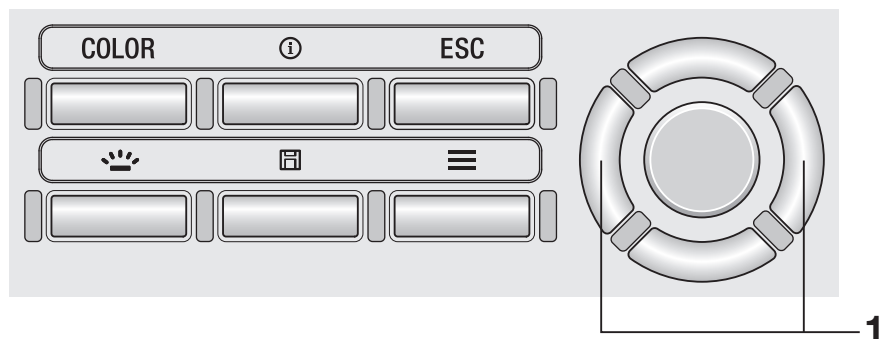

1. On the measurement screen, press the **RIGHT** key or **LEFT** key and tab switches between **[Absolute]** ↔ **[Difference]** ↔ **[Ratio]**.

Absolute	
Lv	4411 cd/m ²
x	0.373
y	0.390
VALLEY 0.1s U 00 T 01	



Difference	
ΔLv	+80.8 cd/m ²
Δx	-0.005
Δy	-0.010
VALLEY 0.1s U 00 T 01	



Ratio	
%Lv	242.8 %
Δx	-0.005
Δy	-0.010
VALLEY 0.1s U 00 T 01	

Checking the Measurement Result

[Meas. Result] -
[Check]

You can check the measured values being stored by following the procedure below.

Operating Procedure

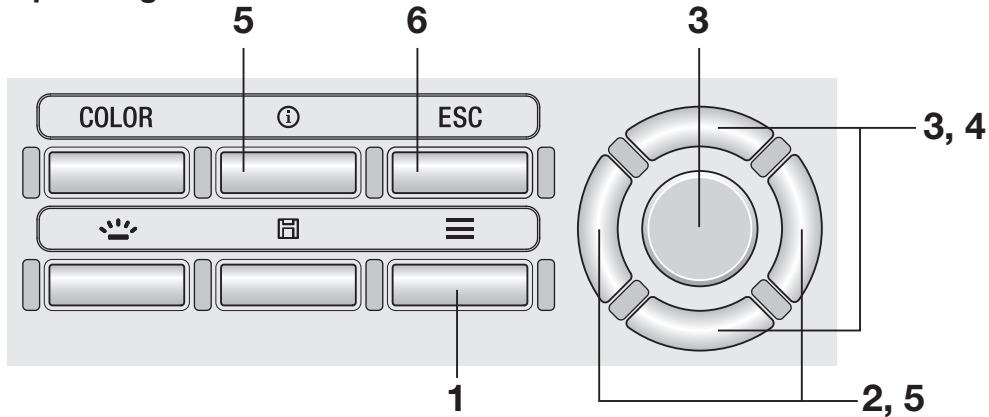

1. While the measurement screen is displayed, press the **MENU** key.

The **setting screen** is displayed on the LCD screen.

2. Press the **RIGHT** key or **LEFT** key to display the [Meas. Result] screen.

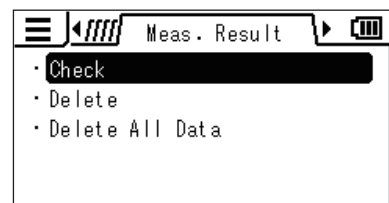

3. Press the **UP** key or **DOWN** key to select [Check] and then press the **ENTER** key.

4. The list of measurement results is displayed. Press the **UP** key or **DOWN** key to select the item you want to check.

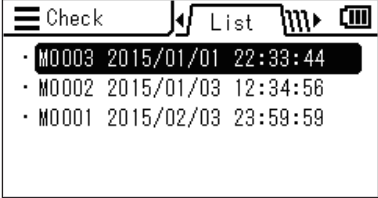

The screenshot shows a menu titled 'Check' with a 'List' option selected. Below the menu, a list of three items is displayed, each with a measurement ID, date, and time. The first item, 'M0003', is highlighted.

Item	Date	Time
M0003	2015/01/01	22:33:44
M0002	2015/01/03	12:34:56
M0001	2015/02/03	23:59:59

5. Press the **ENTER** key or **RIGHT** key.

The details of the item are displayed.
You can check the measurement condition, target, user calibration value, etc. by pressing the **INFO** key.

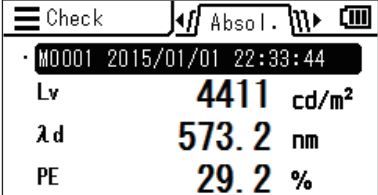

The screenshot shows a menu titled 'Check' with 'Absol.' selected. Below the menu, the details for item 'M0001' are displayed, including the date and time, and three parameters: Lv (4411 cd/m²), λd (573.2 nm), and PE (29.2 %).

Item	Date	Time
M0001	2015/01/01	22:33:44
Lv	4411	cd/m ²
λd	573.2	nm
PE	29.2	%

6. Press the **ESC** key twice.

The **measurement screen** is displayed on the LCD screen.

Deleting Stored Data

[Meas. Result]/[Target]/
[User Calibr.] - [Delete]

You can delete the stored measured values by following the procedure below.

Operating Procedure

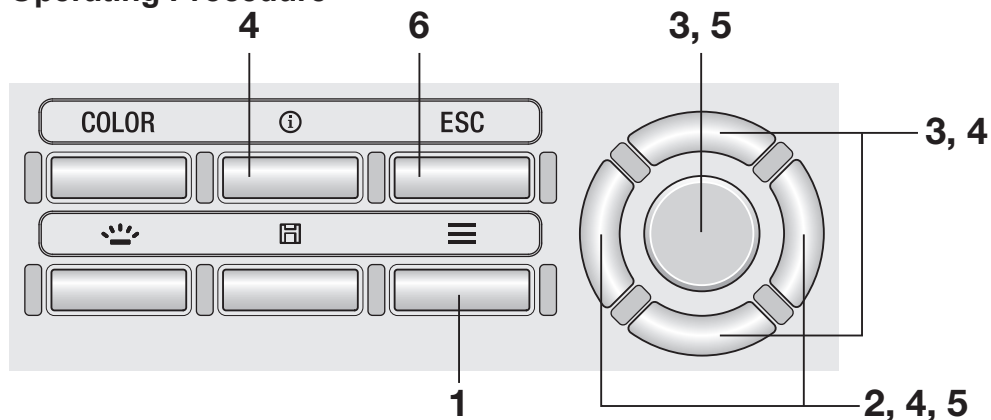

1. While the measurement screen is displayed, press the **[MENU]** key.

The **setting screen** is displayed on the LCD screen.

2. Press the **[RIGHT]** key or **[LEFT]** key to display the [Meas. Result], [Target] or [User Calibr.] screen.

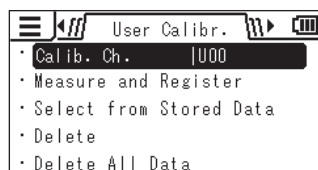
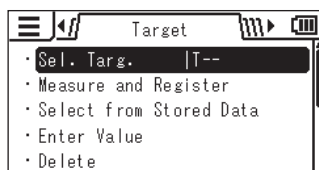
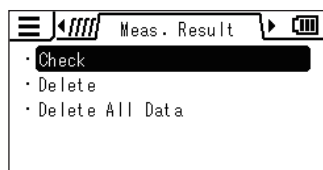

3. Press the **[UP]** key or **[DOWN]** key to select [Delete] and then press the **[ENTER]** key.

- 4.** The list of stored values is displayed. Press the **[UP]** key or **[DOWN]** key to select the item you want to delete.

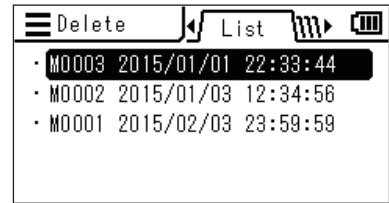

You can see the details of the selected item by pressing the **[RIGHT]** key.

You can check the measurement condition, target, user calibration value, etc. by pressing the **[INFO]** key.

When no data has been stored, "Measurement data not found." is displayed. When no target or user calibration data is stored it is displayed as "- - -".

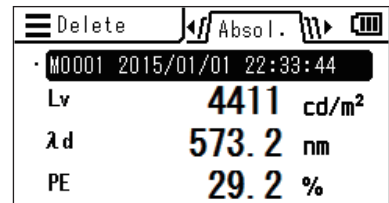

- 5.** When you press the **[ENTER]** key, a confirmation message is displayed. Press the **[RIGHT]** key or **[LEFT]** key to select **[Yes]** or **[No]** and press the **[ENTER]** key to confirm the action.

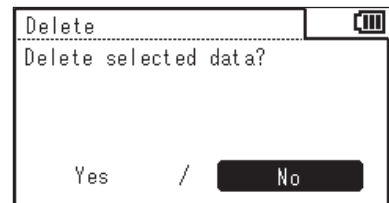

- 6.** Press the **[ESC]** key twice.

The **measurement screen** is displayed on the LCD screen.

Deleting All Stored Data

[Meas. Result]/[Target]/
[User Calibr.] - [Delete All Data]

You can delete all of the stored measured values by following the procedure below.
(This function is intended for deleting the values stored for [Meas. Result], [Target] or [User Calibr.])

Operating Procedure

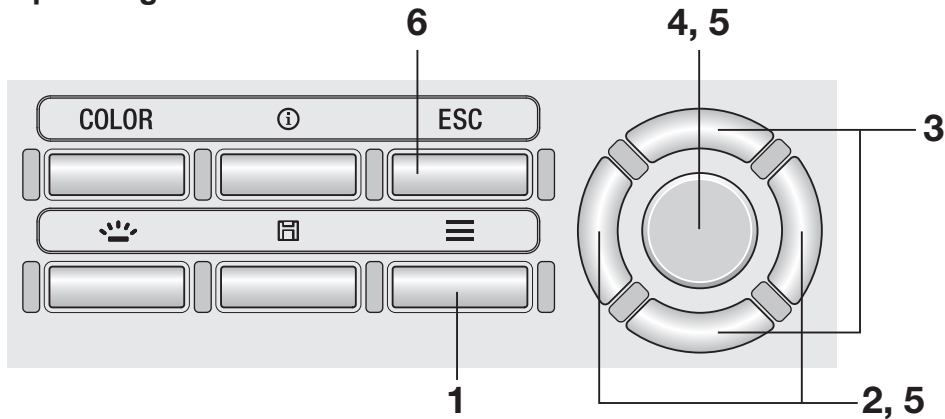

1. While the measurement screen is displayed, press the **MENU** key.

The **setting screen** is displayed on the LCD screen.

2. Press the **RIGHT** key or **LEFT** key to display the [Meas. Result], [Target] or [User Calibr.] screen.

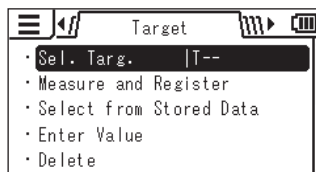
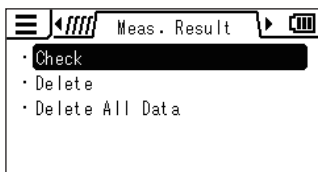

3. Press the **UP** key or **DOWN** key to select [Delete All Data].

4. Press the **ENTER key.**

The screen for selecting whether to delete all data or not is displayed.

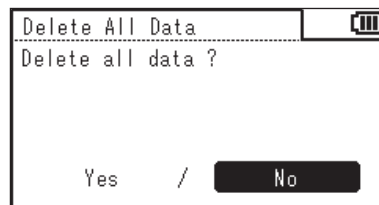

5. Press the **RIGHT key or **LEFT** key to select [Yes] or [No] and press the **ENTER** key to confirm the action.**

6. Press the **ESC key.**

The **measurement screen** is displayed on the LCD screen.

Communication

Connection to a PC

This instrument is capable of interactive communication with a PC. For communication with a PC, use the supplied USB cable (2 m) T-A15.

Although the USB cable can be connected/disconnected while the instrument is turned ON, you need to turn OFF the instrument before the connection in the procedure below.

Operating Procedure

- 1. Set the power switch to OFF (○ side).**
- 2. Slide the connector protection cover and connect the USB cable to the USB connection terminal.**
- 3. Check that the cable has been connected securely and completely.**
- 4. Set the power switch to ON (| side) and the  symbol is displayed at the upper right corner of the LCD screen to indicate that the USB connection with a PC has been established.**

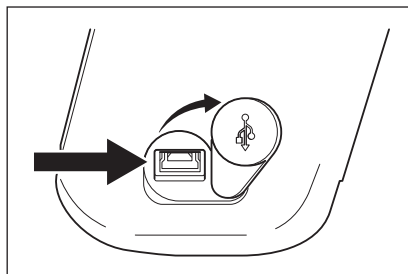
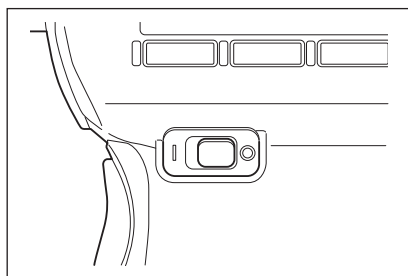

The communication interface of the instrument conforms to USB 2.0.

When disconnecting the USB cable, be sure to hold the plug of the cable. Do not pull the cord to disconnect it.

Check the orientation of the USB cable connector according to the shape of the connector port before insertion.

When the PC has several USB ports, you can use any port. Note, however, that when any USB device other than the CS/LS-150/160 is used simultaneously, the instrument may not operate properly.

Remote Mode

To control the instrument from a PC, use the data management software CS-S20. For the specifications and operation of CS-S20, refer to the instruction manual of CS-S20.

When the instrument is connected to a PC and CS-S20 is active on the PC, the instrument enters remote mode automatically.

While the instrument is controlled with a PC, "**REMOTE**" is displayed at the bottom of the LCD screen. (Refer to page 16.)

While this message is displayed, the key operation on the instrument is disabled except for the following case:

- There is a measurement mode that performs measurement when the Measuring button on the instrument is pressed and then sends the measured value to the PC.

If you want to control the instrument with a PC using your own program, you can download the communication specifications and other information from KONICA MINOLTA web site at:

<http://www.konicaminolta.com/instruments/download/software/>

(The URL above is subject to change without prior notice.)

(If you cannot find relevant pages, search the site with keywords "CS" and "download".)

Explanation and Information

Light-Receiving Element (Sensor)

The CS-150/160 is a high-accuracy tristimulus luminance color meter using three sensor outputs (XYZ = Red, green and blue) of the spectral responsivity corresponding to human eye sensitivity (CIE1931 color matching function).

It uses this spectral responsivity to measure an object, calculates the obtained tristimulus values (X, Y and Z) to convert them into $L_v x y$, $L_v u'v'$, $L_v T_{cp} duv$, dominant wavelength, and excitation purity, and display the result as a measured value.

The chromaticity coordinates (x, y) using $L_v x y$ (CIE 1931 color space) can be obtained by the following equations:

$$x = \frac{X}{X + Y + Z}, \quad y = \frac{Y}{X + Y + Z} \quad \text{where X, Y and Z are tristimulus values.}$$

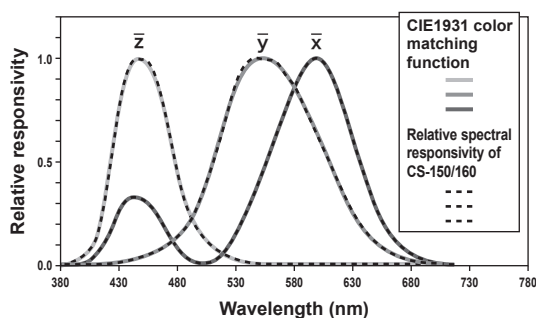

CIE1931 color matching function and spectral response of CS-150/160

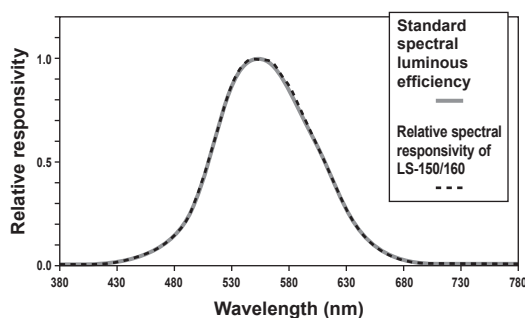

Standard spectral luminous efficiency and spectral response of LS-150/160

The LS-150/160 is a high-accuracy luminance meter using a sensor output of the standard spectral luminous efficiency corresponding to human eye sensitivity.

JIS C 1609-1:2006 specifies the evaluation of the spectral responsivity of a luminance meter as follows based on the deviation "f₁'" from the standard spectral luminous efficiency V(λ) when the instrument is calibrated with a standard light source with spectral distribution of 2856K black body radiation.

Classification	General Precision Class	General Class AA	General Class A
f ₁ '	3	6	9

The relative spectral responsivity of the LS-150/160 is equivalent to General Class AA (JIS C 1609-1:2006) and conforms to Class B of DIN 5032-7. The value f₁' is obtained by the following equation:

$$f_1' = \frac{\int_{\lambda_1}^{\lambda_2} |S'(\lambda)_{rel} - V(\lambda)| d\lambda}{\int_{\lambda_1}^{\lambda_2} V(\lambda) d\lambda} \times 100(\%)$$

The value S'(λ)_{rel} is expressed by the following equation:

$$S'(\lambda)_{rel} = \frac{\int_{\lambda_1}^{\lambda_2} P(\lambda)_A V(\lambda) d\lambda}{\int_{\lambda_1}^{\lambda_2} P(\lambda)_A S(\lambda)_{rel} d\lambda} \cdot S(\lambda)_{rel}$$

- P(λ)_A: Relative spectral distribution of standard illuminant A
- S(λ)_{rel}: Relative spectral responsivity of the illuminance meter
- V(λ): Standard spectral luminous efficiency
- dλ: Measurement wavelength interval (10 nm)
- λ₁: Lower limit of visible wavelength range
- λ₂: Upper limit of visible wavelength range

L_v T_{cp} duv Color Space

When this instrument is set to display the color mode L_v T_{cp} duv, the following values can be measured.

- L_v : Luminance
- T_{cp} : Correlated color temperature
- duv : Color difference from black body locus

The L_v T_{cp} duv color mode expresses luminance with L_v and color with T_{cp} and duv.

< Relation between correlated color temperature T_{cp} and color difference from black body locus duv >

Color temperature refers to the temperature of a black body (perfect radiator) which has equal chromaticity coordinates to a certain light. Consequently, color temperature can be used to represent colors only on black body locus.

Correlated color temperature, slightly wider interpretation of color temperature, is very useful to eliminate this problem. Here, correlated color temperature covers colors which are slightly outside the range of black body locus.

If a certain color is positioned on an isothermperature line, the intersection point of the isothermperature line and black body locus is indicated as the correlated color temperature for the color. An isothermperature line means a line on the chromaticity coordinate system which is a set of colors visually close to the color temperature on the black body locus. However, since all colors on one isothermperature line are represented with the same correlated color temperature, it is not possible to describe colors only with correlated color temperature. To solve the problem, duv, or deviation of correlated color temperature T_{cp} from the black body locus, is used.

If duv exists above the black body locus, it is represented with "+", and below, with "-".

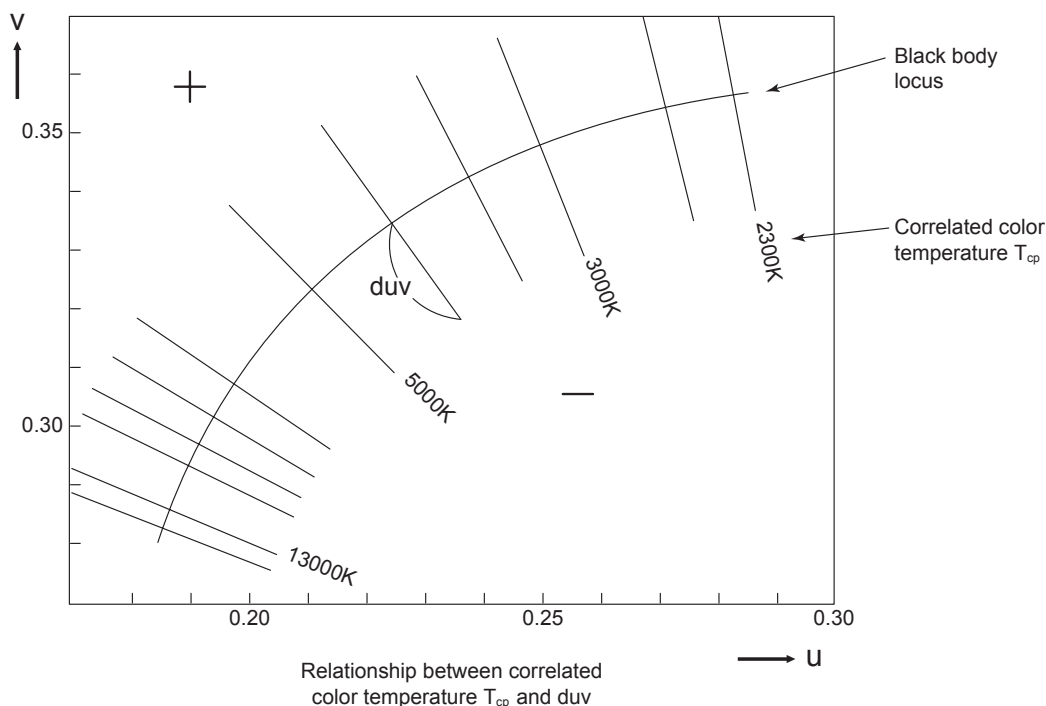

Dominant Wavelength/Excitation Purity

In the x, y chromaticity diagram shown below, the curve VS_cSR is the spectrum locus, and point N is the white point.

Colors located in the region enclosed by the spectrum locus and the straight lines VN and NR are referred to as spectral colors; and colors located in the triangle NVR with the white point N at the apex and the purple boundary VR as the base are referred to as non-spectral colors.

< Dominant wavelength and excitation purity (spectral colors) >

When the chromaticity point obtained by measurement is C, the wavelength corresponding to the intersection point S of the extension of NC with the spectrum locus (curve VS_cSR) is referred to as a dominant wavelength and is indicated by the symbol λ_d .

The ratio of the lengths of the straight lines NC and NS is referred to as the excitation purity of color excitation C and indicated by the symbol p_e .

< Complementary wavelength (non-spectral colors) >

When the chromaticity point obtained by measurement is C', the extension of NC' toward C' does not intersect with the spectrum locus but with the purple boundary. In this case, the wavelength corresponding to the intersection point S_c of the extension of NC' toward N with the spectrum locus is referred to as a complementary wavelength and is indicated by the symbol λ_c . This instrument also indicates it with the symbol λ_d with a minus sign.

When the intersection point of the extension of the line NC' with the line VR (purple boundary) is designated by S', the ratio of the lengths of NC' to NS' is referred to as excitation purity of color excitation C' and is indicated by the symbol p'_v .

The following equations are formulated where (x_n, y_n) is the chromaticity coordinates of point N, (x_c, y_c) is the chromaticity coordinates of point C, (x_λ, y_λ) is the chromaticity coordinates of point S, $(x_{c'}, y_{c'})$ is the chromaticity coordinates of point C', and (x_p, y_p) is the chromaticity coordinates of point P:

Excitation purity (spectral colors)

$$p_e = \frac{x_c - x_n}{x_\lambda - x_n} = \frac{y_c - y_n}{y_\lambda - y_n}$$

Excitation purity (non-spectral colors)

$$p'_v = \frac{x_{c'} - x_n}{x_p - x_n} = \frac{y_{c'} - y_n}{y_p - y_n}$$

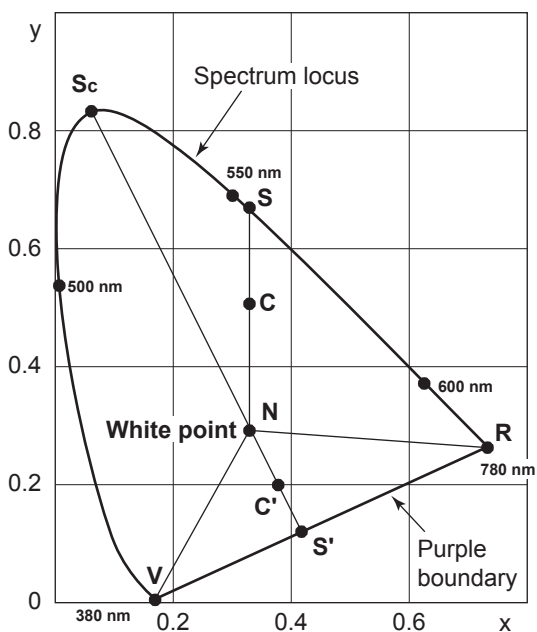

Dominant wavelength on chromaticity diagram

Object Color Measurement

This implement is capable of simplified object color measurement through the use of the user calibration function.

- Ensure that the white calibration plate (optional accessory) and the object to be measured are set in the same position and angle. If the illumination settings and measurement conditions are different between the white calibration plate and object to be measured, the measurement data is affected, resulting in incorrect measurement data.
- During the measurement, use a constant-voltage power supply for the illumination light source to ensure conditions are as stable as possible.

Setup for Object Color Measurement

1. Prepare one or more illumination light sources such as tungsten lamps, and set the white calibration plate as shown in the figure on the right.

- Set up the instrument so that it faces the white calibration plate perpendicularly.
- Set up the illumination light sources at a 45° angle.

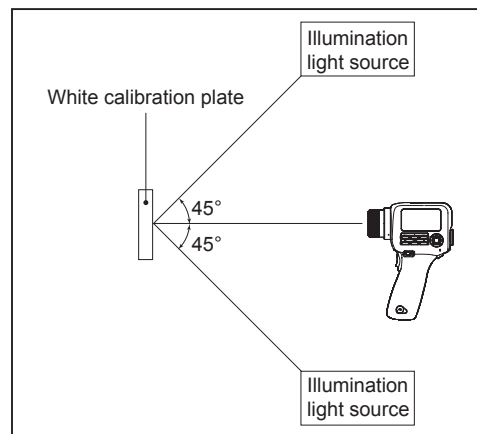

White Calibration

2. Perform the user calibration.

- ◆ For details, refer to page 65.

Measurement

3. Set the object to be measured at the same position and angle as the white calibration plate.

4. Measure the object.

Dimensions

(Unit: mm)

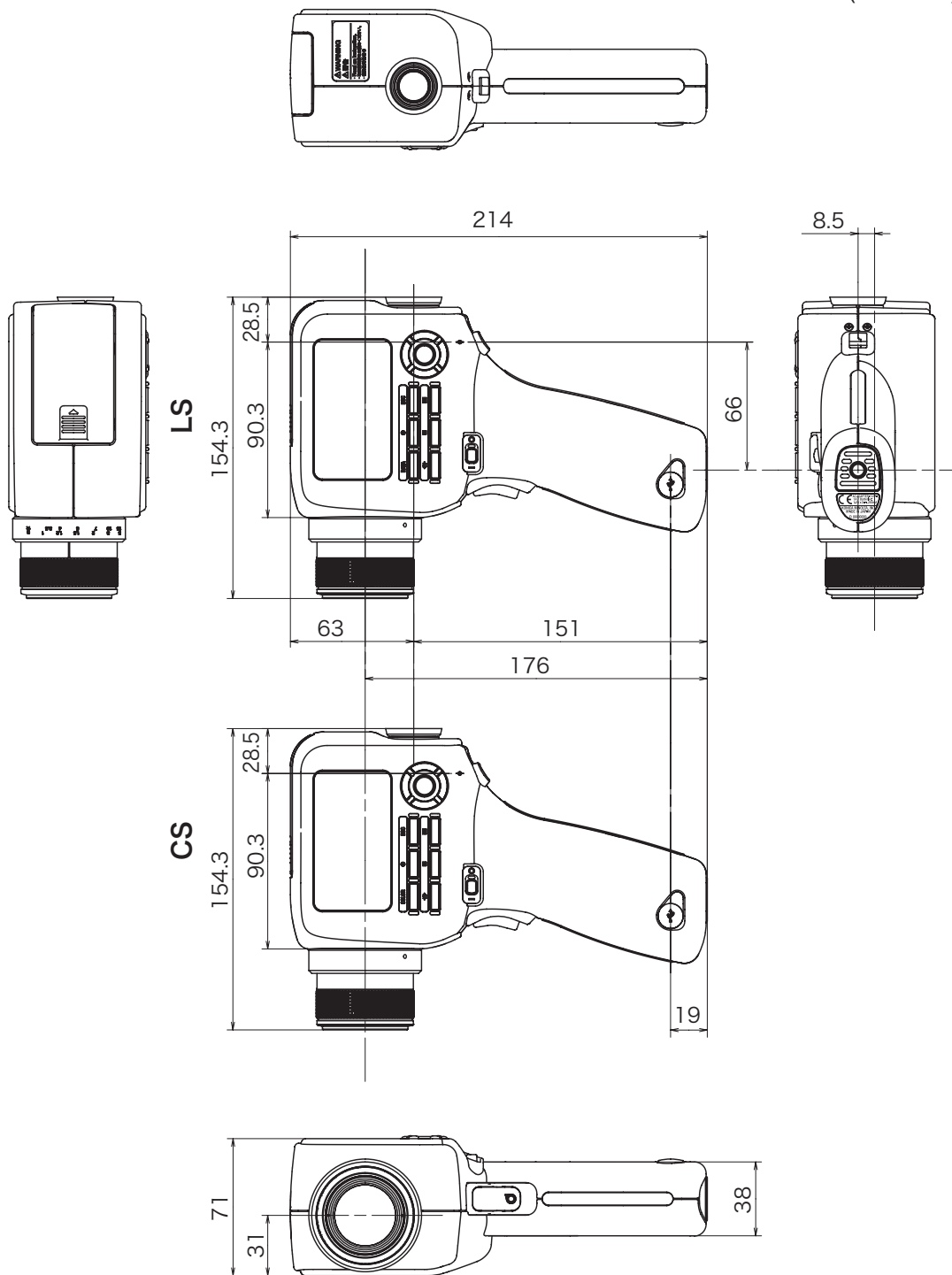

Error Messages

When the instrument does not operate properly as expected, it displays an error message on the LCD screen. The following table shows possible error messages, their meaning (cause), and countermeasures.

	Error message	Meaning (cause)	Countermeasure
1	Replace the battery.	The battery voltage is low.	<ul style="list-style-type: none"> Set the power switch to OFF (○ side) and replace the batteries with new ones or use the AC adapter.
2	Input value outside range.	The value you entered is out of the available range.	<ul style="list-style-type: none"> Enter a correct value. Be sure to enter a value that satisfies all the conditions of the value input rule. * Value input rule (Refer to page 70.)
3	Specify the date and time.	The instrument is started for the first time and the date and time have not been set.	<ul style="list-style-type: none"> Set correct date and time.
4	Memory full.	You attempted to save more than 1,000 measurement results.	<ul style="list-style-type: none"> Follow the guidance and overwrite the data or delete unnecessary measurement results.
5	Measurement data not found.	You attempted to check the measurement result or perform target setting or user calibration when there is no measurement data/ stored data in the instrument.	<ul style="list-style-type: none"> Perform measurement or select measurement data and then try the setting again.
6	Target data does not exist.	You attempted to set a target when there is no measurement data/stored data in the instrument.	<ul style="list-style-type: none"> Perform measurement or select measurement data and then try the setting again.
7	Backup battery has run out.	The backup battery voltage dropped, resulting in the corruption of setting data.	<ul style="list-style-type: none"> Charge the backup battery. The battery is fully charged in about 20 hours. When the battery is fully charged, configure the setting of the instrument again. If the problem persists, contact a KONICA MINOLTA-authorized service facility.

	Error message	Meaning (cause)	Countermeasure
8	Initializing memory.	Memory data corruption	<ul style="list-style-type: none"> • Press the ENTER key to conduct data initialization. • When "Memory Error" is displayed after the data initialization, contact a KONICA MINOLTA-authorized service facility.
9	Memory Error	Memory data corruption Hardware breakdown	<ul style="list-style-type: none"> • Contact a KONICA MINOLTA-authorized service facility.
10	Service is required.	Hardware breakdown	<ul style="list-style-type: none"> • Contact a KONICA MINOLTA-authorized service facility.

Checking for Malfunction

In the event that something goes wrong with the instrument, carry out the measures below. If the problem persists, a breakdown of the instrument may have occurred. Contact the nearest KONICA MINOLTA-authorized service facility. When contacting us, please tell us the malfunction No. and the version of your instrument. For the procedure to check the version of the instrument, refer to page 62.

Malfunction No.	Condition	Cause	Action	Reference page
1	The instrument is turned on but the LCD is blank.	Is the AC adapter connected to an AC outlet?	Connect the AC adapter.	22
		Is the AC adapter connected to the instrument?	Connect the AC adapter.	22
		Is a proper AC adapter connected?	Only use the optional AC adapter specified by KONICA MINOLTA (AC-A305J/L/M).	9
		Is the AC voltage within the range of the rating?	Use the instrument with a voltage within the range of nominal voltage $\pm 10\%$.	9
		Are the batteries loaded?	Load the batteries.	21
		Is the battery voltage low?	Replace the batteries with new ones. Or, connect the AC adapter.	21
2	I looked into the viewfinder but the field is too dark to see anything.	Is the lens cap still on the objective lens?	Remove the lens cap.	-
		Is the eyepiece ND filter attached to the viewfinder?	Use the eyepiece ND filter only when measuring a bright object.	-
3	Key operation is not accepted.	Is the instrument set in remote mode?	Press the [ESC] key to cancel remote mode.	95
		Is there any possibility that a key that does not work was pressed?	Press a correct key.	-
4	When I enter a calibration value/target, the value displayed after the setting is different from the entered value.		The value might be different by 1 digit due to calculation error.	108

Malfunction No.	Condition	Cause	Action	Reference page
5	The measured value flashes.	Is the value out of the guaranteed performance range?	The measured value flashes when it goes out of the guaranteed performance range.	108 109
		Is the measured value converted to large due to the user calibration?	The value flashes when the luminance exceeds the possible display range of the instrument.	
6	The measured value is displayed as "-----".	Does any data exist?	This display indicates that there is no data for the measured value, stored data, calibration value, or target.	-
		Is the color space set to color temperature?	This display indicates that the instrument cannot convert color temperature to display a value. The possible display range is as follows: $1563 \leq T_{cp} \leq 99990$ (K) $ duv < 0.1$	36
		Has a target been set for color difference measurement?	This display is shown as the color difference when a target has not set.	71
7	The measured value fluctuates.	Is the measured object stable?	Measure the object while it is stable.	-
		Does the object have low luminosity?	The measurement of low-luminosity objects may results in poor repeatability for x,y.	28
		If your object is a display unit, is the measurement synchronization frequency set properly?	Set an appropriate measurement synchronization frequency and try the measurement again.	30
		Does the ambient temperature/humidity change greatly?	Perform measurement in an environment where temperature/humidity does not change.	3
8	The displayed measured values are incorrect.	Is the objective lens clean?	Wipe off dirt with a soft clean dry cloth or lens cleaning paper.	4
		Did you perform user calibration correctly?	Perform user calibration again.	66
		Did you use a proper calibration channel?	Select a calibration channel set with a light source with the luminance and chromaticity close to the object to be measured.	80
		Is a close-up lens attached?	Select the lens type setting according to the lens attached.	42

Malfunction No.	Condition	Cause	Action	Reference page
9	The measurement stops in the middle of the process and does not continue for the specified measurement time.	Is the measured object stable?	When the amount of light from the measured object is not stable, the instrument may stop measurement and try it again to ensure the optimum range. Measure the object while it is stable.	-
		Is the luminosity of the measured object significantly different from the previous measurement?	When the luminosity of the measured object differs greatly from the previous measurement, the instrument may stop measurement and try it again to ensure the optimum range.	-
10	During USB communication: Data output from the instrument cannot be retrieved by the PC. Commands or data cannot be input from the PC to the instrument.	Is the USB cable connected securely?	Ensure secure connection between the instrument and PC.	94
		Is remote mode active?	Send the connect command from the PC to the instrument to set the instrument to remote mode. Use the data management software CS-S20.	95
		Is the program correct?	Check the program by referring to the sample program. Or, use the data management software CS-S20.	-
11	The measured data and other settings are cleared quickly.	Is the battery charge low because the instrument was used immediately after purchase or was not used for a long time?	Leave the power supply connected to charge the backup battery. The battery is fully charged in about 20 hours. The service life of the backup battery is about ten years of normal use. If, however, the memory is cleared quickly even after full charging, the battery must be replaced. For replacement, contact a KONICA MINOLTA-authorized service facility.	4
12	The same error message is displayed repeatedly.	Check the action for the error message.	If the problem persists, contact a KONICA MINOLTA-authorized service facility.	103

Specifications

Model name	CS-150	CS-160
Type	Chroma Meter	
Measuring angle	1°	1/3°
Optical system	SLR viewing system, f = 85 mm F2.8	
Angle of view	9° (visibility adjustment possible)	
Relative spectral responsivity	Close to CIE 1931 color matching function ($\bar{x}_\lambda, \bar{y}_\lambda, \bar{z}_\lambda$)	
Minimum measuring area (diameter)	14.4 mm 1.3 mm (when the close-up lens is used)	4.5 mm 0.4 mm (when the close-up lens is used)
Shortest measuring distance (From the measuring distance reference)	1,012 mm 213 mm (when the close-up lens is used)	
Color space	(Absolute value) $L_v, x, y (Y, x, y); L_v, u', v'; L_v, T_{cp}, duv; XYZ; L_v, \lambda_d, P_e$	
Measurement mode	(Luminance) Instantaneous value, maximum/minimum value, luminance difference (Δ)/luminance ratio (%) (Chromaticity) Instantaneous value, chromaticity difference (Δ)	
Measurement time	Auto: 0.7 to 4.3 seconds Manual: 0.7 to 7.1 seconds	
Luminance unit	cd/m ² or fL	
Luminance range	0.01 to 999,900 cd/m ²	0.1 to 9,999,000 cd/m ²
Accuracy*1	(Luminance) $\pm 2\% \pm 1$ digit (Chromaticity) ± 0.004 (5 cd/m ² or more)	(Luminance) $\pm 2\% \pm 1$ digit (Chromaticity) ± 0.004 (50 cd/m ² or more)
Repeatability*1	(Luminance) 0.2% + 1 digit (Chromaticity) 0.001 (10 cd/m ² or more) (Chromaticity) 0.002 (5 cd/m ² or more)	(Luminance) 0.2% + 1 digit (Chromaticity) 0.001 (100 cd/m ² or more) (Chromaticity) 0.002 (50 cd/m ² or more)
Calibration standard	Konica Minolta standard/user-specified standard switchable	
No. of user calibration channels	10 channels	
Amt. of storable data	1,000 items	
External display (No. of significant digits)	(Luminance) 4 digits (Chromaticity) 4 digits	
Internal display (No. of significant digits)	(Luminance) 4 digits	
Interface	USB 2.0	
Power supply	Two AA batteries, USB bus power, or AC adapter (Option)	
Current consumption	When viewfinder display is lit: 70 mA average	
Operation temperature/ humidity range	0 to 40°C, relative humidity of 85% or less (at 35°C)	
Storage temperature/ humidity range	0 to 45°C, relative humidity of 85% or less (at 35°C)	
Dimensions	71 x 214 x 154 mm	
Weight	850 g (excluding batteries)	
Standard accessories	Lens cap Eyepiece ND filter Eyepiece cap AA battery x 2 Case CS-A12 Wrist strap CS-A13 USB cable T-A15 Data management software CS-S20	
Optional accessories	Close-up lens No. 153/135/122/110 CCD camera adapter CS-A14 Illuminance adapter CS-A15 White calibration plate (for 45-0) CS-A20 AC adapter AC-A305J/L/M	

*1 "A" light source, reference distance, measurement time: AUTO

Model name	LS-150	LS-160
Type	Luminance Meter	
Measuring angle	1°	1/3°
Optical system	SLR viewing system, f = 85 mm F2.8	
Angle of view	9° (visibility adjustment possible)	
Relative spectral responsivity	Close to standard spectral luminous efficiency (V(λ))	
Applicable standard	DIN 5032-7 Class B compliant	(N/A)
Minimum measuring area (diameter)	14.4 mm 1.3 mm (when the close-up lens is used)	4.5 mm 0.4 mm (when the close-up lens is used)
Shortest measuring distance (From the measuring distance reference)	1,012 mm 213 mm (when the close-up lens is used)	
Measurement mode	(Luminance) Instantaneous value, maximum/minimum value, luminance difference (Δ)/luminance ratio (%)	
Measurement time	AUTO: 0.7 to 4.3 seconds Manual: 0.7 to 7.1 seconds	
Luminance unit	cd/m ² or fL	
Luminance range	0.001 to 999,900 cd/m ²	0.01 to 9,999,000 cd/m ²
Accuracy*1	(Luminance) ±2% ± 2 digits (1 cd/m ² or less) ±2% ± 1 digit (1 cd/m ² or more)	(Luminance) ±2% ± 2 digits (10 cd/m ² or less) ±2% ± 1 digit (10 cd/m ² or more)
Repeatability*1	(Luminance) 0.2% + 1 digit	(Luminance) 0.2% + 1 digit
Calibration standard	Konica Minolta standard/user-specified standard switchable	
No. of user calibration channels	10 channels	
Amt. of storable data	1,000 items	
External display (No. of significant digits)	(Luminance) 4 digits	
Internal display (No. of significant digits)	(Luminance) 4 digits	
Interface	USB 2.0	
Power supply	Two AA batteries, USB bus power, or AC adapter (Option)	
Current consumption	When viewfinder display is lit: 70 mA average	
Operation temperature/humidity range	0 to 40°C, relative humidity of 85% or less (at 35°C)	
Storage temperature/humidity range	0 to 45°C, relative humidity of 85% or less (at 35°C)	
Dimensions	71 x 214 x 154 mm	
Weight	850 g (excluding batteries)	
Standard accessories	Lens cap Eyepiece ND filter Eyepiece cap AA battery x 2 Case CS-A12 Wrist strap CS-A13 USB cable T-A15 Data management software CS-S20	
Optional accessories	Close-up lens No. 153/135/122/110 CCD camera adapter CS-A14 Illuminance adapter CS-A15 AC adapter AC-A305J/L/M	

*1 "A" light source, reference distance, measurement time: AUTO

MEMO

< CAUTION >

KONICA MINOLTA WILL NOT BE LIABLE FOR ANY DAMAGES RESULTING FROM THE MISUSE, MISHANDLING, UNAUTHORIZED MODIFICATION, ETC. OF THIS PRODUCT, OR FOR ANY INDIRECT OR INCIDENTAL DAMAGES (INCLUDING BUT NOT LIMITED TO LOSS OF BUSINESS PROFITS, INTERRUPTION OF BUSINESS, ETC.) DUE TO THE USE OF OR INABILITY TO USE THIS PRODUCT.



KONICA MINOLTA