

Operators manual

Handheld Multi-Purpose Interface (HHMPI)



Copyright © Flight Data Systems 2014

This manual is property of Flight Data Systems. This manual contains information in which Flight Data Systems has a protected interest. This manual is a controlled document and as such is subject to amendment. It is in the interest of the user to register this manual with Flight Data Systems to ensure receipt of any amendments. The use, duplication, and/or disclosure, by persons receiving this manual may be subject to restrictions. No part of this document and/or data contained herein may be reproduced and/or used in any form without written permission from Flight Data Systems.

Contents

| | |
|--|-----------|
| Record of changes | 4 |
| List of figures | 4 |
| List of tables | 5 |
| 2.0 Introduction | 5 |
| 2.1 HHMPI models | 6 |
| 2.2 HHMPI equipment | 9 |
| 3.0 Getting started | 12 |
| 3.1 Terminology used in this manual | 12 |
| 3.2 Using the HHMPI | 13 |
| 3.2.1 Connecting the HHMPI to an FDR | 13 |
| 3.2.2 Powering and charging the HHMPI | 14 |
| 3.2.3 Charging the HHMPI with the docking cradle | 15 |
| 3.2.4 Turning on the HHMPI and self-test | 16 |
| 3.2.5 Reset operation | 16 |
| 3.3 Shortcuts | 17 |
| 3.4 Menu structure | 17 |
| 3.5 HHMPI configuration | 17 |
| 4.0 Operation | 19 |
| 4.1 Download file name | 19 |
| 4.2 Aircraft lists | 19 |
| 4.2.1 Loading aircraft details | 19 |
| 4.2.2 Creating an Aircraft List on a PC | 20 |
| 4.2.3 Transferring the Aircraft List to the HHMPI | 20 |
| 4.2.4 Creating the Aircraft List on the HHMPI | 21 |
| 4.2.5 Adding Entries to the HHMPI Aircraft File | 21 |
| 4.2.6 Deleting an aircraft from the Aircraft list on the HHMPI | 21 |
| 4.2.7 Saving the Aircraft list to the USB flash drive on the HHMPI | 22 |
| 4.2.8 Deleting all aircraft from the Aircraft list on the HHMPI | 22 |
| 4.2.9 Prompt for Tail No. | 22 |
| 4.3 Downloading flight data | 23 |
| 4.3.1 Downloading recorded data from the FDR to a USB flash drive | 23 |
| 2.3 Accessories | 10 |
| 2.4 Specifications | 10 |
| 3.5.1 Clock Settings | 17 |
| 3.5.2 Display Settings | 17 |
| 3.5.3 Memory Settings | 17 |
| 3.5.4 Network Settings | 18 |
| 3.5.5 Aircraft Settings | 18 |
| 3.5.6 Security Settings | 18 |
| 3.5.7 Live Data Settings | 18 |
| 3.5.8 Shortcut Keys | 18 |
| 3.5.9 Settings Profile | 18 |
| 3.6 Information | 19 |
| 4.3.2 Decompressing CVR data at the aircraft | 24 |
| 4.3.3 Decompressing CVR away from the aircraft | 25 |
| 4.3.4 Using the CVR rack adapter | 26 |
| 4.4 Viewing live flight data | 26 |
| 4.4.1 Live Data View Options | 28 |
| 4.4.2 Adjusting ARINC 717 settings | 28 |
| 4.4.3 Changing the display format | 28 |
| 4.5 Viewing live flight data in engineering units | 29 |
| 4.5.1 Assigning an Aircraft Definition file to an aircraft | 30 |
| 4.5.2 Viewing Live Flight Data | 30 |
| 4.6 File transfer operations | 32 |
| 4.6.1 File transfer between HHMPI storage locations | 32 |
| 4.6.2 Other storage operations | 33 |
| 4.6.3 File transfer PC to HHMPI | 33 |
| 4.7 Network operations | 33 |
| 4.7.1 DHCP network settings | 33 |
| 5.0 Configuring an FTP connection | 34 |

| | | | |
|--|-----------|---|----|
| 5.1 Adding a new FTP server from the HHMPI. | 34 | face | 39 |
| 5.2 Configuring an existing FTP server from the HHMPI | 35 | 5.4.2 Backing up the HHMPI configuration | 40 |
| 5.3 Testing an FTP server from the HHMPI. | 37 | 5.4.3 Restoring backup files via the web interface | 41 |
| 5.4 Setting up an FTP connection from the web interface. | 37 | 5.4.4 Administration settings. | 41 |
| 5.4.1 Changing the HHMPI configuration via the web inter- | | 5.4.5 Logging out of the web interface. | 41 |
| 6.0 Wirelessly uploading files from the HHMPI to a server | 42 | | |
| 6.1 Setting up a wireless network connection | 42 | 6.1.3 Connecting to a wireless network. | 43 |
| 6.1.1 Required equipment and wireless network information | 42 | 6.1.4 Uploading files via FTP with a wireless network connec- | 44 |
| 6.1.2 Turning on wireless network support. | 42 | tion. | |
| 7.0 Troubleshooting | 44 | | |
| 8.0 FA2100, FA2200 and FA2300 Interface Supplement | 48 | | |
| 8.1 Download Operations | 48 | 8.8 Dump Fault Log. | 49 |
| 8.2 Recorder Operations | 48 | 8.9 Dump Debug Trace | 49 |
| 8.3 FDR Status | 49 | 8.10 Memory Marker | 49 |
| 8.4 CVR Status | 49 | 8.11 Audio Operations. | 50 |
| 8.5 FDR or CVR Fault Output. | 49 | 8.12 Live Data View. | 50 |
| 8.6 Clear Latched Fault. | 49 | 8.13 Menu Tree | 50 |
| 8.7 Clear Fault Log. | 49 | | |
| 9.0 SRVIVR Interface Supplement | 51 | | |
| 9.1 Download Operations | 51 | 9.4 Live Data View. | 53 |
| 9.2 Recorder Operations | 52 | 9.5 Menu Tree | 54 |
| 9.3 Audio Operations | 53 | | |
| 10.0 FA5000/FA5001 Interface Supplement | 55 | | |
| 10.1 Download Operations | 55 | 10.4 Audio Operations. | 57 |
| 10.2 Recorder Operations | 56 | 10.5 Live Data View. | 58 |
| 10.3 FDR Configuration | 57 | 10.6 Menu Tree | 58 |
| 11.0 SMITHS VADR Interface Supplement | 60 | | |
| 11.1 Select Aircraft | 60 | | |
| 11.2 Download Operations | 60 | | |
| 11.3 FDR Configuration | 60 | | |
| 11.4 Upload OFP to the HHMPI | 60 | | |

1.0 Record of changes

Table 1.0 Record of changes

| Issue | Date | Comments |
|---------|------------------|--|
| 4 | 24 June 2011 | New issue |
| 5 | 20 July 2011 | Added battery pack description Added PCMCIA card description Added appendices |
| 6 | 9 September 2011 | Added FTP setup Added wireless USB Added updated live data view Added troubleshooting |
| Issue B | 12 November 2013 | Added CVR decompression instructions Added CVR adapter instructions Added HHMPI cradle features Added aircraft settings |
| Issue C | 3 December 2013 | Updated references Added screen captures to upload VADAR Program MOD table update |
| Issue D | 22 May 2014 | Updated layout Added Engineering Units section |

List of figures

| | | |
|-------------|---|----|
| Figure 1.0 | HHMPI front view | 6 |
| Figure 2.0 | HHMPI top view | 7 |
| Figure 3.0 | HHMPI bottom view | 7 |
| Figure 4.0 | HHMPI Mod 1 top view | 8 |
| Figure 5.0 | HHMPI Mod 1 bottom view | 8 |
| Figure 6.0 | HHMPI kit | 9 |
| Figure 7.0 | Connecting the HHMPI to the FDR or CVR | 14 |
| Figure 8.0 | The Battery Status screen | 15 |
| Figure 9.0 | HHMPI power-on sequence | 16 |
| Figure 10.0 | Creating an Aircraft List in Notepad | 20 |
| Figure 11.0 | Adding aircraft to the Aircraft List on the HHMPI | 21 |
| Figure 12.0 | Configuring the prompt for tail number option | 23 |
| Figure 13.0 | Downloading progress bar | 24 |
| Figure 14.0 | Downloading and decompressing CVR data | 25 |
| Figure 15.0 | Decompressing Honeywell CVR file away from the aircraft | 26 |
| Figure 16.0 | Viewing live data | 27 |
| Figure 17.0 | ARINC 717 settings | 28 |
| Figure 18.0 | Multiple live data view | 29 |
| Figure 19.0 | Word offset adjust | 29 |
| Figure 20.0 | Selected tail number on the shortcut screen | 31 |
| Figure 21.0 | Changing from Raw Mode to EU Mode | 31 |
| Figure 22.0 | Accessing aircraft parameters alphabetically | 32 |
| Figure 23.0 | Four parameters populated with Engineering Units | 32 |
| Figure 24.0 | DHCP or manual IP configuration | 34 |
| Figure 25.0 | Setting up the FTP client | 35 |
| Figure 26.0 | FTP type menus | 36 |
| Figure 27.0 | Login, password, remote path and FTP test | 37 |

| | | |
|-------------|--|----|
| Figure 28.0 | Viewing the wired IP address | 38 |
| Figure 29.0 | Web interface login | 38 |
| Figure 30.0 | Web interface screen | 39 |
| Figure 31.0 | Device configuration screen | 40 |
| Figure 32.0 | Device configuration screen | 40 |
| Figure 33.0 | Device configuration screen | 41 |
| Figure 34.0 | Logout button | 42 |
| Figure 35.0 | Connecting to a wireless network. | 43 |
| Figure 36.0 | Configuring security settings like the encryption type and key | 44 |
| Figure 37.0 | FA2100 Recorder Operations - Dump Debug Trace | 49 |
| Figure 38.0 | CVR Live Audio volume control. | 50 |
| Figure 39.0 | SRVIVR Download Operations. | 52 |
| Figure 40.0 | SRVIVR Recorder Operations - Information | 53 |
| Figure 41.0 | SRVIVR Recorder Operations - Self Test | 53 |
| Figure 42.0 | FA5000/FA5001 Download Operations | 56 |
| Figure 43.0 | FA5000/FA5001 Recorder Operations - FDR Status | 57 |
| Figure 44.0 | FA5000/FA5001 Recorder Operations - Dump Log | 57 |
| Figure 45.0 | CVR Live Audio volume control. | 58 |
| Figure 46.0 | VADR information | 60 |
| Figure 47.0 | Uploading OFP to the VADR from the HHMPI | 61 |

List of tables

| | | |
|------------|--|----|
| Table 1.0 | Record of changes. | 4 |
| Table 2.0 | HHMPI models and description of modifications applied | 6 |
| Table 3.0 | HHMPI equipment list | 9 |
| Table 4.0 | Interface cables and software options | 10 |
| Table 5.0 | Specifications HHMPI Mod 5 (no battery) | 10 |
| Table 6.0 | Specifications HHMPI Mod 1 and 5 (battery) | 11 |
| Table 7.0 | Troubleshooting common issues with the HHMPI | 45 |
| Table 8.0 | File extensions of files downloaded from the FA2100 | 48 |
| Table 9.0 | Additional menu items for FA2100 CVFDR | 50 |
| Table 10.0 | File extensions of files downloaded from the SRVIVR | 52 |
| Table 11.0 | Additional menu items for SRVIVR CVFDR | 54 |
| Table 12.0 | Additional menu items for FA5000/FA5001 CVFDR | 58 |
| Table 13.0 | File extensions of files downloaded from the Smiths VADR | 60 |

2.0 Introduction

The Handheld Multi-Purpose Interface (HHMPI) is a portable instrument for downloading data from a Flight Data Recorder (FDR) and audio from a Cockpit Voice Recorder (CVR). It is connected to the recorder via an interface cable which identifies the attached recorder type. The downloaded data is stored in one of the following memory options: internal memory, USB flash drive, Compact Flash card, SD card, or optional PCMCIA card.

2.1 HHMPI models

Table 2.0 HHMPI models and description of modifications applied

| HHMPI modifications | Description |
|---------------------|--|
| Mod 1 | External battery with PCMCIA card slot |
| Mod 2 | Firmware enhancement FA2100 CVR software (ADF) |
| Mod 3 | VADR software interface implemented (ADF) |
| Mod 4 | MCR500 software interface implemented (ADF) |
| Mod 5 | Version 2 HHMPI |
| Mod 6 | Internal battery on HHMPI added |
| Mod 7 | Docking cradle |
| Mod 8 | Audio jack added for CVR capability (ADF) |
| Mod 9 | New revision firmware added (ADF) |
| Mod 10 | New revision firmware added (ADF) |

Figure 1.0 HHMPI front view

Legend

External devices connected:
recorder, external memory device,
Ethernet, USB flash drive

1.

User programmable shortcut keys
(4)

2.

OK button and cursor keys (4)

3.

Cancel / exit

4.



Figure 2.0 HHMPI top view

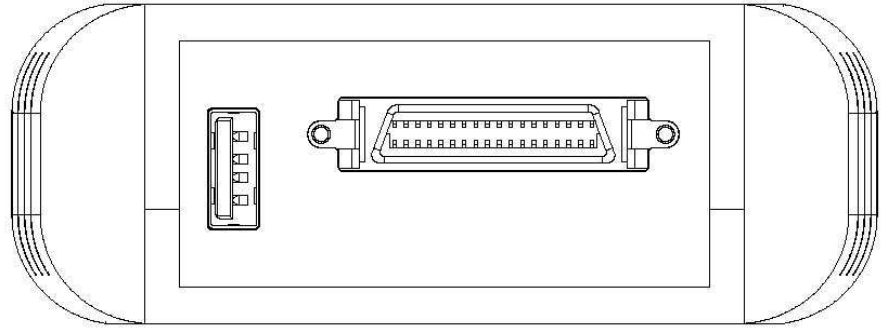

Figure 3.0 HHMPI bottom view

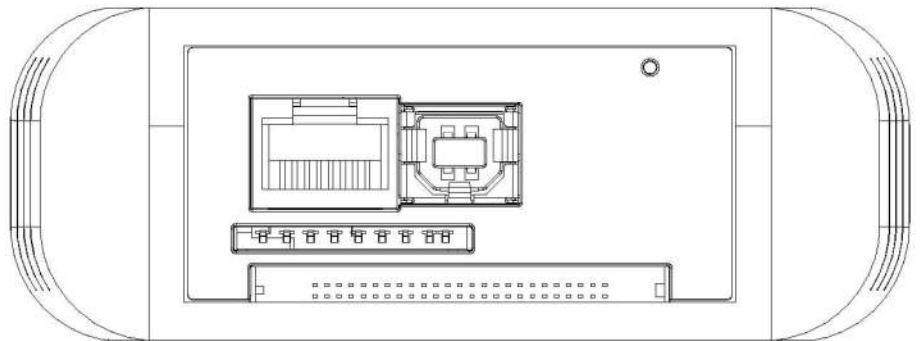

Figure 4.0 HHMPI Mod 1 top view

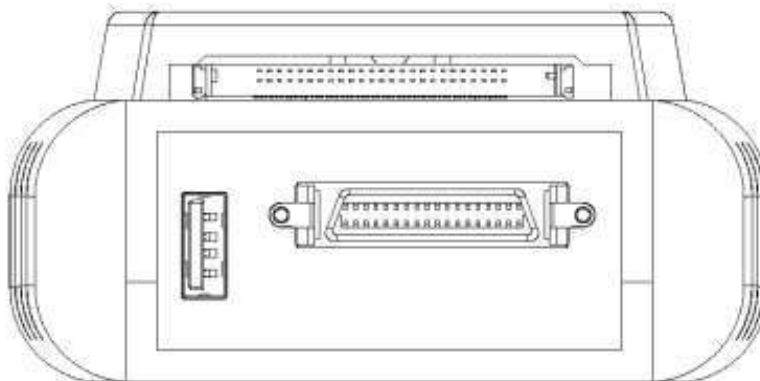

Figure 5.0 HHMPI Mod 1 bottom view

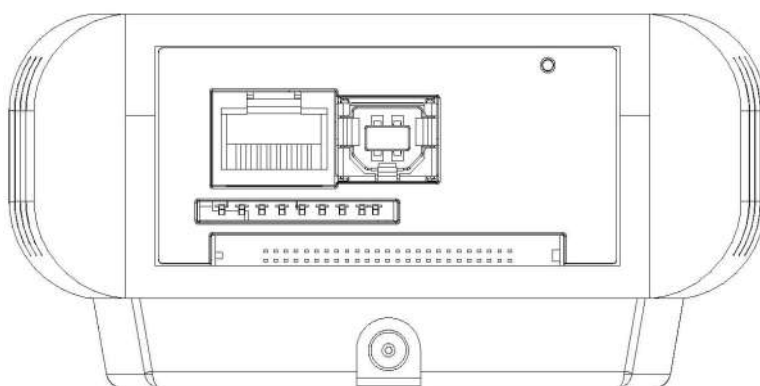

Figure 6.0 HHMPI kit



2.2 HHMPI equipment

Table 3.0 HHMPI equipment list

| Part number | Description | Applicable mod status |
|-------------|---|-----------------------|
| DF136 | Quick reference guide, HHMPI | All |
| FDS400-107 | Cable USB, HHMPI to PC | All |
| FDS400-301 | HHMPI | Mod 5 |
| FDS400-301 | HHMPI with internal battery | Mod 5, 6 |
| FDS400-301 | HHMPI with external battery and PCMCIA card | Mod 1, 5 |
| FDS400-302 | USB flash drive (2GB) | All |
| FDS400-303 | Compact flash card, HHMPI | Option - all |
| FDS400-304 | SD card, HHMPI | Option - all |
| FDS400-321 | Carry case, yellow | All except Mod 1 |
| FDS400-322 | Power adapter kit, global, charger for internal battery | Mod 6 |
| FDS400-334 | Carry case, black | Mod 1 |
| FDS400-373 | Docking cradle | Mod 7 |

2.3 Accessories

Table 4.0 Interface cables and software options

| Accessory part number | Description |
|-----------------------|---|
| FDS400-107 | Cable USB, HHMPI to PC |
| FDS400-201 | Interface cable, L-3 AR, F1000 |
| FDS400-202 | Interface cable, L-3 AR, FA2100 |
| FDS400-203 | Interface cable, HNY, SSFDR, (DC or Battery HHMPI only) |
| FDS400-204 | Interface cable, HNY, UFDR, SSDFDR |
| FDS400-208 | Interface cable, HNY, AR series |
| FDS400-209 | Interface cable, L-3 EDI, SRVIVR™ |
| FDS400-210 | Interface cable, HNY, Light weight |
| FDS400-212 | Interface cable, MCR500 |
| FDS400-215 | Interface cable, SSCVR, Rack adapter and aircraft |
| FDS400-216 | Interface cable, HYN, SSCVR, Bench download cable |
| FDS400-223 | Interface cable, L-3 AR, FA5000/FA5001 |
| FDS400-224 | Interface cable, UASC, CVFDR, CVR, FDR |
| FDS400-227 | Interface cable, HNY, DVDR |
| FDS400-232 | Interface cable, HNY, HFR5-D |
| FDS400-246 | Interface cable, HNY, AR CVR/Combi |
| FDS400-241 | Interface cable, L-3 Micro QAR |
| FDS400-257 | Interface cable adapter, MCR500 to SCR500 |
| FDS400-258 | Audio breakout fixture, MCR500 to SCR500 |
| FDS400-259 | Audio test fixture, SCR500 |
| FDS400-331 | Card reader, PCMCIA, option |
| FDS400-332 | Wireless interface, USB 802.11g, option |
| FDS400-379 | L-3 FA2100 CVR download and decompression software |
| FDS400-380 | HNY CVR download and decompression software |

2.4 Specifications

Table 5.0 Specifications HHMPI Mod 5 (no battery)

| Parameter | |
|--------------------------|--|
| Weight | HHMPI: 330 g HHMPI kit: 3 kg (see Figure 6.0, "HHMPI kit", on page 9) Shipping: 4 kg |
| Dimensions: L x W x H | HHMPI: 145 x 95 x 35 mm HHMPI kit: 365 x 270 x 135 mm |
| Power | USB or FDR/CVR interface cable |
| Environmental protection | IP-40 |
| Temperature | Operating: -20°C to +60°C |

Table 5.0 Specifications HHMPI Mod 5 (no battery)

| Parameter | |
|-------------------|--|
| Certification | FCC Part 15 Subpart B, July 2008 CE ANSI C63.4-2003 EN55022: 2006 (CISPR22: 2005, modified) AS/NZS CISPR22: 2006 (CISPR22: 2006) EN55024: 1998 Amendment 1: 2001 Amendment 2: 2003 CISPR24: 1997 MODIFIED Amendment 1: 2001 Amendment 2: 2002 |
| Data view | ARINC 717 for all recorders ARINC 429 standard ARINC 429 periodic Data Link Rate (DLR) |
| Data view formats | Binary Octal Decimal Hexadecimal |
| Memory supported | Internal SD card CF card USB flash drive |
| Communications | USB v2.0 to PC Ethernet RJ-45 to network Ethernet via recorder interface to recorder R2-422 via recorder interface to recorder Wireless 802.11g capability via optional USB key |

Table 6.0 Specifications HHMPI Mod 1 and 5 (battery)

| Parameter | |
|--------------------------|--|
| Weight | HHMPI: 495 g HHMPI kit: 3.2 kg see (Figure 6.0, "HHMPI kit", on page 9) Shipping: 4.2 kg |
| Dimensions: L x W x H | HHMPI: 145 x 95 x 46 mm HHMPI kit: 365 x 270 x 135 mm |
| Power | USB or FDR/CVR interface cable Internal Lithium Ion battery |
| Environmental protection | IP-40 |
| Temperature | Operating: 0°C to +60°C |
| Certification | FCC Part 15 Subpart B, July 2008 CE ANSI C63.4-2003 EN55022: 2006 (CISPR22: 2005, modified) AS/NZS CISPR22: 2006 (CISPR22: 2006) EN55024: 1998 Amendment 1: 2001 Amendment 2: 2003 CISPR24: 1997 MODIFIED Amendment 1: 2001 Amendment 2: 2002 |
| Data view | ARINC 717 for all recorders ARINC 429 standard ARINC 429 periodic Data Link Rate (DLR) |
| Data view formats | Binary Octal Decimal Hexadecimal |

Table 6.0 Specifications HHMPI Mod 1 and 5 (battery)

| Parameter | |
|------------------|---|
| Memory supported | Internal SD card CF card USB flash drive PCMCIA card (ATA flash type only) |
| Communications | USB v2.0 to PC Ethernet RJ-45 to network Ethernet via recorder interface to recorder R2-422 via recorder interface to recorder Wireless 802.11g capability via optional USB key |

3.0 Getting started

3.1 Terminology used in this manual

In this manual the hardware buttons on the HHMPI are referred to as the **left, right, up, down, OK, or cancel** buttons. See Figure 1.0, "HHMPI front view", on page 6 for the locations of these buttons on the HHMPI.

In this manual you may also see information of special importance in the form of tips and notes.

A *note* with the heading "Note" indicates neutral or positive information that emphasizes or supplements important points in this manual. For example:

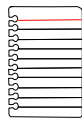

Note If the HHMPI prompts you for a network password at startup, your FTP network is already set up, and you can skip this section.

A *tip* is a type of note that helps you apply the techniques and procedures described in this manual. A tip may suggest an alternative method of completing a task—tips are not essential to the basic understanding of this manual. For example:



Tip You can also use these steps to copy an aircraft definition file.

An *important note* provides information that is essential to the completion of a task. You can disregard information in a note and still complete a task, but you should not disregard an important note. For example:



Important When powering up the HHMPI ensure that no external devices are connected.

A *caution* is a type of note that advises you that failure to take or avoid a specific action could result in damage or loss of data. For example:



Caution Before applying power, verify that the product is set to match the line voltage and the correct fuses are installed.

A *menu sequence* shows you how to open a series of menus. For example:

▼▲ **Main Menu > Device Configuration > Settings Profile > Save Aircraft > USB Flash Drive**

3.2 Using the HHMPI

To download data from a Flight Data Recorder (FDR) or Cockpit Voice Recorder (CVR), you need the following equipment:

- The HHMPI kit, see Figure 6.0, "HHMPI kit", on page 9.
- An interface cable for the specific recorder you want to download data from, see Table 4.0, "Interface cables and software options," on page 10.

3.2.1 Connecting the HHMPI to an FDR

To connect the HHMPI to a recorder use the interface cable for the specific recorder you want to download data from. Power is often supplied through the interface cable to the HHMPI from an aircraft powered recorder. In this configuration it is safe to connect or disconnect the HHMPI. See Figure 7.0, "Connecting the HHMPI to the FDR or CVR", on page 14.

Figure 7.0 Connecting the HHMPI to the FDR or CVR



3.2.2 Powering and charging the HHMPI

The HHMPI can be powered by:

- An aircraft powered recorder through an interface cable.
- A PC or USB adapter power through a USB cable (P/N: FDS400-107).
- The internal battery, on battery equipped HHMPI devices.
- The external battery, on Mod 2 HHMPI devices.

▼▲ Main Menu > Battery Status

To monitor battery status:

- Press **right** to open the **Main Menu**.
- Scroll **down** to **Battery Status** and press **OK**.

See Figure 8.0, "The Battery Status screen", on page 15.

Figure 8.0 The **Battery Status** screen

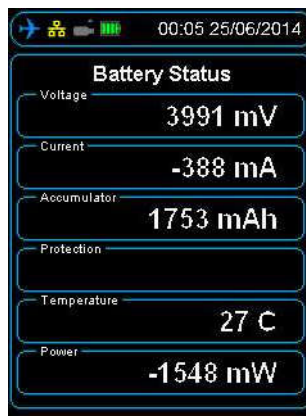

Battery powered HHMPI devices can be charged with:

- An aircraft powered recorder through an interface cable.
- A PC or USB adapter power through a USB cable (P/N: FDS400-107).
- A global power adapter kit (P/N: FDS400-322).

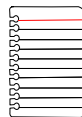

Note External battery powered HHMPI devices can only be charged with the external battery pack charge cable (P/N: FDS400-335).

Charge battery powered HHMPI devices for 12 hours before first use. Charging is indicated by a blue battery icon found in the status bar of the display. Full charge is indicated by a green four bar battery icon. When charging is required, this battery icon turns red.

You can use the HHMPI when it is charging, however this increases the charging time.

3.2.3 Charging the HHMPI with the docking cradle

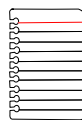

Note Only applicable to HHMPI devices with Mod 7.

HHMPI devices with Mod 7 can also be charged by a power adapter through the HHMPI docking cradle (P/N: FDS400-373).

To charge the HHMPI with the docking cradle:

1. Connect the power adapter to the docking cradle, the green light will illuminate.
2. Insert the HHMPI into the docking cradle, the HHMPI will beep and go through the start-up process, and then begin charging.
See Section 3.2.2, "Powering and charging the HHMPI" on page 14 for charging indicators.

Flight Data Systems recommends using the HHMPI Cradle for the following reasons:

- The cradle provides direct current (DC) charging which extends battery life by avoiding trickle charging.
- The transfer of files from the HHMPI to the PC is stable and easy to operate when docked.
- Auto-sync and transfer files from the unit to a nominated FTP server via Ethernet connection.
- Configure the unit in the web interface using the Ethernet connection on the cradle.

3.2.4 Turning on the HHMPI and self-test



Important When powering up the HHMPI ensure that no external devices are connected.

To turn on a battery powered HHMPI, press **cancel** or **OK** for 2–3 seconds until the unit beeps.

Once turned on, the start-up process begins and the power-on self-test is carried out. If connected, the interface cable is detected automatically, and correct connection to the flight data recorder is indicated by a blue aircraft icon found in the status bar of the display. See Figure 9.0, “HHMPI power-on sequence”, on page 16.

Figure 9.0 HHMPI power-on sequence



To turn off the HHMPI, press **cancel** until the **Confirm Power Off** alert is displayed, and then press **OK** to confirm.

3.2.5 Reset operation

If the HHMPI does not respond to normal key operation, a warm reset may be carried out by pressing the reset button for five seconds. This will reboot the HHMPI and return it to the shortcut screen. See Figure 3.0, “HHMPI bottom view”, on page 7 for the location of the reset button.

3.3 Shortcuts

Shortcuts are used to provide user's with a quick path to commonly used functions. There are four user defined shortcuts buttons.

▼▲ **Main Menu > Device Configuration > Shortcut Keys > Shortcut *n***

The HHMPI displays the shortcut keys following the start-up and self-test. The shortcut keys default to the following functions:

- Select Aircraft
- FDR All
- FDR Since Last
- Upload File (FTP)

3.4 Menu structure

The HHMPI is controlled by a menu system. The four arrow buttons are used to navigate the menu system. Generally, the **right** button is used to enter menus and the **OK** button is used to confirm selections.

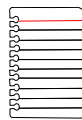

Note The menu options may change depending on the type of recorder or other devices attached.



Tip To return to the **Main** menu from any other menu, press **left** repeatedly.

3.5 HHMPI configuration

The HHMPI can be configured via a web interface, or directly on the unit. Using the web interface is the easiest way to set up the HHMPI, see Section 5.4.1, "Changing the HHMPI configuration via the web interface" on page 39.

3.5.1 Clock Settings

▼▲ **Main Menu > Device Configuration > Clock Settings**

Set the date and time format.

3.5.2 Display Settings

▼▲ **Main Menu > Device Configuration > Display Settings**

Set the brightness of the display, 1 is minimum brightness and 10 is maximum brightness.

3.5.3 Memory Settings

▼▲ **Main Menu > Device Configuration > Memory Settings**

Set the preferred memory to download or file transfer by selecting one of the following:

- Ask for device - Prompts the user to specify a device for download or file transfer.
- Priority list - Prioritize memory devices based on customised preference.
- User Specified Device - Set default memory device for storage and file transfer.

3.5.4 Network Settings

▼▲ **Main Menu > Device Configuration > Network Settings**

When connecting the HHMPI to a network connection via an Ethernet cable, setup IP, DHCP and FTP settings necessary for network operation. See Section 4.7, "Network operations" on page 33.

3.5.5 Aircraft Settings

▼▲ **Main Menu > Device Configuration > Aircraft Settings**

Set or edit aircraft tail numbers. See Section 4.2, "Aircraft lists" on page 19.

3.5.6 Security Settings

▼▲ **Main Menu > Device Configuration > Security Settings**

Set access to the menus and settings of the HHMPI by using password access by selecting the following:

- Restrict Configuration - Restrict modification of any HHMPI settings.
- Restrict Menus - Only allow access to previously configured shortcut keys.

3.5.7 Live Data Settings

▼▲ **Main Menu > Device Configuration > Live Data Settings**

Set the global live data settings to be used in the live data view from, some of these options may only be available for the L-3 Communications SRVIVR™™ interface:

- ARINC 717
- ARINC 429. Standard or periodic.
- DLR Settings. Select the data display format and data word description.

3.5.8 Shortcut Keys

▼▲ **Main Menu > Device Configuration > Shortcut Keys**

Set shortcut keys to change by selecting one of the options from the menu.

3.5.9 Settings Profile

▼▲ **Main Menu > Device Configuration > Settings Profile**

Save or load the device configuration to a file, or reset the configuration to the factory default settings:

- Load Settings
- Save Settings
- Reset Configuration

3.6 Information

All the information about the HHMPIs feature set, supported recorder types and the operating system version is found in the Information menu. This information may be useful for troubleshooting, see Section 7.0, "Troubleshooting" on page 44.

▼▲ **Main Menu > Information**

To access the HHMPI information, from the **Main Menu** press **down** until you reach the **Information** command, and then press **OK**. The information in the Asset, Company and Contact fields can be changed via the web interface, see Section 5.4.1, "Changing the HHMPI configuration via the web interface" on page 39. The remaining fields are only configurable by Flight Data Systems.

4.0 Operation

4.1 Download file name

Files downloaded from a recorder to the HHMPI follow a standard naming convention, configured by the **Filename Style** command on the **Settings** menu. The naming convention is: `_[aircraft tail number]_[date[_time]]_download type.ext`

For example:

- `_20101010_1204_FDR_5_MINUTES.fdr`
- `_VHFDS_101_20101010_1204_FDR_ALL.dlu`
- `_VHFDS_101_20101010_1204_CVR_ALL.cvr`

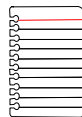

Note The file extension can vary according to the recorder type and download mode.

The date and time string use the time format already configured in the HHMPI.

Special characters within the aircraft tail numbers are automatically converted to underscores "_".

Dates and time stamps are stripped to remove slashes and colons.

4.2 Aircraft lists

Stored in the HHMPI as a comma separated variable file, the Aircraft List contains a list of all aircraft in the fleet. Using an Aircraft List makes it easier to assign tail numbers to operational downloads, it also makes the file names more readable.

4.2.1 Loading aircraft details

The Aircraft List may be created and stored in a HHMPI to populate the aircraft tail variable in the data file name. When an Aircraft List is not present, data file names will default to `_[aircraft tail number]_[date[_time]]_download type.ext`. See Section 4.1, "Download file name" on page 19.

4.2.2 Creating an Aircraft List on a PC

The Aircraft List can be created on a PC using a text editor, such as Notepad, or in a Spreadsheet application, such as Excel, and exported as comma separated variable (.csv) file. Figure 10.0, "Creating an Aircraft List in Notepad", on page 20.



Important The file must be named aircraft.csv and the data fields must be separated by a comma with each record separated by a carriage return (ASCII CR-LF).

Although not shown to the operator, the manufacturer field (MFCT) must also be present. However, the aircraft definition filed (DB) is only required for the Engineering Units (EU) function, see Section 4.5, "Viewing live flight data in engineering units" on page 29.

Figure 10.0 Creating an Aircraft List in Notepad

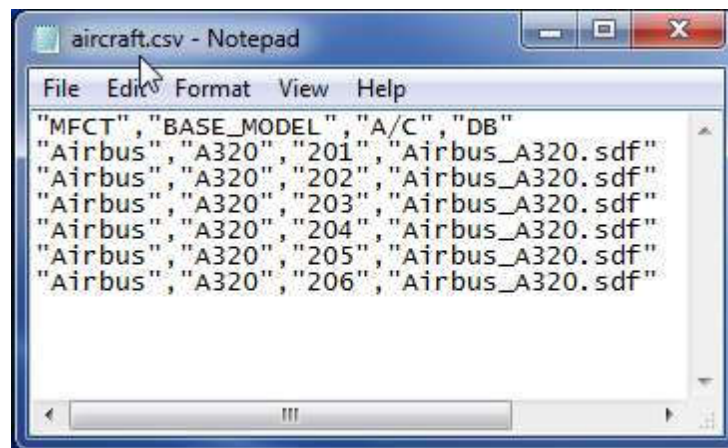

Save or export the file to a USB flash drive as aircraft.csv. If an Aircraft List is not present, data file names will default to *_[aircraft tail number]_[date[_time]]_download type.ext*.

4.2.3 Transferring the Aircraft List to the HHMPI

▼▲ **Main Menu > Device Configuration > Settings Profile > Load Aircraft**

To transfer the Aircraft List to the HHMPI, insert the USB flash drive containing the file named aircraft.csv into the USB port on top of the HHMPI.

1. From the **Main Menu**, press **down** until you reach the **Device Configuration** command, and then press **right**.
2. Press **down** until you reach the **Settings Profile** command, and then press **right**.
3. Press **down** until you reach the Load Aircraft command, and then press **right**.
4. Select where the file named aircraft.csv is located, and then press **right**.

4.2.4 Creating the Aircraft List on the HHMPI

▼▲ **Main Menu > Device Configuration > Aircraft Settings > Add Aircraft**



Tip For a large amount of aircraft, consider importing an Aircraft List as a comma separated variable file (aircraft.csv). See Section 4.2.2, "Creating an Aircraft List on a PC" on page 20.

To create, or add to, the Aircraft List on the HHMPI, from the **Add Aircraft** menu:

1. Press **down** until you reach the **Set Model** command, and then press **right**.
2. Press **up** to enter the alphabetical grid, and then press the **up, down, left** and **right** buttons to enter data.
3. When complete, press **cancel** to exit the alphabetical grid.
4. Press **OK** to confirm your selection.
5. Repeat steps 1 to 4 for **Set Tail**.
6. Press **down** until you reach the **Add** command, and then press **right** to confirm.
7. Press **OK** to confirm your selection.

To add additional aircraft, repeat steps 1 to 6 for each aircraft. See Section Figure 11.0, "Adding aircraft to the Aircraft List on the HHMPI" on page 21.

Figure 11.0 Adding aircraft to the Aircraft List on the HHMPI



4.2.5 Adding Entries to the HHMPI Aircraft File

See Section 4.2.4, "Creating the Aircraft List on the HHMPI" on page 21.

4.2.6 Deleting an aircraft from the Aircraft list on the HHMPI

▼▲ **Main Menu > Device Configuration > Aircraft Settings > Delete Aircraft**

To delete an aircraft from the Aircraft list on the HHMPI, from the **Device Configuration** menu:

1. Press **down** until you reach the **Aircraft Settings** command, and then press **right**.
2. Press **down** until you reach the **Delete Aircraft** command, and then press **right** to select the aircraft you want to delete.
3. Press **OK** to confirm the deletion.
Selected aircraft remain in the list but are marked by a red X.

4.2.7 Saving the Aircraft list to the USB flash drive on the HHMPI

▼▲ **Main Menu > Device Configuration > Settings Profile > Save Aircraft**

To save the Aircraft List to a USB flash drive, insert a USB flash drive into the USB port on the top of the HHMPI, and from the **Device Configuration** menu:

1. Press **down** until you reach the **Settings Profile** command, and then press **right**.
2. Press **down** until you reach the **Save Aircraft** command, and then press **right** to save onto **USB Flash Drive**.



Important The Aircraft List is saved to the USB flash drive as aircraft.csv.bkp. To transfer this file to the HHMPI again, it must be renamed aircraft.csv.



Tip The saved aircraft.csv file can be used as a template to add more aircraft or aircraft definition files (databases) to the Aircraft List.

4.2.8 Deleting all aircraft from the Aircraft list on the HHMPI

▼▲ **Main Menu > Device Configuration > Aircraft Settings > Erase All Aircraft**

By selecting this option all the aircraft models and tail numbers in the Aircraft List will be removed from the HHMPI. Press **OK** to confirm or **cancel** to cancel this operation.

4.2.9 Prompt for Tail No.

▼▲ **Main Menu > Device Configuration > Aircraft Settings > Prompt for Tail No.**

Enabling the **Prompt for Tail No.** command forces a user to assign a tail number to an operational download. This ensures that a download file name contains the aircraft tail number, which may help in traceability of data and further analysis.

Figure 12.0 Configuring the prompt for tail number option

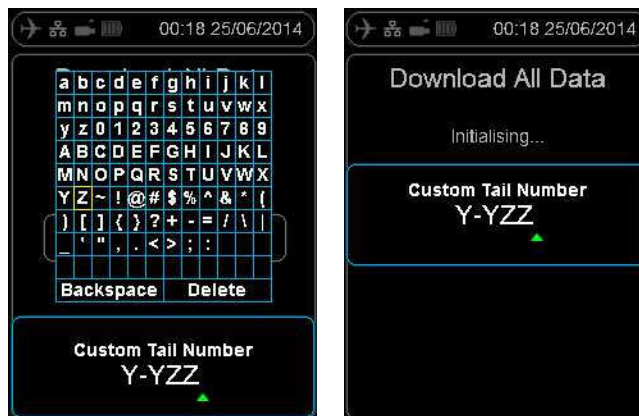

4.3 Downloading flight data

The HHMPI can be used to download recorded data from the FDR and voice from the CVR. It is connected to the recorder via an interface cable which identifies the attached recorder type. When downloading flight data, the following procedure is generally used:

- Create the Aircraft List, if required. See Section 4.2, "Aircraft lists" on page 19. The Aircraft List may be created and stored in a HHMPI to populate the *aircraft tail* variable in the data file name. The *manufacturer* and *model* variables are not used in the data file name.
- Select the aircraft, model and tail number from the Aircraft List.

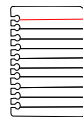

Note If this step is omitted the file name will only include the time stamp. If you want to force users to assign a tail number before an operational download enable the **Prompt for Tail No.** command. See Section 4.2.9, "Prompt for Tail No." on page 22.

- Start downloading flight data as follows.

4.3.1 Downloading recorded data from the FDR to a USB flash drive

To download flight data from the FDR to a USB flash drive:

1. Connect the HHMPI to the FDR with an interface cable, see Figure 7.0, "Connecting the HHMPI to the FDR or CVR", on page 14.
2. Turn on the HHMPI and FDR. Once turned on, the start-up process begins and the power-on self-test is carried out. If connected to the HHMPI, the interface cable is detected automatically, and correct connection to the FDR is indicated by a blue aircraft icon found in the status bar of the display.
3. Plug the USB flash drive into the USB port on the top of the HHMPI. An alert, **USB Drive Inserted**, should appear momentarily. An orange USB flash drive icon will also appear in the status bar indicating the HHMPI is ready to write to the USB flash drive.

▼▲ **Main Menu > Download Operations**

4. From the **Main Menu**, press **down** until you reach the **Download Operations** command, and then press **right**. Then press **down** until you reach the data you want to

download, and then press **right**. There is usually four download commands, depending on the type of recorder:

- **FDR All**, downloads all the available data.
 - **FDR Since Last**, downloads all the data recorded since the last download.
 - **FDR Mark**, downloads the data from a pre-recorded marker.
 - **FDR Time**, downloads data for a specified time, for example, 20 minutes will download the last 20 minutes recorded.
5. If an external storage device, like a USB flash drive, is plugged into the HHMPI, you may now select to store the data onto this device. To start downloading the data, press **right**.

The display will now show the download progress. When the download completes, press **OK**.



Tip You can set the preference of external storage devices from the **Memory Settings** menu. For example, prioritise the USB flash drive, when present, over the HHMPI internal memory.

Figure 13.0 Downloading progress bar



4.3.2 Decompressing CVR data at the aircraft

To play CVR files on a computer or another device, you may need to decompress the raw file into a waveform file (.wav). See Section 4.3, "Downloading flight data" on page 23.

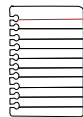

Note To decompress CVR data at the aircraft, the de-multiplexing feature needs to be enabled on the HHMPI. Contact Flight Data Systems for more information about this feature.

After selecting CVR download, the **De-multiplex to Wave** option will appear. Press the **OK** button to decompress the raw CVR file to waveform files. Generally there will a waveform for each channel recorded on the CVR. If you do not want to decompress the raw

CVR file to waveform files, press the **cancel** button. See Section Figure 14.0, "Downloading and decompressing CVR data" on page 25.

After the download completes, the raw CVR file and the waveform files from each channel will be available on the nominated storage device. These files can be transferred to a computer or another device where they can be replayed. A codec may need to be installed, this is included as part of the HHMPI kit.

Figure 14.0 Downloading and decompressing CVR data



4.3.3 Decompressing CVR away from the aircraft

▼▲ Main Menu > Utilities > Decompress DLU

From the home screen, press **right** to access the **Main Menu**, scroll down to the **Utilities** command, and then press **OK**.

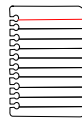

Note To decompress CVR data away from the aircraft, the de-multiplexing feature needs to be enabled on the HHMPI. Contact Flight Data Systems for more information about this feature. Decompression of CVR data away from the aircraft also only applies to Honeywell CVRs.

On the **Decompress DLU** command, press **OK**, and then select the raw .dlu file to decompress and the decompression process will begin.

Figure 15.0 Decompressing Honeywell CVR file away from the aircraft

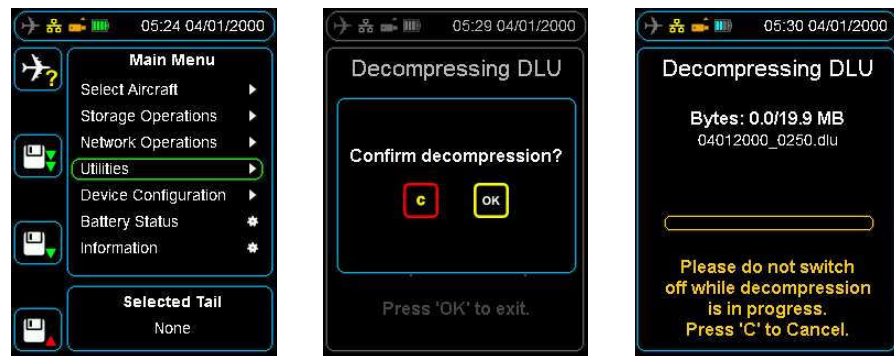

After the decompression completes, the raw CVR file and the waveform files from each channel will be available on the nominated storage device. These files can be transferred to a computer or another device where they can be replayed. A codec may need to be installed, this is included as part of the HHMPI kit.

4.3.4 Using the CVR rack adapter

To download the CVR data, record mode must be disabled. Without disabling record mode, you cannot download CVR data. Use the CVR rack adapter to power the CVR from aircraft power by plugging it into aircraft power and then into the rear of the CVR. Once powered, recording is disabled on the CVR and the data is ready to download.

4.3.4.1 Using the Honeywell CVR Rack Adaptor part number FDS400-215

- Firstly ensuring no power is provided to the CVR, disconnect the aircraft power from the back of the Honeywell CVR while in the rack.
- Connect the CVR Rack adaptor into the back of the CVR and reconnect aircraft power to the CVR Rack adaptor instead.
- Power the CVR at the aircraft and then connect the HHMPI interface cable (connected to the Rack Adaptor) to the HHMPI and start up the unit.
- With CVR recording now disabled using the Rack Adaptor ensure the blue plane appears in the HHMPI and begin a CVR download at the aircraft.

4.3.4.2 Using the L-3 CVR Rack Adaptor part number FDS400-247

- The L-3 CVR Rack Adaptor is almost the same design as the Honeywell. The difference is it doesn't have nor require the Interface cable connection to the HHMPI.
- Connect the L-3 CVR Rack Adaptor the same way as instructed with the Honeywell CVR Rack Adaptor. Ensure Aircraft power is switched off to the CVR when plugging in the adaptor to the CVR then the aircraft power connection.
- Using the additional cable - The FA2100 Interface Cable P/N FDS400-202 insert this into the CVR front GSE connector and then into the HHMPI. Power the CVR and power the HHMPI. Ensure the blue plane appears in the HHMPI and begin a CVR download at the aircraft.

4.4 Viewing live flight data

The HHMPI can be used to monitor live ARINC 717 data from the aircraft. The Live Data View can display data from the FDR in five formats:

- Binary (Base 2)
- Octal (Base 8)
- Decimal (Base 10)
- Hexadecimal (Base 16)
- Engineering units (EU)

The Live Data View display options are accessible via the **shortcut** buttons 1–4.

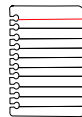

Note These menu items will only be visible where they are supported by the connected FDR/CVFDR.

To view live data from the FDR:

1. Connect the HHMPI to the FDR with an interface cable, see Figure 7.0, “Connecting the HHMPI to the FDR or CVR”, on page 14.
2. Turn on the HHMPI and the FDR. Once turned on, the start-up process begins and the power-on self-test is carried out. If connected to the HHMPI, the interface cable is detected automatically, and correct connection to the FDR is indicated by a blue aircraft icon found in the status bar of the display.

▼▲ **Main Menu > Live Data View > View Live FDR Data > View ARINC 717 Data**

3. From the **Main menu**, press **down** until you reach the **Live Data View** command, and then press **right**. Then press **down** until you reach the **View Live FDR Data** command, and then press **right** to **View ARINC 717 Data**. See Figure 16.0, “Viewing live data”, on page 27.
4. Wait until the HHMPI synchronizes with the FDR, while synchronizing, **UNKNOWN** is displayed on the screen. After synchronizing, you can view live data from the aircraft parameters.

For more information about formatting and displaying data on the HHMPI, see Section 4.4.2, “Adjusting ARINC 717 settings” on page 28 and Section 4.4.3, “Changing the display format” on page 28.

Figure 16.0 Viewing live data

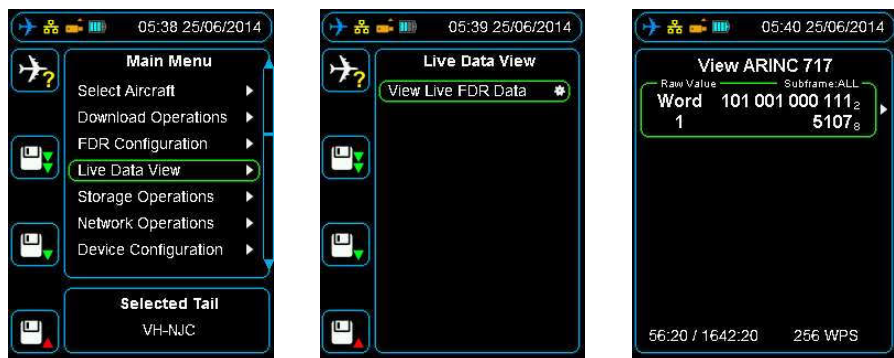

4.4.1 Live Data View Options

Multiple ARINC 717 words can be displayed simultaneously, these words are selected using the **shortcut** buttons 1 to 4.

4.4.2 Adjusting ARINC 717 settings

▼▲ Main Menu > Live Data View > View Live FDR Data > View ARINC 717 Data

To access the ARINC 717 settings, press **right** on a selected parameter / word cell. The following options will be displayed:

- **Word Offset**, selects the current word from 1 to 2048. To change the Word Offset number, use the **up**, **down**, **left** and **right** buttons, and then press **OK** to confirm your selection.
- **Sub-frame**, selects the sub-frame to view from 1 to 4, or ALL. ALL is the default value for this setting. To change the sub-frame, use the **up** and **down** buttons, and then press **right** to confirm your selection.
- **Viewing Mode**, provides the option to view live data in the following formats: Binary-Octal, Binary-Decimal and Binary-Hexadecimal. To change the viewing mode, use the **up** and **down** buttons, and then press **right** to confirm your selection.
- **MSB** (Most Significant Bit), hides all binary bits in the word before the MSB. To change the MSB, use the **up** and **down** buttons, and then press **right** to confirm your selection.
- **LSB** (Least Significant Bit), hides all binary bits in the word after the LSB. To change the LSB, use the **up** and **down** buttons, and then press **right** to confirm your selection.

4.4.3 Changing the display format

Figure 17.0 ARINC 717 settings

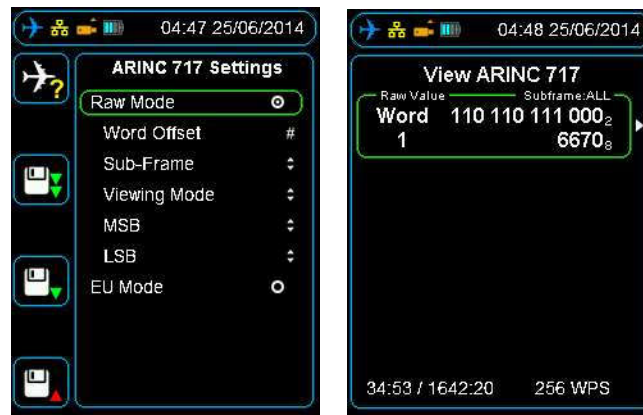

Simultaneous words can be displayed if required by using **shortcut** buttons 1 to 4. See Figure 18.0, "Multiple live data view", on page 29.

Parameters for each displayed Live Data Word-Offset can be modified. See Section 4.4.3, "Changing the display format" on page 28.

Figure 18.0 Multiple live data view



Tip Word Offset can be adjusted by the following:

Main Menu > Live Data View > View Live FDR Data > View ARINC 717 Data > Up | Down | Left | Right

Figure 19.0 Word offset adjust



4.5 Viewing live flight data in engineering units

To view the live flight data in Engineering Units (EU Mode), you must associate an Aircraft Definition file with an aircraft. The Aircraft Definition file is exported from STARS with the extension .sdf. You will need to transfer this file to the HHMPI either through a direct USB

connection, where the HHMPI will be picked up as an external storage device, or via one of the removable memory options such as an SD memory card, or USB flash drive.

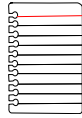

Note To view live data in engineering units, the engineering units feature needs to be enabled on the HHMPI. Contact Flight Data Systems for more information about this feature.

4.5.1 Assigning an Aircraft Definition file to an aircraft

▼▲ **Main Menu > Device Configuration > Aircraft Settings > Assign Database > Aircraft Tail Number**

To assign an Aircraft Definition file to an aircraft:

1. From the **Main Menu**, select **Device Configuration**, and then select **Aircraft Settings**.
2. From the **Aircraft Settings** menu, select **Assign Database**, and then select the **Aircraft Tail Number** you want to assign the Aircraft Definition file to.
3. Locate and select the .sdf file as exported from STARS.
4. Press **OK** to confirm the assignment of the Aircraft Definition file to the aircraft. Once complete, the HHMPI will display a notification that the assignment was successful. See Section 4.4, "Viewing live flight data" on page 26.

4.5.2 Viewing Live Flight Data

▼▲ **Parameter / Word Cell > Select Parameter > First Letter of Parameter > Parameter > OK**

After assigning an Aircraft Definition file to an aircraft, see Section 4.5.1, "Assigning an Aircraft Definition file to an aircraft" on page 30, to view the live flight data in Engineering Units:

1. To view live flight data in Engineering Units, you must select an aircraft which already has an Aircraft Definition file (database) assigned to it. To select an aircraft, from the **Main Menu**, press **right** on the **Select Aircraft** command, and then press **right** on the aircraft you want to view the live flight data from. The selected tail number will appear on the shortcut screen. See Figure 20.0, "Selected tail number on the shortcut screen", on page 31.

Figure 20.0 Selected tail number on the shortcut screen



2. Follow the procedure in Section 4.4, "Viewing live flight data" on page 26 and wait until the HHMPI synchronizes with the FDR, while synchronizing, **UNKNOWN** is displayed on the screen.
3. Press a **shortcut** button to select a parameter / word cell.
4. Press **right** to display the **ARINC 717** settings menu.
5. Enable the **EU Mode** radio button, then press **down** until you reach the **Select Parameter** command, and then press **right**. An alphabetical list will be displayed, see Figure 22.0, "Accessing aircraft parameters alphabetically", on page 32.

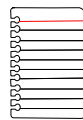

Note The EU Mode radio button will only appear if an aircraft had been selected that has an Aircraft Definition file (database) assigned to it.

Figure 21.0 Changing from Raw Mode to EU Mode



Figure 22.0 Accessing aircraft parameters alphabetically

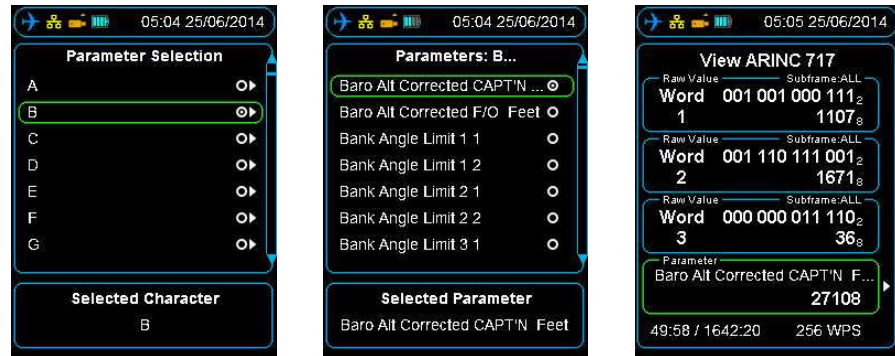

6. Press **right** on the first letter of the parameter you want to look at, and then press **right** again. This command will display all the parameters starting with the letter you have selected.
7. Press **OK** twice to return to the ARINC 717 view. The selected parameter / word cell will now display live data according to the algorithm in the configured database. As in the raw data view, up to four parameters / word cells can be displayed and configured independently. Values will update once per sub-frame and **SAMPLING** will flash green and white for each update. See Section Figure 23.0, "Four parameters populated with Engineering Units" on page 32.

Figure 23.0 Four parameters populated with Engineering Units



4.6 File transfer operations

4.6.1 File transfer between HHMPI storage locations

▼▲ Main Menu > Storage Operations > Select Files | Select All Files

The general method of transferring files between connected memory devices is:

- From the **Main** menu press the **down** button until you reach the **Storage Operations** command, and then press the **right** button on either the **Select Files** or **Select All Files** command, and then select the preferred memory device.

- Select the file(s) by pressing the **right** button.
- Press the **left** button to return to the **Storage Operations** menu.
- Select **Copy Files** then **Select Memory Device** and press the **right** button to confirm.
- To delete, select **Delete Files**.

4.6.2 Other storage operations

To determine the storage used on any memory device, from the **Storage Operations** menu, press the **right** button on the **Storage Usage** command, and then press the **cancel** button to exit.

▼▲ **Main Menu > Storage Operations > Storage Usage**

To format a memory device, from the **Storage Operations** menu, press **right** on the **Format** command, and then select the memory device you want to format.

▼▲ **Main Menu > Storage Operations > Format > Select Memory Device**

4.6.3 File transfer PC to HHMPI

When connected to a PC the internal memory of the HHMPI will appear as a write-protected external hard drive, therefore files may only be copied from the HHMPI to the PC. To erase files from the HHMPI internal memory, see Section 4.6.1, "File transfer between HHMPI storage locations" on page 32.

4.7 Network operations

The HHMPI is capable of transferring files over a network using FTP and also for device configuration in any web browser.

4.7.1 DHCP network settings

To view DHCP (automatic) network settings:

▼▲ **Main Menu > Device Configuration > Network Settings > Wired Settings**

- Navigate to **Wired Settings** as above.
- Select **Enable Networking**, checking or un-checking the check box enables or disables the **Manual Configure** IP address option.
- Choose between **Auto** and **Manual DHCP**.
- **Auto Configure DHCP** by setting the checking the check box.

OR

- Manually configure the IP address by pressing right on the **Manual Configure** command.
- Use the up button to set the **IP Address**, **Netmask** and **Gateway**.
- Press the **OK** button.
- See Figure 24.0, "DHCP or manual IP configuration", on page 34.

To view HHMPI IP address:

▼▲ **Main Menu > Network Operations > View Wired Address > Adaptor: eth0**

Figure 24.0 DHCP or manual IP configuration

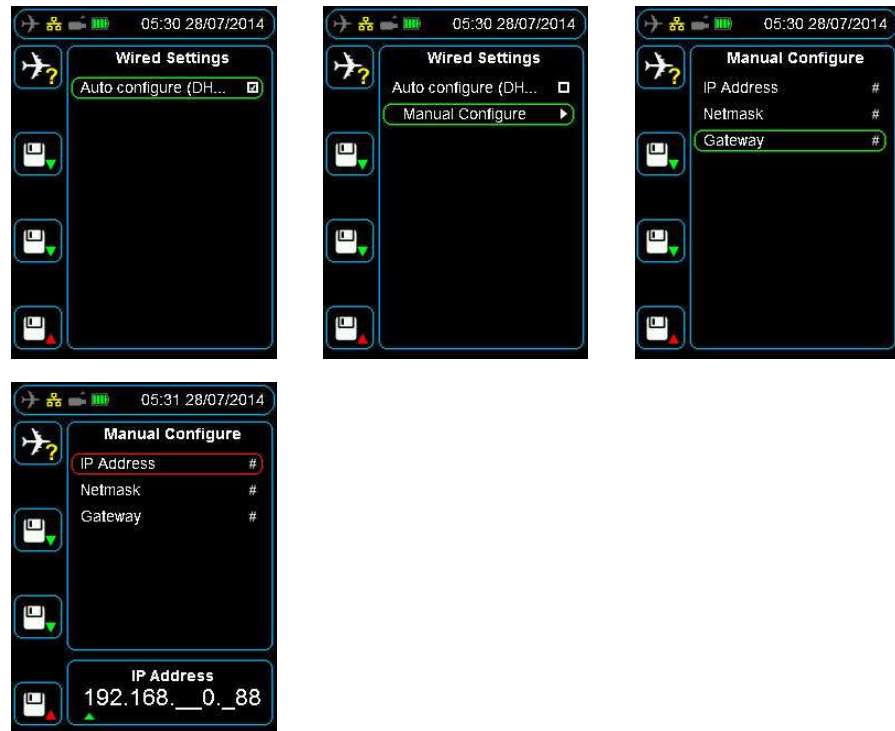

5.0 Configuring an FTP connection

Before you can upload files from the HHMPI to a server, you need to configure the FTP server settings. You can do this from the HHMPI or through the web interface. Using the web interface is the easiest way to configure the FTP server settings.

5.1 Adding a new FTP server from the HHMPI

To add a new FTP server from the HHMPI, from the **Main** menu:

▼▲ **Main Menu > Device Configuration > Network Settings > FTP Servers > Add FTP Server**

1. Press **down** until you reach the **Device Configuration** command, and then press **right**. Then press **down** until you reach the **Network Settings** command, and then press **right**. Then press **down** until you reach the **FTP Servers** command, and then press **right**. See Figure 25.0, "Setting up the FTP client", on page 35.

2. Ensure you have access to the FTP server and the FTP server settings, including the IP address, username, password, and the encryption type. This FTP server information is usually available from your IT department.
3. From the **FTP Servers** menu, press **down** until you reach the **Add FTP Server** command, and then press **right**. To add a FTP server name, press **up** to enter the name from the alphabet grid with the arrow buttons, pressing **OK** between each letter. When complete, press **cancel** to exit the alphabet grid, and then press **OK** to confirm your selected FTP server name.



Tip The FTP server name is not used in connection to the FTP server, you can give the FTP server any name.

Figure 25.0 Setting up the FTP client

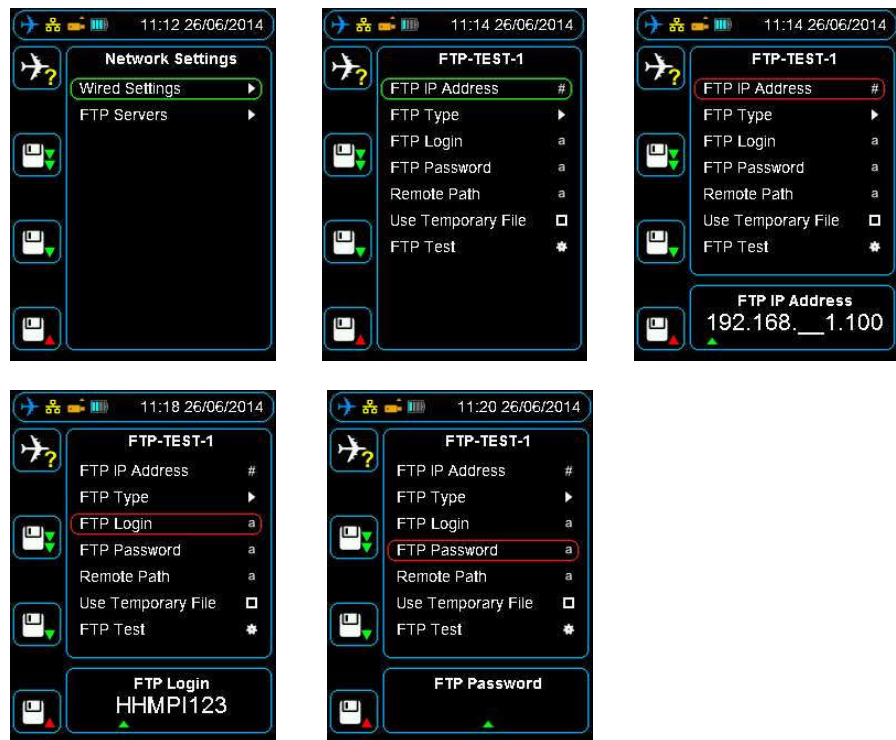

5.2 Configuring an existing FTP server from the HHMPI

To configure an existing FTP server, from the **FTP Servers** menu, press **down** until you reach the FTP server name you want to configure, and then press **right**. Then do one of the following:

1. To save an IP Address, press **right** on the **FTP IP Address** command. To enter the IP Address, press **up** or **down** on each number, and then press **OK** to confirm your selection.

2. To save an FTP Type, press right on the **FTP Type** command, and then press **down** until you reach the FTP type you want, and then press **right**. The HHMPI supports three FTP types:
 - **FTP (port 21)**, unsecured transmission on port 21
 - **FTP over SLL**, secured transmission that encrypts the username and password, and content with SSL
 - **FTP over SSH**, secured transmission that encrypts the username and password, and content with SSH
3. To save an FTP username, press **right** on the **FTP Login** command, and then press **up** to enter the username from the alphabet grid with the arrow buttons, pressing **OK** between each letter. When complete, press **cancel** to exit the alphabet grid, and then press **OK** to confirm the username.
4. To save an FTP password, press **right** on the **FTP Password** command, and then press **up** to enter the password from the alphabet grid with the arrow buttons, pressing **OK** between each letter. When complete, press **cancel** to exit the alphabet grid, and then press **OK** to confirm the password.
5. To save a Remote Path, press **right** on the **Remote Path** command, and then press **up** to enter the remote path from the alphabet grid with the arrow buttons, pressing **OK** between each letter. When complete, press **cancel** to exit the alphabet grid, and then press **OK** to confirm the remote path.

The Remote Path field controls which folder the file is uploaded to on the FTP server. Depending on the FTP server configuration, this may be an optional field. Leaving the remote path blank means the file will be uploaded to the default folder your FTP account logs into.

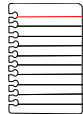

Note Select the **Use Temporary File** check box if the HHMPI is to use a temporary file when uploading. When the upload is complete, this temporary file is renamed to the final file name. This is useful for ensuring that remote systems do not read a partially uploaded file.

Disable this option if the remote server reports a “rename failed” error and leaves a temporary file with the extension -upload, and the channel stops. This typically means that the server is employing its own temporary file mechanism that is incompatible with the HHMPI).



Caution Using an unsecured FTP connection may result in the loss of sensitive information. See your IT department or contact Flight Data Systems for more information on encryption.

Figure 26.0 FTP type menus

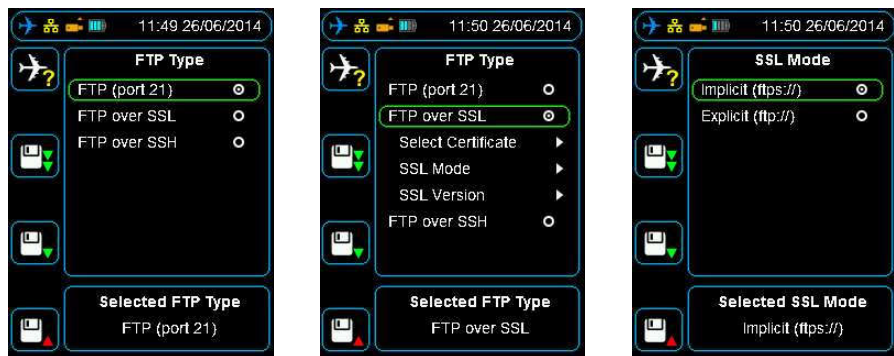
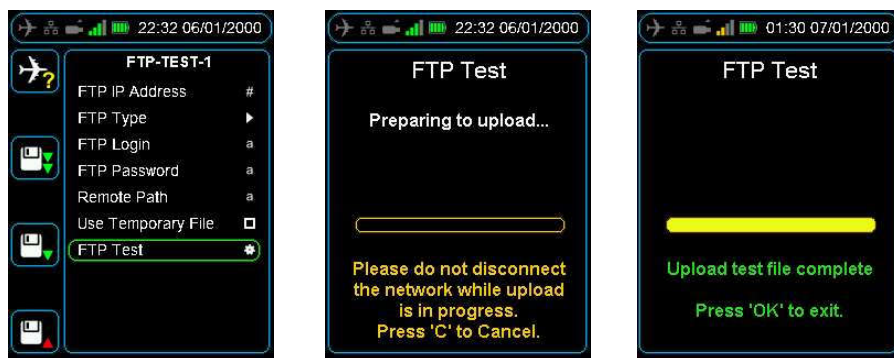

Figure 27.0 Login, password, remote path and FTP test



5.3 Testing an FTP server from the HHMPI

To test an FTP connection, from the **FTP Servers** menu, press **down** until you reach the FTP server name you want to test, and then press **right**. Then press **down** until you reach the **FTP Test** command, and then press **right**. See Figure 27.0, “Login, password, remote path and FTP test”, on page 37.

5.4 Setting up an FTP connection from the web interface

You can configure the HHMPI through the web interface in any web-browser. Using the web interface is the easiest way to configure the HHMPI.

▼▲ Main Menu > Network Operations > View Wired Address

To access the HHMPI web interface:

1. Connect the HHMPI to the local area network (LAN) router or switch which will allocate a unique IP address.
2. From the **Main** menu, press **down** until you reach the **Network Operations** command, and then press **right**. Then press **down** until you reach the **View Wired Address** command, and then press **right**.
If the HHMPI is assigned an IP address it will now be displayed, if no link is detected **No Link Detected** will be displayed.
3. Record the IP address. See Figure 28.0, “Viewing the wired IP address”, on page 38.

Figure 28.0 Viewing the wired IP address

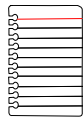

Note If no link is detected an IP address has not been assigned to the HHMPI, this may be because of your network security settings. See your IT department or contact Flight Data Systems for more information if this occurs.

1. Open a web-browser such as Mozilla Firefox or Google Chrome and type the wired IP address into the browser's address bar.
2. Login to the HHMPI web interface using the default username and password:
Username: admin
Password: admin
See Figure 29.0, "Web interface login", on page 38.

Figure 29.0 Web interface login

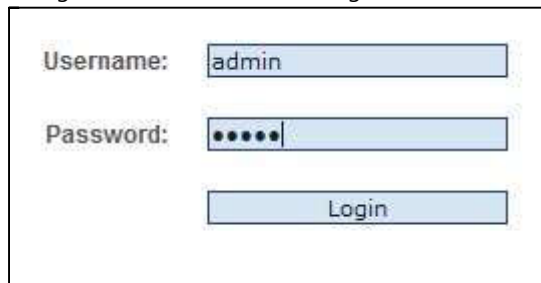

Figure 30.0 Web interface screen



The HHMPI web interface has five tabs:

- **System Information**, displays the device and software version information.
- **Device Configuration**, displays the device configuration, including network settings and wireless settings.
- **Backup/Restore**, allows you to backup or restore the device configurations.
- **File Browser**, displays a list of the files in the HHMPI internal memory for download.
- **Admin**, displays the administrators configuration, including owner information and access restrictions.

5.4.1 Changing the HHMPI configuration via the web interface

To configure the HHMPI through the web interface, in any web-browser:

1. Log on to the HHMPI web interface per Section 5.4, "Setting up an FTP connection from the web interface" on page 37.
2. Click the **Device Configuration** tab, see Figure 31.0, "Device configuration screen", on page 40. The **Device Configuration** screen allows you to configure everything you can on the HHMPI, including network settings and wireless settings.
3. Save any changes you make, and then click **Apply** to write the changes to the HHMPI flash memory.

Figure 31.0 Device configuration screen



5.4.2 Backing up the HHMPI configuration

To back up the HHMPI settings, aircraft list and SSL certificate (if installed) through the web interface, in any web-browser:

1. Log on to the HHMPI web interface per Section 5.4, "Setting up an FTP connection from the web interface" on page 37.
2. Click the **Backup/Restore** tab, see Figure 31.0, "Device configuration screen", on page 40. The **Backup/Restore** screen allows you to back up the device configuration, aircraft list and SSL certificate (if installed) in order to restore it later.
3. Click **Aircraft List**, and then click **Save**.
4. Repeat steps 1 to 3 to back up the configuration file and the SSL certificated (if installed).

Figure 32.0 Device configuration screen



5.4.3 Restoring backup files via the web interface



Important The Aircraft List is saved to the USB flash drive as aircraft.csv.bkp. To transfer this file to the HHMPI again, it must be renamed aircraft.csv.

To reload aircraft.csv or an SSL certificate follow these steps:

1. Select the file to be uploaded, e.g. aircraft.csv or hhmpi.conf.
2. Press the **Upload** button. Press **Apply** once the upload has finished, and the changes will be saved in flash memory in the HHMPI.

5.4.4 Administration settings

The Admin Screen allows users to:

- Add owner information.
- Enter pass codes for restricting configuration or restricting main menu access.
- Change the administrator login.
- Reset the device or restore back to factory settings.

Figure 33.0 Device configuration screen

The screenshot shows a web interface for device configuration. It features a blue header with a minus sign and the text 'USB Settings'. Below this are two rows: 'Mass Storage Device:' and 'MPI Device:', each with a radio button. A dark grey bar labeled 'Admin' contains a 'Save' button on the right. Underneath is another blue header with a minus sign and 'Owner Information'. This section includes four rows: 'Device Description:' with a text box containing 'Hand Held Multi-Purpose Interface', 'Asset Number:', 'Company Name:', and 'Contact Person:', each with an empty text box. Below is another blue header with a minus sign and 'Access Restrictions'. This section has two rows: 'Restrict Menus:' with a checkbox and a 'Passcode:' text box containing '0000', and 'Restrict Config:' with a checkbox and a 'Passcode:' text box containing '0000'.

To change admin settings follow these steps:

1. From the **Access Restrictions** collapsible menu, set the new passcode and then click **Save**.
2. The next time you turn on the HHMPI the new passcode will take effect when attempting to access the main menu.

5.4.5 Logging out of the web interface

To log out of the web interface press the **Logout** button below.

Figure 34.0 Logout button

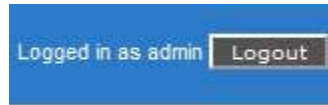

6.0 Wirelessly uploading files from the HHMPI to a server

6.1 Setting up a wireless network connection

Some HHMPI models, when in range of a wireless network, support the wireless upload of files from the HHMPI to a server. This upload method uses a USB wireless network adapter plugged into the USB port on top of the HHMPI.

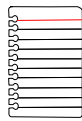

Note The HHMPI must include the wireless option which enables support for the wireless upload of files from the HHMPI to a server.

USB flash drives cannot be used when connected to a wireless network.

6.1.1 Required equipment and wireless network information

To wirelessly upload files from the HHMPI to a server, you will need:

- A HHMPI with the wireless option enabled.
- A USB wireless network adaptor.
- Access to a wireless network, including the SSID (or the public name of the wireless network), and the encryption type and key. This wireless network information is usually available from your IT department.

6.1.2 Turning on wireless network support

To wirelessly upload files from the HHMPI to a server, when in range of a wireless network:

▼▲ **Main Menu > Device Configuration > Network Settings > Enable Networking > Wireless Network**

1. Turn on the HHMPI.
2. Plug the USB wireless network adapter into the USB port on the top of the HHMPI. An alert **Configuring Wi-Fi - Please Wait** should appear momentarily. A white antenna icon will also appear in the status bar indicating the HHMPI is ready to connect to wireless networks in range.
3. From the **Main** menu, press **down** until you reach the **Device Configuration** command, and then press **right**. Then press **down** until you reach the **Network Settings** command, and then press **right**. See Figure 35.0, "Connecting to a wireless network", on page 43.
4. Press **right** to select the **Enable Networking** check box.
5. Press **down** until you reach **Wireless Network**, and then press **right** to **Scan** for wireless networks in range, or add a wireless network manually with an **ESSID**.

Figure 35.0 Connecting to a wireless network

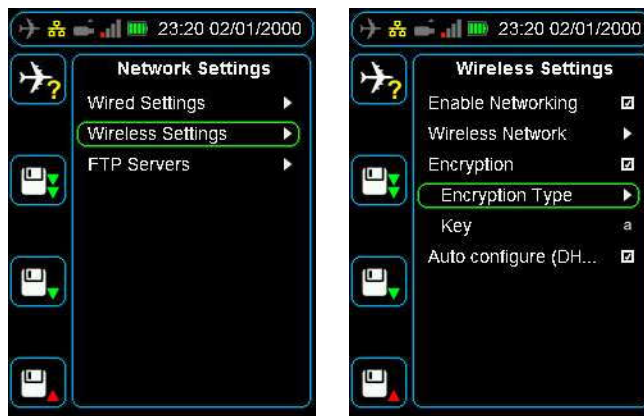

6.1.3 Connecting to a wireless network

To connect to a wireless network, it is likely that you will need to configure some security settings like the encryption type and key. To turn on encryption, from the **Wireless Settings** menu:

- Press **down** until you reach the **Encryption** command, and then press **right** to select the **Encryption** check box.

To select an encryption type and enter a key, from the **Wireless Settings** menu:

1. Press **down** until you reach **Encryption Type** command, and then press **right** to select the encryption type from the following commands: **WEP**, **WPA1**, and **WPA2**.
2. Press **left** to return to the **Wireless Settings** menu, then press **down** to select the **Key** command, and then press **right** to enter the key.
3. Press **up** to enter the key from the alphabet grid with the arrow buttons, pressing **OK** between each letter. When you are finished, press **cancel** and then **OK** to return to the **Wireless Settings** menu.

If you have successfully connected to a wireless network, the white antenna icon in the status bar will change to a green four bar signal strength icon. If this signal strength icon does not appear, you are not connected to a wireless network and may need to contact your IT department.



Caution Using an unsecured wireless network may result in the loss of sensitive information. See your IT department or contact Flight Data Systems for more information on encryption.

To save the encryption type and key, from the **Device Configuration** menu:

- Press **down** until you reach the **Save Settings** command, and then press **right**.

Figure 36.0 Configuring security settings like the encryption type and key



6.1.4 Uploading files via FTP with a wireless network connection

When the HHMPI is connected to a wireless network, files saved on the HHMPI, or on one of its external storage devices, can be uploaded wirelessly to a server via FTP.

To upload files via FTP with a wireless network connection, ensure:

- That the HHMPI is connected to a wireless network. From the **Main menu**, press **down** until you reach the **Network Operations** command, then press **down** until you reach the **View Wireless Address** command, and then press **right**. If the HHMPI is connected to a wireless network it will display an IP address assigned by the wireless router.
- That the FTP settings have been configured. See Section 5.0, "Configuring an FTP connection" on page 34.

7.0 Troubleshooting

To troubleshoot the HHMP, first try the following steps:

- **Turn the HHMPI on and off** by following the steps in Section 3.2.4, "Turning on the HHMPI and self-test" on page 16.
If this did not work, try connecting the HHMPI to a power adapter and plug the power adapter into an electrical outlet, or connect the HHMPI to your computer. Make sure the computer is turned on and isn't set to go to sleep.
If this does not work, try resetting the HHMPI by following the steps in Section 3.2.5, "Reset operation" on page 16.
- **Retry** the HHMPI with a different recorder if possible.
- **Restart** the recorder if possible and try again.

▼▲ **Main Menu > Device Configuration > Report Error**

If these steps do not solve your problem, below is a list of potential problems and solutions. If your problem is not listed, use the **Report Error** menu option (if possible) on the HHMPI, and send the generated file to support@flightdata.com.au with a description of

the problem, the serial number of the HHMPI, and the part numbers of recorders you are trying to interface with (if applicable).

If it is not possible to report the error on the HHMPI, send an email to support@flight-data.com.au. In your email, include the following information:

- Company name and contact details.
- Any relevant part numbers, serial numbers and mod status of the Flight Data Systems equipment involved in your troubleshooting process. See Section 3.6, "Information" on page 19.
- Any part numbers and a brief description of any equipment not manufactured by Flight Data Systems involved in your troubleshooting process.
- Reported fault, including as much information about the conditions when the fault occurs.
- Once your email has been received, we will investigate your issue and contact you as soon as possible.

Table 7.0 Troubleshooting common issues with the HHMPI

| Issue | Solution |
|---|--|
| HHMPI does not power up. | Battery requires charge, for battery equipped units. For HHMPIs without an internal battery, ensure that it is connected to a powered recorder. |
| Screen is not visible | Reset the HHMPI by following the steps in Section 3.2.5, "Reset operation" on page 16. |
| No communication between the HHMPI and the recorder | Ensure that the HHMPI is configured for the recorder, see System Information in Section 5.4.1, "Changing the HHMPI configuration via the web interface" on page 39. Ensure that no external memory device is inserted during start-up. Ensure that the aircraft interface cable is correctly inserted. |
| Unable to download file from recorder | Select a memory device, see Section 3.5.3, "Memory Settings" on page 17. Ensure that the aircraft interface cable is correctly inserted. Ensure that the HHMPI is configured for the recorder, see System Information in Section 5.4.1, "Changing the HHMPI configuration via the web interface" on page 39. Check the aircraft interface cable for damage. Check the aircraft interface cable for any debris that could be causing connection issues. |
| A message is displaced indicating that the download has stopped or stalled. | Cancel and restart the download. |

Table 7.0 Troubleshooting common issues with the HHMPI

| Issue | Solution |
|---|--|
| <p>Cannot see live data in the live data view, only see unknown values.</p> | <p>Ensure correct connection to the recorder. Connection is indicated by a blue aircraft icon found in the status bar of the display.</p> <p>If you want to view the live data in engineering units, ensure that the aircraft has an aircraft definition (database) associated with it, see Section 4.5.1, "Assigning an Aircraft Definition file to an aircraft" on page 30.</p> <p>Ensure FDR is in correct mode.</p> <p>Restart the recorder if possible, and try again.</p> |
| <p>Cannot get IP address through wired network.</p> | <p>Ensure that an Ethernet cable is connected, and ensure correct connection to the recorder. Connection is indicated by a yellow network connection icon found in the status bar of the display. See Section 3.5.4, "Network Settings" on page 18.</p> <p>If no link is detected an IP address has not been assigned to the HHMPI, this may be because of you network security settings. See your IT department or contact Flight Data Systems for more information if this occurs.</p> |
| <p>Cannot get IP address through wireless network.</p> | <p>Ensure that the USB wireless network adapter is plugged into the USB port on the top of the HHMPI, and ensure correct connection to the recorder. Connection is indicated by a white antennae icon found in the status bar of the display. See Section 3.5.4, "Network Settings" on page 18.</p> <p>Ensure wireless networking is enabled.</p> <p>If no link is detected an IP address has not been assigned to the HHMPI, this may be because of you network security settings. See your IT department or contact Flight Data Systems for more information if this occurs.</p> |
| <p>Cannot send files from the HHMPI to an FTP server via a wired network connection</p> | <p>Confirm the FTP settings are correct, see Section 5.0, "Configuring an FTP connection" on page 34.</p> <p>Ensure that an Ethernet cable is connected, and ensure correct connection to the recorder. Connection is indicated by a yellow network connection icon found in the status bar of the display. See Section 3.5.4, "Network Settings" on page 18.</p> <p>If no link is detected an IP address has not been assigned to the HHMPI, this may be because of you network security settings. See your IT department or contact Flight Data Systems for more information if this occurs.</p> |

Table 7.0 Troubleshooting common issues with the HHMPI

| Issue | Solution |
|---|--|
| Cannot send files from the HHMPI to an FTP server via a wireless network connection | <p>Confirm the FTP settings are correct, see Section 5.0, "Configuring an FTP connection" on page 34.</p> <p>Ensure that the USB wireless network adapter is plugged into the USB port on the top of the HHMPI, and ensure correct connection to the recorder. Connection is indicated by a white antennae icon found in the status bar of the display. See Section 3.5.4, "Network Settings" on page 18.</p> <p>Ensure wireless networking is enabled.</p> <p>If no link is detected an IP address has not been assigned to the HHMPI, this may be because of you network security settings. See your IT department or contact Flight Data Systems for more information if this occurs.</p> |
| Cannot copy files from HHMPI to PC using USB cable. | <p>Try another USB port.</p> <p>Check USB is working and that the PC is displaying the HHMPI as a mass storage device.</p> |
| Cannot load aircraft.csv file. | <p>Check the file in Notepad or Excel to see if it meets the format described in Section 4.2.2, "Creating an Aircraft List on a PC" on page 20.</p> <p>Try loading the file through the web interface, see Section 5.4.1, "Changing the HHMPI configuration via the web interface" on page 39.</p> |
| Cannot copy file from external memory device. | <p>Ensure that the external memory device is connected. Connection is indicated by an orange USB flash drive icon found in the status bar of the display.</p> <p>Check that the file is selected before attempting to copy the file. Check that the external memory device is not full.</p> |
| Cannot delete file from media storage device. | <p>Ensure that the external memory device is connected. Connection is indicated by an orange USB flash drive icon found in the status bar of the display.</p> <p>Check that the file is selected before attempting to delete the file.</p> |
| "UV" Displayed on screen. | <p>Battery under voltage, charge battery for an extended period (12 hours), if the fault message continues to be displayed, return the unit for repair.</p> |
| "Detected Battery Fault Condition" error message displayed on screen. | <p>Charge battery for an extended period (12 hours), if the fault message continues to be displayed, return the unit for repair.</p> |

Table 7.0 Troubleshooting common issues with the HHMPI

| Issue | Solution |
|------------------------------|---|
| "Unsupported Cable Detected" | <p>Ensure that the aircraft interface cable is correctly inserted.</p> <p>Ensure that the HHMPI is configured for the recorder, see System Information in Section 5.4.1, "Changing the HHMPI configuration via the web interface" on page 39.</p> <p>Check the aircraft interface cable for damage.</p> <p>Check the aircraft interface cable for any debris that could be causing connection issues.</p> |
| "Mount Error" | <p>Ensure that the external memory device is not corrupt or damaged in anyway.</p> <p>Ensure that the external memory device is correctly inserted in the HHMPI.</p> |

8.0 FA2100, FA2200 and FA2300 Interface Supplement

This supplement details the additional functions supported by the L-3 Aviation Recorders FA2100 CVFDR. For specific details on these recorders, refer to the appropriate L-3 FA2100 CVFDR OEM documentation.

8.1 Download Operations

The FA2100 supports the following download options:

- FDR All - Retrieves all flight data from the recorder.
- FDR Since Last - Retrieves only new flight data recorded since the last download operation was performed.
- FDR Time - Retrieves the last specified duration of flight data.
- FDR Mark - Retrieves all flight data newer than a specified memory mark.
- CVR All - Retrieves all cockpit voice recordings from the recorder. If CVR de-multiplexing is enabled on the HHMPI, recordings can also be decompressed so they can be played on a PC or other device.
- CVR Time - Retrieves the last specified duration of cockpit voice recordings.

See Section 4.3, "Downloading flight data" on page 23.

Table 8.0 File extensions of files downloaded from the FA2100

| Data Type | Extension |
|-------------|-----------|
| FDR | fdr |
| CVR | cvr |
| Fault Log | log |
| Debug Trace | log |

8.2 Recorder Operations

The FA2100 supports the following recorder operations:

- Monitoring of FDR Status.
- Monitoring of CVR Status.
- Setting of FDR and CVR memory markers.

- Clearing of latched faults and fault log.
- Download of CVFDR fault logs. See Figure 37.0, "FA2100 Recorder Operations - Dump Debug Trace", on page 49.

8.3 FDR Status

Indicates the status of the following:

- FDR Stream Detected
- Frame Lock
- Recorded Minutes
- Latched
- Fault

8.4 CVR Status

Indicates the status of the following:

- Latched
- Fault
- Recording

8.5 FDR or CVR Fault Output

The cockpit fault light can be forced on or off using the **left** and **right** buttons.

8.6 Clear Latched Fault

Sets or reset the fault log.

8.7 Clear Fault Log

Erases the fault log.

8.8 Dump Fault Log

Saves the fault log to selected memory. See Figure 37.0, "FA2100 Recorder Operations - Dump Debug Trace", on page 49.

Figure 37.0 FA2100 Recorder Operations - Dump Debug Trace



8.9 Dump Debug Trace

This function dumps the running debug stream from an L3 FA2100 recorder to a file on the HHMPI. This file is a text file readable in any text editor.

8.10 Memory Marker

Set a new FDR memory marker. The next marker will be chosen in the range 1-15, when all the markers are set, the marker count returns to 1.

8.11 Audio Operations

The FA5000/FA5001 audio can be both monitored in real time, and also play back previously recorded data. To listen to audio, plug headphones into the audio jack on the bottom of the HHMPI, see Figure 3.0, "HHMPI bottom view", on page 7.

Press the **up** and **down** buttons to select which channel you want to listen to. **Shortcut button 2** increases the volume and **shortcut button 3** decreases the volume. In playback mode, the **left** and **right** buttons rewind or fast forward the current playback position. See Figure 38.0, "CVR Live Audio volume control", on page 50.

Figure 38.0 CVR Live Audio volume control

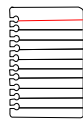

Note The CVFDR must be configured appropriately for playback, that is, not currently recording. Refer to the component maintenance manual for instructions.

8.12 Live Data View

Real time ARINC-717 data can be monitored from the FA2100. See Section 4.4, "Viewing live flight data" on page 26.

8.13 Menu Tree

The following menu items are enabled on connection to a FA5000/FA5001 recorder.

Table 9.0 Additional menu items for FA2100 CVFDR

| Main Menu | Menu Level 1 | Menu Level 2 |
|--|----------------|-------------------------------|
| Download Operations (Section 4.3, "Downloading flight data" on page 23) | FDR All | |
| | FDR Since Last | |
| | FDR Mark | |
| | FDR Time | |
| | CVR All | CVR Decompression (OK/Cancel) |
| | CVR Time | |

Table 9.0 Additional menu items for FA2100 CVFDR

| Main Menu | Menu Level 1 | Menu Level 2 |
|---|---------------------|---|
| Recorder Operations | FDR Status | <i>FDR Stream Detected Frame Lock Recorded Minutes Latched Fault</i> |
| | CVR Status | <i>Latched Fault Recording</i> |
| | FDR Fault Output | <i>Forced On/Off</i> |
| | CVR Fault Output | |
| | Clear Latched Fault | <i>Set/Reset</i> |
| | Clear Fault Log | |
| | Dump Fault Log | <i>Select memory</i> |
| | Dump Debug Trace | |
| | Memory Marker | <i>Set a memory marker (1-15)</i> |
| Audio Operations | CVR Live Audio | <i>Select Monitor Channel: HQV1, HQV2, HQV3, SQN, SQC, HQC. Audio volume Data Rate</i> |
| | CVR Playback | <i>Select Playback Channel: HQV1, HQV2, HQV3, SQN, SQC, HQC. Playback status Playback audio volume Playback data Rate</i> |
| Live Data View (Section 4.4, "Viewing live flight data" on page 26) | View Live Data | |

9.0 SRVIVR™ Interface Supplement

This supplement details the additional functions supported by the L-3 Aviation Recorders SRVIVR™ CVFDR. For specific details on these recorders, refer to the appropriate L-3 SRVIVR™ OEM documentation.

9.1 Download Operations

The SRVIVR™ supports the following download options:

- CVR All - Retrieves all cockpit voice recordings from the recorder.
- CVR Since Last - Retrieves only new cockpit voice recordings recorded since the last download operation was performed.
- CVR Last Flight - Retrieves only new cockpit voice recordings recorded since the last flight.
- CVR Time - Retrieves the last specified duration of flight data.
- DLR All - Retrieves all Datalink recordings from the recorder.
- DLR Since Last - Retrieves only new Datalink recordings recorded since the last download operation was performed.
- DLR Last Flight - Retrieves only new Datalink recordings recorded since the last flight.
- DLR Time - Retrieves the last specified duration of Datalink recordings.

- FDR All - Retrieves all flight data from the recorder.
- FDR Since Last - Retrieves only new flight data recorded since the last download operation was performed.
- FDR Last Flight - Retrieves only new flight data recorded since the last flight.
- FDR Time - Retrieves the last specified duration of flight data.
- BIT All - Retrieves all BIT data from the recorder for SRU fault isolation.
- BIT Since Last - Retrieves only new BIT data recorded since the last download operation was performed.
- BIT Last Flight - Retrieves only new BIT data recorded since the last flight.
- BIT Time - Retrieves the last specified duration of BIT data.

See Figure 39.0, “SRVIVR™ Download Operations”, on page 52 and Section 4.3, “Downloading flight data” on page 23.

Table 10.0 File extensions of files downloaded from the SRVIVR™

| Data Type | Extension |
|-----------|-----------------------|
| FDR | dfd |
| CVR | mic1, mic2, mic3, cam |
| DLR | dlk |

Figure 39.0 SRVIVR™ Download Operations



9.2 Recorder Operations

The SRVIVR™ supports the following recorder operations:

- Monitoring of CVFDR information, including system version, serial number etc. For full list of information, see Table 11.0, “Additional menu items for SRVIVR™ CVFDR,” on page 54 and Figure 40.0, “SRVIVR™ Recorder Operations - Information”, on page 53.
- Initiating system self test, see Figure 41.0, “SRVIVR™ Recorder Operations - Self Test”, on page 53.

Figure 40.0 SRVIVR™ Recorder Operations - Information



Figure 41.0 SRVIVR™ Recorder Operations - Self Test



9.3 Audio Operations

The SRVIVR™ audio can be monitored in real time. To listen to audio, plug headphones into the audio jack on the bottom of the HHMPI, see Figure 3.0, “HHMPI bottom view”, on page 7.

Press the **up** and **down** buttons to select which channel you want to listen to. **Shortcut button 2** increases the volume and **shortcut button 3** decreases the volume. See Figure 45.0, “CVR Live Audio volume control”, on page 58.

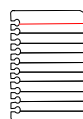

Note The CVFDR must be configured appropriately for playback, that is, not currently recording. Refer to the component maintenance manual for instructions.

9.4 Live Data View

Three streams of real time data can be monitored from the SRVIVR™:

- Live ARINC-717, see Section 4.4, “Viewing live flight data” on page 26.
- Monitoring of Captain’s Clock on the ARINC-429 GMT BUS, both labels 125 and 150.
- Monitoring of Rotor Frequency in Hz.

9.5 Menu Tree

The following menu items are enabled on connection to a SRVIVR™ recorder.

Table 11.0 Additional menu items for SRVIVR™ CVFDR

| Main Menu | Menu Level 1 | Menu Level 2 |
|--|-----------------|--|
| Download Operations (Section 4.3, "Downloading flight data" on page 23) | CVR All | |
| | CVR Since Last | |
| | CVR Last Flight | |
| | CVR Time | |
| | DLR All | |
| | DLR Since Last | |
| | DLR Last Flight | |
| | DLR Time | |
| | FDR All | |
| | FDR Since Last | |
| | FDR Last Flight | |
| | FDR Time | |
| | BIT All | |
| | BIT Since Last | |
| BIT Last Flight | | |
| BIT Time | | |
| Recorder Operations | Information | <i>System Version Serial Number Hardware Version Processor Version CPM Version Audio Version ARINC Version Boot Version OFP Version OFP CRC Config Data Version Config Data CRC Operating Hours Last Time Stamp CVFDR Mode Discrete Inputs Discrete Outputs CVR Status Word Processor Status Power Supply Status CPM Status Audio Status ARINC Status External Status</i> |
| | Self Test | <i>Processor Status Power Supply Status CPM Status Audio Status ARINC Status External Status</i> |

Table 11.0 Additional menu items for SRVIVR™ CVFDR

| Main Menu | Menu Level 1 | Menu Level 2 |
|--|---------------------|---|
| Audio Operations | CVR Live Audio | Select Monitor Channel: HQV1, HQV2, HQV3, SQN, SQC, HQC. Audio volume Data Rate |
| Live Data View (Section 4.4, "Viewing live flight data" on page 26). | View Live FDR Data | |
| | View DLR | DLR Heartbeat DLR Data |
| | View Captains Clock | Label 150 Clock (HH:MM:SS) Label 125 Clock (HH:MM:SS) |
| | View Rotor | Raw Rotor Frequency |

10.0 FA5000/FA5001 Interface Supplement

This supplement details the additional functions supported by the L-3 Aviation Recorders FA5000/FA5001 CVFDR. For specific details on these recorders, refer to the appropriate L-3 FA5000/FA5001 OEM documentation.

10.1 Download Operations

The FA5000/FA5001 supports the following download options:

- FDR All - Retrieves all flight data from the recorder.
- FDR Since Last - Retrieves only new flight data recorded since the last download operation was performed.
- FDR Time - Retrieves the last specified duration of flight data.
- FDR Mark - Retrieves all flight data newer than a specified memory mark.
- CVR All - Retrieves all cockpit voice recordings from the recorder.
- CVR Since Last - Retrieves only new cockpit voice recordings recorded since the last download operation was performed.
- CVR Time - Retrieves the last specified duration of cockpit voice recordings.
- CVR Mark - Retrieves all cockpit voice recordings newer than a specified memory mark.
- DLR All - Retrieves all Datalink recordings from the recorder.
- DLR Since Last - Retrieves only new Datalink recordings recorded since the last download operation was performed.
- DLR Mark - Retrieves all Datalink recordings newer than a specified memory mark.

See Figure 42.0, "FA5000/FA5001 Download Operations", on page 56 and Section 4.3, "Downloading flight data" on page 23.

- FDR All - Retrieves all flight data from the recorder.
- FDR Since Last - Retrieves only new flight data recorded since the last download operation was performed.
- FDR Time - Retrieves the last specified duration of flight data.
- FDR Mark - Retrieves all flight data newer than a specified memory mark.
- CVR All - Retrieves all cockpit voice recordings from the recorder.

- CVR Since Last - Retrieves only new cockpit voice recordings recorded since the last download operation was performed.
- CVR Time - Retrieves the last specified duration of cockpit voice recordings.
- CVR Mark - Retrieves all cockpit voice recordings newer than a specified memory mark.
- DLR All - Retrieves all Datalink recordings from the recorder.
- DLR Since Last - Retrieves only new Datalink recordings recorded since the last download operation was performed.
- DLR Mark - Retrieves all Datalink recordings newer than a specified memory mark.

Figure 42.0 FA5000/FA5001 Download Operations



10.2 Recorder Operations

The FA5000/FA5001 supports the following recorder operations:

- Monitoring of FDR Status. See Figure 43.0, "FA5000/FA5001 Recorder Operations - FDR Status", on page 57.
- Monitoring of CVR Status.
- Setting of FDR, CVR and DLR memory markers.
- Download of CVFDR fault logs. See Figure 44.0, "FA5000/FA5001 Recorder Operations - Dump Log", on page 57.
- Download EDS file. Get the ARINC 717 Engineering Documentation Standard (EDS) conversion file (FRCS, FRED, etc.) from the recorder.

Figure 43.0 FA5000/FA5001 Recorder Operations - FDR Status



Figure 44.0 FA5000/FA5001 Recorder Operations - Dump Log

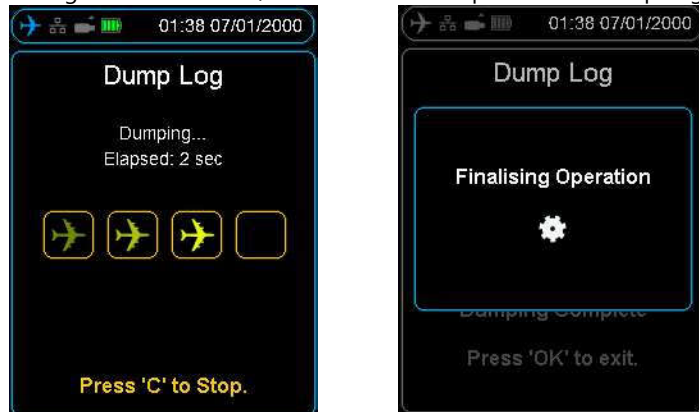

10.3 FDR Configuration

The FDR configuration menu details information about the recorder such as part numbers and version numbers.

10.4 Audio Operations

The FA5000/FA5001 audio can be both monitored in real time, and also play back previously recorded data. To listen to audio, plug headphones into the audio jack on the bottom of the HHMPI, see Figure 3.0, "HHMPI bottom view", on page 7.

Press the **up** and **down** buttons to select which channel you want to listen to. **Shortcut button 2** increases the volume and **shortcut button 3** decreases the volume. In playback mode, the **left** and **right** buttons rewind or fast forward the current playback position. See Figure 45.0, "CVR Live Audio volume control", on page 58.

Figure 45.0 CVR Live Audio volume control

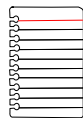

Note The CVFDR must be configured appropriately for playback, that is, not currently recording. Refer to the component maintenance manual for instructions.

10.5 Live Data View

Three streams of real time data can be monitored from the FA5000/FA5001:

- Live ARINC-717, see Section 4.4, "Viewing live flight data" on page 26.
- Monitoring of Captain's Clock on the ARINC-429 GMT BUS, both labels 125 and 150.
- Monitoring of Rotor Frequency in Hz.

10.6 Menu Tree

The following menu items are enabled on connection to a FA5000/FA5001 recorder.

Table 12.0 Additional menu items for FA5000/FA5001 CVFDR

| Main Menu | Menu Level 1 | Menu Level 2 |
|--|----------------|--------------|
| Download Operations (Section 4.3, "Downloading flight data" on page 23) | FDR All | |
| | FDR Since Last | |
| | FDR Time | |
| | FDR Mark | |
| | CVR All | |
| | CVR Since Last | |
| | CVR Time | |
| | CVR Mark | |
| | DLR All | |
| | DLR Since Last | |
| DLR Mark | | |

Table 12.0 Additional menu items for FA5000/FA5001 CVFDR

| Main Menu | Menu Level 1 | Menu Level 2 |
|---|---------------------|---|
| Recorder Operations | FDR Status | <i>FDR Fault FDR Input Data Lock ARINC 717 Data Received Current FDR Rate Latest FDR Marker</i> |
| | CVR Status | <i>CVR Fault Datalink Data Received GMT Data Received OMS Data Received Rotor Data Received CAM Audio Present and Sending Data MIC1 Audio Present and Sending Data MIC1 Audio Present and Sending Data MIC1 Audio Present and Sending Data Latest CVR Marker</i> |
| | Set FDR Marker | <i>Memory Marker - in progress or marker number</i> |
| | Set CVR Marker | <i>Memory Marker - in progress or marker number</i> |
| | Dump Log | <i>List of storage devices</i> |
| | Get EDS File | <i>List of storage devices</i> |
| FDR Configuration | Information | <i>Recorder Part Number Aircraft ID Recorder Serial Number Date(YYYY/MM/DD) Time(HH:MM:SS:MS) FW Version L3 HW FPGA Part Number L3 HW FPGA Part Number Revision L3 FW FPGA Part Number L3 FW FPGA Part Number Revision L3 FPGA FW Date (DD/MM/YYYY) PN Unknown1 PN Unknown2</i> |
| Audio Operations | CVR Live Audio | <i>Select Monitor Channel: HQV1, HQV2, HQV3, SQN, SQC, HQC. Audio volume Data Rate</i> |
| | CVR Playback | <i>Select Playback Channel: HQV1, HQV2, HQV3, SQN, SQC, HQC. Playback status Playback audio volume Playback data Rate</i> |
| Live Data View (Section 4.4, "Viewing live flight data" on page 26) | View Live Data | |
| | View Captains Clock | <i>Label 150 Clock (HH:MM:SS) Label 125 Clock (HH:MM:SS)</i> |
| | View Rotor | <i>Raw Rotor Frequency</i> |

11.0 SMITHS VADR Interface Supplement

This supplement details the additional functions supported by the Smiths VADR. For specific details on these recorders, refer to the appropriate Smiths VADR OEM documentation.

11.1 Select Aircraft

The Smiths VADR Select Aircraft menu is pre-installed with ARMY and RAAF models and registration information. See Figure 4.2.5, "Adding Entries to the HHMPI Aircraft File", on page 21 to add additional aircraft.

11.2 Download Operations

The Smiths VADR supports the following download options:

- FDR All - Retrieves all flight data from the recorder.
- CVR All - Retrieves all cockpit voice recordings from the recorder.

Table 13.0 File extensions of files downloaded from the Smiths VADR

| Data Type | Extension |
|-----------|-----------|
| FDR | .rdf |
| CVR | .rdf |

11.3 FDR Configuration

The FDR configuration menu details information such as aircraft serial number, version numbers (MP Software P/N and CP Software P/N), upload of Operational Flight Program (OFP) and settings for the aircraft tail number. See Figure 46.0, "VADR information", on page 60.

Figure 46.0 VADR information

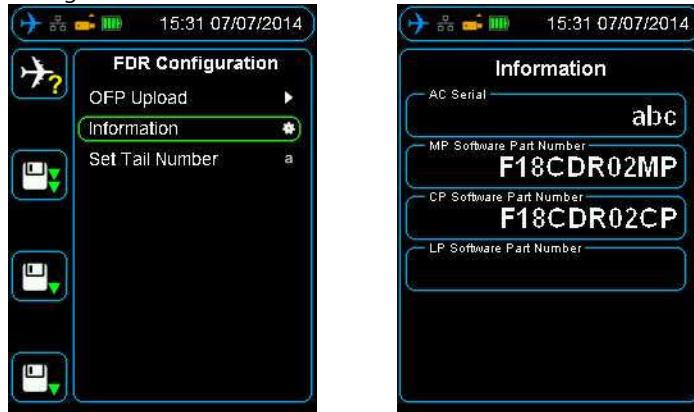

11.4 Upload OFP to the HHMPI

To upload OFP to the HHMPI:

1. Power up the HHMPI and connect to the VADR using a VADR aircraft interface cable.
2. Insert a USB flash drive into the USB port on top of the HHMPI containing the OFP files.
3. From the **Main** menu, press down until you reach the FDR Configuration command, and then press **right**.
4. Select OFT upload, and then select the .cpi file from the USB flash drive and confirm the selection by pressing the **OK** button.
5. Repeat step 4 for the .mpi file.

Once complete return to the FDR Configuration and confirm the files are loaded in the information section. See Figure 47.0, "Uploading OFP to the VADR from the HHMPI", on page 61.

Figure 47.0 Uploading OFP to the VADR from the HHMPI

