



www.avionteq.com

TIME DOMAIN REFLECTOMETRY (TDR) SYSTEM MANUAL

by

Steven R. Evett
USDA-ARS, P.O. Drawer 10
2300 Experiment Station Road
Bushland, TX 79012
srevett@bushlandars.com

This manual was prepared by a USDA employee as part of his official duties and cannot legally be copyrighted. The fact that the private publication in which the chapter may appear is itself copyrighted does not affect the material of the U.S. Government, which can be reproduced by the public at will.

The mention of trade or manufacturer names is made for information only and does not imply an endorsement, recommendation, or exclusion by USDA-Agricultural Research Service

The United States Department of Agriculture (USDA) prohibits discrimination in its programs on the basis of race, color, national origin, sex, religion, age, disability, political beliefs, and marital or familial status (Not all prohibited bases apply to all programs). Persons with disabilities who require alternative means for communication of program information (Braille, large print, audiotape, etc.) should contact the USDA's TARGET Center at 202-720-2600 (Voice and TDD). To file a complaint, write the Secretary of Agriculture, U.S. Department of Agriculture, Washington, DC 20250, or call 1-800-245-6340 (voice) or 202-720-1127 (TDD). USDA is an equal opportunity employer.

TABLE OF CONTENTS

| | |
|---------------------------------------------------------------------------------------------------------|------|
| 1 QUICK-START | 1-1 |
| 1.1 Time Domain Reflectometry (TDR) Systems | 1-3 |
| 1.2 Tektronix 1502B or 1502C cable testers, Reading Single Probes | 1-3 |
| 1.2.1 Set Up the Probe in Software Setup | 1-5 |
| 1.2.2 Position the Wave Form on the Screen and Save Position | 1-6 |
| 1.2.3 Connect a Probe and Make a Reading | 1-10 |
| 1.3 Dynamax Modified Tektronix 1502 Cable Tester | 1-11 |
| 1.4 Systems with One Multiplexer | 1-13 |
| 1.4.1 Connect Multiplexer | 1-13 |
| 1.4.2 Set Up Parallel Port | 1-13 |
| 1.4.3 Test Multiplexer and Connect Probes | 1-14 |
| 1.4.4 Set Up Multiplexer and Probe Connections in Software | 1-14 |
| 1.4.5 Set Up Individual Probe Distances and Wave Form Positions | 1-16 |
| 1.5 Systems with Several Multiplexers | 1-16 |
| 1.6 Manual and Automatic Readings | 1-23 |
| 2 DOCUMENTATION FOR TACQ.EXE | 2-1 |
| 2.1 Program Capabilities | 2-1 |
| 2.2 Hardware and Operating System Requirements | 2-1 |
| 2.3 Running TACQ Automatically | 2-3 |
| 2.4 Main Menu | 2-4 |
| 2.4.1 Software Setup | 2-4 |
| 2.4.1.1 Press T to choose a TDR instrument | 2-5 |
| 2.4.1.2 Press 1 to choose global defaults | 2-5 |
| 2.4.1.3 Press S to change serial port settings | 2-6 |
| 2.4.1.4 Press P to change parallel port settings & cable tester power control | 2-6 |
| 2.4.1.5 Press O to set up other data acquisition | 2-7 |
| 2.4.1.6 Press F to set files for automatic data acquisition | 2-8 |
| 2.4.1.7 Press W to set the write path | 2-8 |
| 2.4.1.8 Press A to set the automatic data acquisition interval | 2-8 |
| 2.4.1.9 Press D to set date and time | 2-9 |
| 2.4.1.10 Press M to set multiplexer and probe connections | 2-9 |
| 2.4.1.11 Press L to set cable lengths to probes, and individual probe Vp and DIST/DIV settings. | 2-9 |
| 2.4.1.12 Press I to change graphical interpretation methods | 2-10 |
| 2.4.2 Bring in a Wave Form | 2-10 |
| 2.4.3 File Functions | 2-11 |
| 2.4.3.1 Press A for automatic data acquisition mode | 2-11 |
| 2.4.3.2 Press S to acquire single wave forms | 2-11 |
| 2.4.3.3 Press T to enter test mode | 2-12 |
| 2.4.3.4 Press R to read in previously acquired wave forms | 2-12 |

| | | |
|-----------|-----------------------------------------------------------------------------|------------|
| 2.4.4 | Graph TDR Data | 2-13 |
| 2.4.5 | Control Multiplexers | 2-13 |
| 2.4.6 | Toggle Modified 1502 Cable Tester | 2-13 |
| 2.5 | Set Multiplexer and Probe Connections | 2-14 |
| 2.6 | Setting Cable Lengths, Vp and DIST/DIV | 2-21 |
| 2.7 | Algorithms for Reducing Wave Forms to Water Contents | 2-26 |
| 2.8 | File Formats | 2-30 |
| 2.8.1 | Automatically Collected Files | 2-30 |
| 2.8.2 | Manually Collected Files | 2-34 |
| 3 | CABLING | 3-1 |
| TR-1058 | Coaxial Extension Cable | 3-1 |
| TR-2000 | Modem Type Serial Cable | 3-3 |
| TR-2001 | Extended Length Serial Cable | 3-4 |
| TR-2002 | Serial Cable to Dynamax modified Tektronix 1502 | 3-4 |
| TR-2200 | Power and Multiplexer Control Cable | 3-6 |
| TR-2200 A | | 3-7 |
| TR-2200 B | | 3-7 |
| TR-2200 C | | 3-7 |
| TR-2201 | Cable Tester Power/Control Extension | 3-7 |
| TR-250 | Multiplexer Power/Control Extension | 3-8 |
| 4 | INSTALLING TDR PROBES and CABLES | 4-1 |
| 5 | TR-200 MULTIPLEXER | 5-1 |
| 6 | SOLAR POWER and POWER CONTROL | 6-1 |
| 6.1 | Power Requirements | 6-1 |
| 6.1.1 | Multiplexer Power Requirements | 6-1 |
| 6.1.2 | Computer and Cable Tester Power Requirements | 6-3 |
| 6.2 | Length of Data Acquisition Period | 6-3 |
| 6.3 | Power Available from the Sun | 6-4 |
| 6.4 | Power Available from a Solar Panel | 6-5 |
| 6.5 | Sizing a Solar Power System | 6-6 |
| 6.6 | Cable Tester Power Control with the TR-302 Power Control Module | 6-7 |
| 6.7 | Cable Tester Power Control with the TR-304 AC Power Control Module | 6-8 |
| 6.8 | Connect External 12 VDC Power to the 1502C TDR Cable Tester | 6-9 |
| 6.9 | Control 12 VDC Power to the 1502C TDR Cable Tester | 6-10 |
| 7 | PRINCIPLES and METHODS for TIME DOMAIN REFLECTOMETRY | 7-1 |
| 7.1 | Introduction | 7-1 |
| 7.2 | The TDR Method for Water Content Determination | 7-1 |
| 7.3 | Description of Wave Form Features as Related to the TDR Probe -Theory | 7-4 |
| 7.4 | Visual Wave Form Interpretation and Early Computer Programs | 7-6 |
| 7.5 | Factors Influencing Wave Form Shape | 7-7 |
| 7.5.1 | Dry Soil | 7-7 |
| 7.5.2 | Probe Design | 7-8 |

| | |
|--------------------------------------------------------------------------------|------|
| 7.5.3 Bulk Electrical Conductivity | 7-9 |
| 7.5.4 Equipment and Acquisition Method | 7-10 |
| 7.5.5 Cable Length | 7-11 |
| 7.6 Algorithms for Graphical Interpretation of Wave Forms | 7-12 |
| 7.6.1 Positioning of the Wave Form on the Screen | 7-12 |
| 7.6.2 Wave Form Smoothing | 7-15 |
| 7.6.3 Circumscribing Wave Form Interpretation | 7-15 |
| 7.6.4 Choosing Wave Form Interpretation Methods | 7-15 |
| 7.6.5 Finding Travel Times | 7-16 |
| 7.7 References | 7-18 |
| Appendix 7-A, Computer code for best combination of Vp and Dist/Div | 7-19 |
| | |
| 8 TEKTRONIX 1502 MODIFICATION for WAVEFORM OUTPUT | 8-1 |
| 8.1 Modifying the Tektronix 1502 for Digital Toggling of Waveform Output | 8-1 |
| 8.1.1 Parts List | 8-1 |
| 8.1.2 Relay Circuit Board | 8-2 |
| 8.1.3 Assembly | 8-3 |
| 8.1.4 Testing | 8-6 |
| 8.2 Digitizing the Waveform | 8-6 |
| 8.2.1 Using the Measurement Computing CI08 A/D Card | 8-6 |
| 8.2.2 Using the DATAQ Instruments Serial Data Acquisition Card | 8-7 |
| 8.2.2.1 Parts List | 8-7 |
| 8.2.2.2 Assembly with DATAQ Hardware | 8-8 |
| 8.2.2.3 Testing | 8-10 |

Readers with no understanding of the working principles of the time domain reflectometry (TDR) method of measuring soil water content should read Chapter 7, Principles and Methods for Time Domain Reflectometry, as soon as possible. Briefly, determination of water content with TDR relies on the fact that the travel time of an electromagnetic (EM) pulse through a stainless steel probe (the wave guide), embedded in the soil, is a function of the soil's water content. A schematic of a trifilar TDR probe and the corresponding wave form captured by a TDR cable tester indicates the points of correspondence between the physical parts of the probe (mainly the handle and the ends of the rods) and the inflections of the wave form (Fig. 1-1). The cable tester produces the EM pulse, and records and displays the wave form that results from reflections of the pulse from particular parts of the probe. The horizontal axis of the wave form, although displayed as distance on the cable tester, is actually measured in units of time. Therefore, the wave form can be interpreted manually or by software to find the travel time of the pulse along the exposed length of the probe rods. A calibration equation can be applied to the travel time data to find the water content. In Section 1 of this manual we explain how to set up a TDR system to capture the wave forms from individual probes, either manually or automatically and unattended. The system is controlled by the TACQ software (documented in Chapter 2) which also is capable of interpreting the wave form. The systems we will describe range from the most simple (a cable tester, computer, single TDR probe and software), to complex systems using several multiplexers and hundreds of probes (Fig. 1-2).

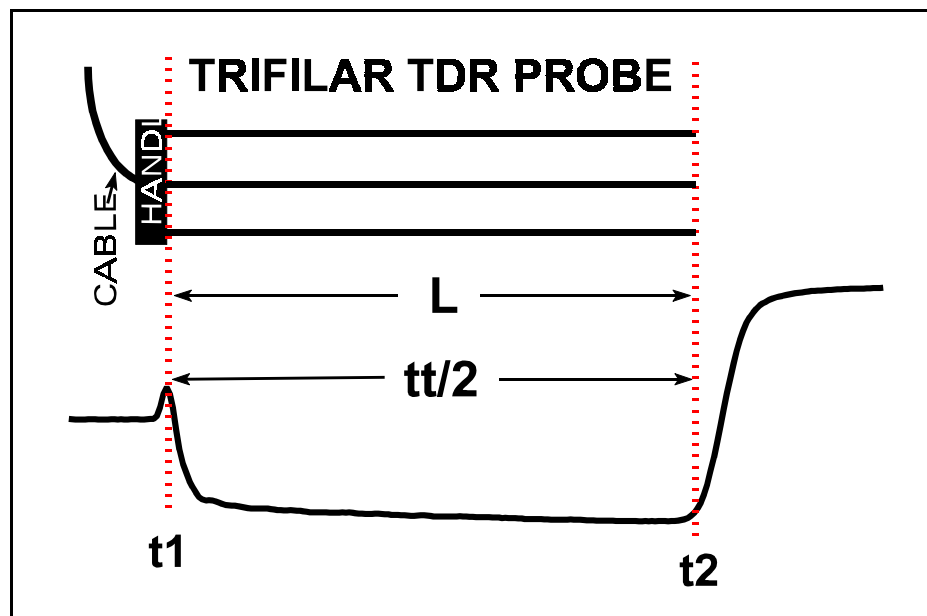

Figure 1-1 Relationship of TDR probe parts (top) to wave form features (bottom) for moist sand. For the wave form the vertical axis has units of voltage and the horizontal axis units of time.

The TDR probes, multiplexer, cables, and software discussed in this text were created by the author, and are now manufactured by Dynamax¹, Inc., Houston, Texas under a Cooperative Research and Development Agreement with USDA.

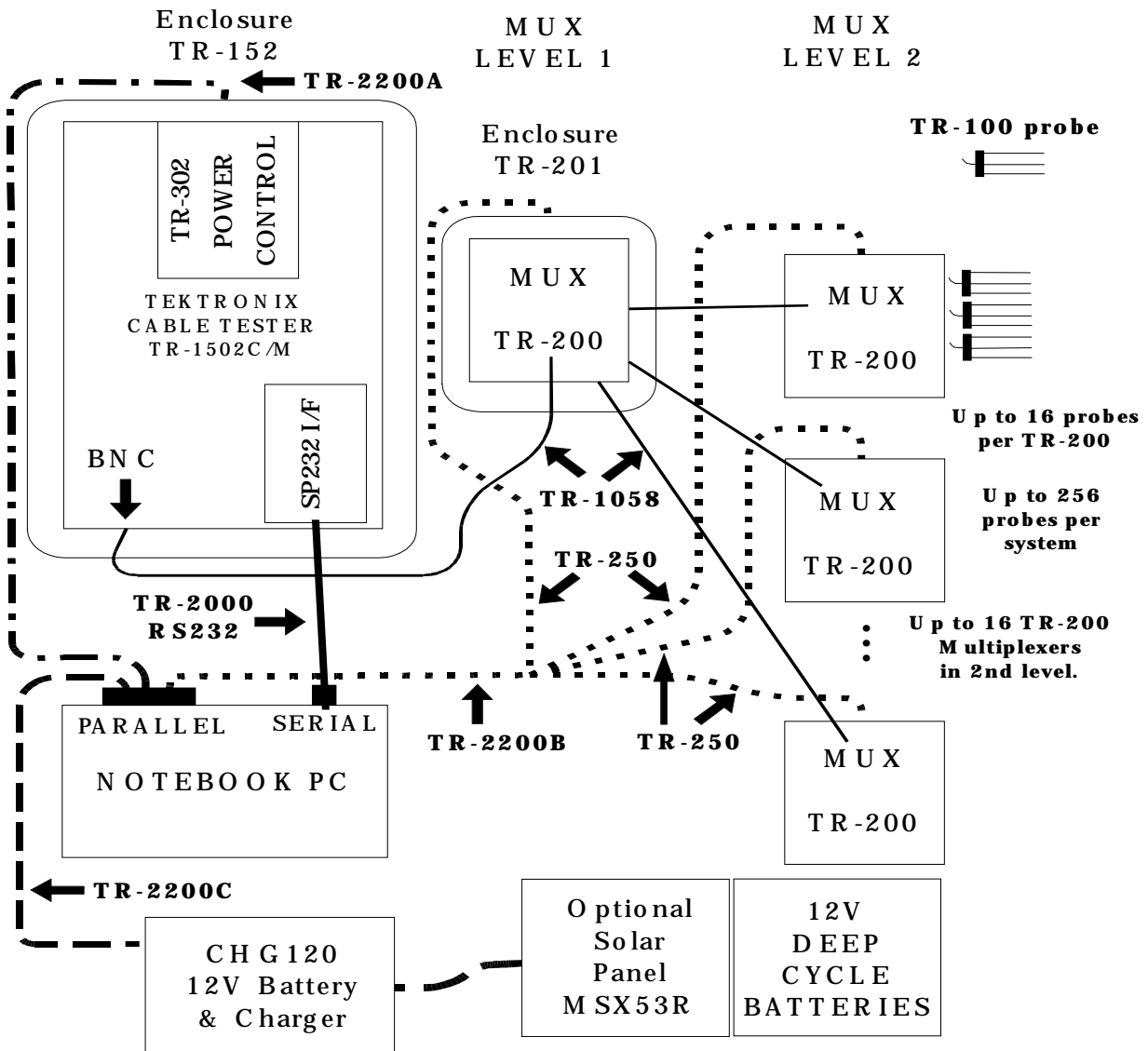

Figure 1-2. Prototypical TDR System Schematic. Model numbers for probes, cables, and the multiplexer are those assigned by the author, and may differ from numbers assigned by Dynamax, Inc.

¹The mention of trade or manufacturer names is made for information only and does not imply endorsement, recommendation, or exclusion by the USDA-Agricultural Research Service.

1.1 Time Domain Reflectometry (TDR) Systems

The most common minimal system consists of an IBM PC/AT compatible computer running the TACQ program, a Tektronix 1502B or 1502C cable tester equipped with a Tektronix SP232 serial extended function module, a serial cable to connect the two (TR-2001), and a single TDR probe (TR-100) connected to the BNC connector of the cable tester. The computer may be any PC/AT compatible with an RS-232 compatible serial port and Hercules, ATT (640 x 400 monochrome), EGA or VGA graphics. The operating system may be DOS or Windows (see Section 2.2 for special requirements for Windows setup). The serial cable should be a modem type (straight through connections) with a 25 pin D connector (male) for connection to the 1502B/C and either a 9 pin or 25 pin connector (female) as required to connect to the computer. Cable TR-2000 features a 9 pin connector that will plug into the serial port of most recent computers, and a 25 pin connector for the 1502B/C. See Section 3, Cabling, for cable specifications. Note that this system is equivalent to using one computer and cable tester to read many probes which are connected one at a time to the cable tester for data acquisition.

A second minimal system consists of the computer with operating system as specified above, and a TDR probe. But the computer is connected to a Tektronix 1502 cable tester that has been specially modified by Dynamax for serial digital output of the wave form (the 1502 normally outputs the wave form as an analog signal over a 20 s period). The computer and cable tester are connected using a special serial cable that has a 9 pin female connector that plugs into the computer's serial port and a round five pin connector that plugs into the Dynamax modified X-Y Output Module of the 1502.

Sections 1.2 and 1.3 describe setup and first use of these systems. Sections 1.4 and 1.5 describe more complex systems involving the use of multiplexers to read multiple probes (up to 256).

1.2 Tektronix 1502B or 1502C Cable Testers, Reading Single Probes

If not already installed, install the SP232 module into the cable tester following Tektronix's recommendations (turn off power by pushing in the power switch in the lower right corner of the cable tester front panel). Assure adequate power to the cable tester and computer either by charging the batteries or plugging the units into appropriate AC power outlets (see their manuals for instructions). Plug cable TR-2001 into the computer's serial port and into the 25 pin port of the SP232. Turn on power to the computer and cable tester. If the computer was purchased from Dynamax, the TACQ software will be pre-installed in directory C:\Dynamax. If not, then install the software by creating a subdirectory (your choice of name) on any drive with enough space to accommodate the TDR data files that will be created. The amount of space required may vary from a few hundred kilobytes for manual reading of a few probes to many megabytes for automatic unattended data acquisition from a multiplexing system involving many probes. See Section 2.8, File Formats, for more information. Install the software simply by copying the files TACQ.EXE, TACQ_TDR.INI and TACQ.INI to the subdirectory. You may also copy these files directly to the root directory, C:\, if you won't be bothered by the accumulation of data files there.

Run TACQ from the DOS prompt by typing TACQ and pressing the Enter key. The default setup of the program is for serial communication to the 1502B/C and the program will attempt to initialize communications at startup. You will see several messages on the screen as the subprogram FINDBAUD tests the serial ports and attempts to start communicating with the cable tester. If communication is successful then the main menu of TACQ will appear as shown in Fig. 1-3.

```
TACQ, Time Domain Reflectometry (TDR) System Control Program. USDA-ARS
2300 Experiment Station Road, Bushland, TX 79012. Beta 07-02-1997, 14:07:23
Location Suffix: TAC      Vp: .64, DIST/DIV: .1 m. Using LPT1.
Using Tektronix 1502B/1502C TDR cable tester (com1:19200,n,8,1)
```

```
Select from the following:
  Software Setup.
  File functions - Acquire & save to file, Read file
  Bring in a wave form.
  Graph TDR data.
  Control Vadose or SDMX-50 coaxial multiplexer.
  Control Tektronix 1502B/C TDR cable tester.
  Quit.
Enter your selection:
```

```
07-02-1997. 16:19:43. DOY: 183
```

Figure 1-3. Main Menu of program TACQ.

If you see this screen then skip to the next paragraph. If an error occurs in serial communications, a prompt will appear:

```
1502B/C not responding. Is it turned on? Is cable connected?
Try again, or quit [Y, N, or Q]:?
```

Check the cable connection and make sure the cable tester is turned on. If the cable tester was off, turn it on and wait 20 s for the cable tester to self-initialize before continuing. If either condition was incorrect then press Y to re-try. If the above prompt re-appears then press N and the Software Setup screen will appear (Fig. 1-4). There are several choices in Setup that may aid serial communications. If the cable tester shown is not correct then press C to change the cable tester, then use the up and down cursor keys to find the Tektronix 1502B/C choice, and press Enter to select it. Press S to change serial communications parameters. If you are using a very long serial cable then enter 1 for the delay for COMM port transmit/receive operations. You might also want to increase the wait for cable tester response from the default of 2. Setting the baud rate to a lower value may also allow serial communications under difficult conditions. If communications have failed, the COMM port will be set to COMM1 by default. Change this to the COMM port that you are using (usually 1 or 2). The program will again attempt to initialize serial communications. If the error persists, quit TACQ and verify that the serial port is working. Many laptop, notebook and subnotebook computers allow adjustment of serial port settings in CMOS setup. Check that the serial port is enabled and what port number it uses (COMM1, COMM2, etc.). Try running TACQ again.

```

                                SOFTWARE SETUP
Cable tester:      Tektronix 1502B/1502C TDR cable tester
Defaults          Vp: 0.64, DIST/DIV: .1 meters
                  Filter: No override.
Serial Port:      COM1:, 19200 baud, Send/Receive delay: 0, Wait: 3
Parallel Port:    LPT1:. Pins for TR-200: DATA 2, CLOCK 3, SDE 4
                  Pins for SDMX50: DATA 6, CLOCK 7, SDE 8
                  Delay between clock ticks is approx. .006 s.
                  Power Control Pin: 9
                  Continuous power to cable tester.
File Names:       Wave forms: 1997183T.TAC.  Water contents:
1997183W.TAC
                  Bulk electrical conductivity: 1997183E.TAC
Acquisition Interval: 1800 s.
Set Time/Date:    07-02-1997, 16:33:15
Multiplexer & Probe Connections:
Probe Cable Length, Vp, DIST/DIV:
Interpretation methods:
Press C, D, S, P, F, A, T, M, L, I or Esc:

```

Figure 1-4. Software setup screen of program TACQ.

1.2.1 Set Up the Probe in Software Setup.

At the Main Menu of TACQ press S to enter Software Setup. Even though there is no multiplexer we will use probe 1 on multiplexer 1 as a virtual, rather than physical, connection. This allows us to specify the distance to the probe and the Vp and DIST/DIV settings that give the correct wave form position and width on the screen; and have these settings saved so we don't have to enter them the next time that we want to acquire data. Press M to set up multiplexer and probe connections. The next screen shows all the multiplexers and the order in which they are connected:

```

Connection Setup
Multiplexer number, type [in brackets], and address.
No.[TYPE] Address
1[1] 1

Enter number corresponding to location in tree (Press <Enter> to exit):

```

Typically for a new installation there will be only one multiplexer shown; and the onscreen code will be 1[1]1 which indicates multiplexer 1, type 1 (Vadose TR-200), and address 1. Press 1 and then Enter to set up this multiplexer. A multiplexer type choice will be shown:

```

Choose 1 Vadose multiplexer, 2 CSI SDMX50 multiplexer
Enter number:

```

Press 1 (since no multiplexer is connected it doesn't matter what is entered here). Next, enter 1 for the multiplexer address and press Enter. The next screen shows the channels of the multiplexer (16 for the TR-200 and 8 for the SDMX50) and the status of connections to that multiplexer.

Channels connected to TDR probes are marked with pluses (+), channels connected to other multiplexers are marked with number of multiplexer. Working on multiplexer number & type: 1[1]. Navigate with cursor keys.

| Connection | Channel | Probe Length (m) | Acquire What? |
|------------|---------|------------------|---------------|
| | 1 | 0.2000 | ? |
| | 2 | 0.2000 | ? |
| | 3 | 0.2000 | ? |
| | 4 | 0.2000 | ? |
| | 5 | 0.2000 | ? |
| | 6 | 0.2000 | ? |
| | 7 | 0.2000 | ? |
| | 8 | 0.2000 | ? |
| | 9 | 0.2000 | ? |
| | 10 | 0.2000 | ? |
| | 11 | 0.2000 | ? |
| | 12 | 0.2000 | ? |
| | 13 | 0.2000 | ? |
| | 14 | 0.2000 | ? |
| | 15 | 0.2000 | ? |
| | 16 | 0.2000 | ? |

Toggle Probe connection on/off, Make/Break Multiplexer connection, or <Esc>.

Use the cursor keys to move the highlighted area from channel to channel and from column to column. There are three columns where information may be entered. Moving the highlighted area from column to column changes the prompt shown at the bottom of the screen. The left column is for changing connections. When the highlighted area is in the left column you may toggle a probe connection on or off by pressing P. Press P now and you will see a + sign appear for channel one. Moving the highlighted area to the Probe Length column (middle of screen) allows the probe lengths to be set for each probe. Enter a number here that is the exposed length of stainless steel rod. Moving the highlighted area to the right column allows the type of data collection to be set. Note that if N appears in this column for any channel there will be no data collected even if a probe connection is shown in the left column. When you have set up a probe connection for channel 1, entered the probe length, and chosen the data type as desired, press the Esc key. The next screen will show multiplexer connections (see beginning of this paragraph). Press Enter to exit multiplexer connection setup. A message about the number of probes in the system will be displayed. Press any key and the sequential order of probe acquisition will be displayed. In this example there is only one probe, so the order of acquisition cannot be changed. See Section 1.5 for information on changing the order of acquisition when more than one probe exists. Press Esc to return to the Software Setup screen.

1.2.2 Position the Wave Form on the Screen and Save Position

A probe (TR-100) must be connected to the cable tester in order to position the wave form. Connect a probe and put it in the porous medium to be measured. Press L to set the distance to the probe and position the wave form correctly on the screen. Ignore the brief message that states that multiplexer 1 is switching to channel 1. This is simply an indication that the software is recalling the probe length that we just set. The acquired wave form should appear in a screen similar to Fig. 1-5 (wave form shape may differ). Depending on the length of cable between cable tester and probe the wave form displayed may or may not include the section of interest (i.e., the reflections from the probe). For example, in Fig.

1-5 we see reflections from a 1 m long section of cable immediately after the BNC connector on the cable tester; the probe wave form is not shown (see Fig. 1-7 and 1-8 for examples of properly positioned wave forms). The wave form manipulation screen (Fig. 1-5) allows the user to adjust the cable tester in any way that could be accomplished by manual adjustment of knobs and buttons on the cable tester front panel. See Section 2.6; Setting Cable Lengths, Vp, Dist/Div; for more details of these adjustments. Briefly stated, the user may look at portions of the wave form that represent reflections from different distances from the cable tester. The current distances are displayed at the top of the graph. Pressing the F and B keys will move the window forward (longer distances) and backward, respectively, one window width at a time. Pressing H and then F or B, respectively, moves the window one half of its width in the respective direction. The user must adjust the view forwards or backwards until the wave form is properly positioned. An improperly positioned wave form cannot be correctly interpreted for water content determination by the software. Positioning is done by pressing the F, B, and H keys, or pressing E to enter a distance; by using the S key to fine tune the starting point (left hand side of the screen); and by changing the wave form width on the screen by changing the Vp and DIST/DIV settings. The first step is to find the part of the wave form that represents reflections from the TDR probe.

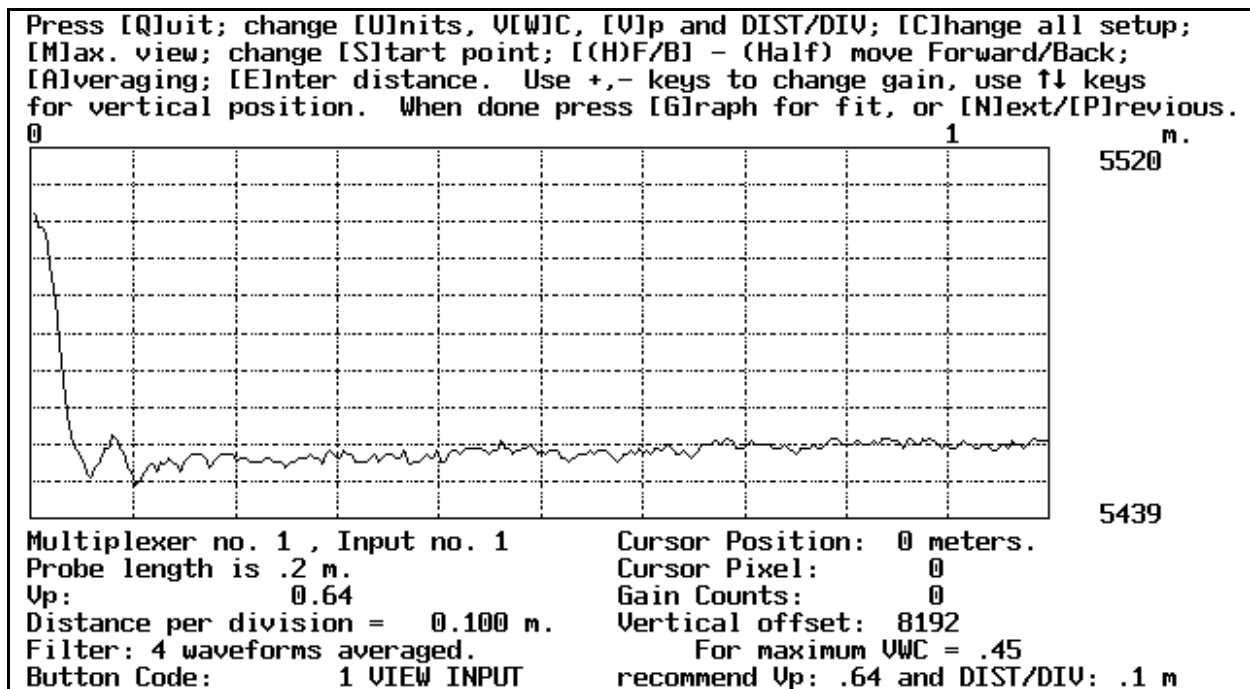

Figure 1-5. Wave form manipulation window before probe wave form is located. The Y-axis of this window automatically scales to display the data full screen. Wave forms will appear more noisy when there is a smaller magnitude between maximum and minimum Y-values.

The window width in length units (DIST/DIV), and the velocity of propagation, Vp, can be changed by pressing V. The Vp is the relative velocity of propagation (relative to the speed of light, c) that the cable tester uses to convert time to distance before displaying the data. Changing either the Vp or DIST/DIV values will change the horizontal width of the wave form shown on the screen. Note that the cable tester actually measures time, not distance, but it displays distance. The displayed distance will be correct only if the Vp setting is appropriate for the cable being used. This is because different cables

use different plastic insulating compounds between the inner conductor and outer conductor (shield) and the different permittivities of these compounds cause the TDR signal to travel faster (lower permittivity) or slower (higher permittivity). For most cables, a V_p setting of 0.66 will cause the distances calculated by the cable tester to be close to the actual distances along the cable. Changing V_p will affect the distances shown on the graph and it will change what is shown in the graph window. Using a smaller V_p will cause the apparent distance calculated by the cable tester to be smaller (distance = velocity x time) and features on the screen will become smaller in width. In effect, the window shows a longer actual view of reflections from the wave guide (this may include views of the wave guide inside the cable tester, in the cable between cable tester and probe, and/or the probe and beyond the probe).

The following procedure will place the wave form fairly close to the desired position. Press V and enter 0.66 followed by the Enter key. Then use the up and down cursor keys to select a DIST/DIV setting equal to the one recommended in the lower right corner of the screen. Measure the length of cable between the cable tester and the probe. Make sure that the units of your measured distance match those on the screen. Press E and enter the distance measured minus about 0.3 m or 1 ft (for Alpha RG58. For Belden RG58 use 0.1 m). The wave form should now include some of the reflections from the probe. Figure 1-6 shows a wave form for a 20 cm probe with a 3 m cable that was positioned using this procedure. Although this is not the desired position, it is close enough to allow fine tuning.

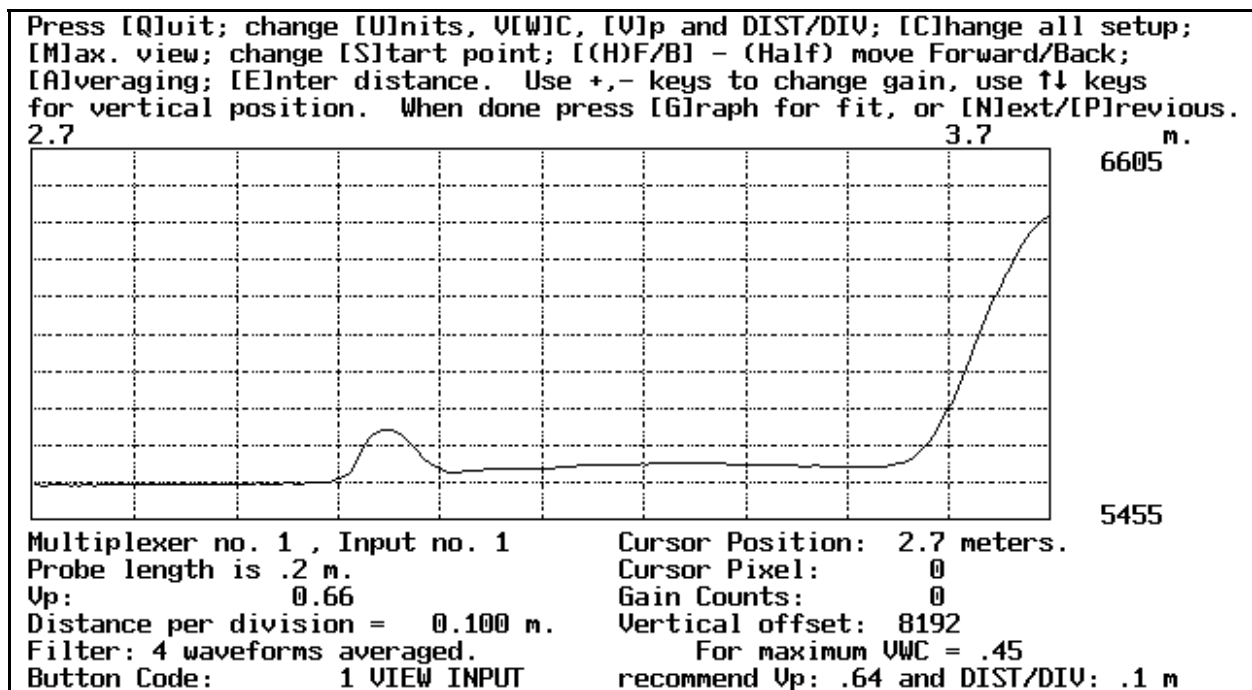

Figure 1-6. Wave form manipulation screen for probe on 3 m cable after first attempt to position wave form. Probe is in saturated sand.

Recommended V_p and DIST/DIV settings for the current probe length are given in the lower right corner of the screen. Enter these to adjust the wave form to the proper width (see Section 2.6 for further discussion of appropriate screen window width). Fine tune the position of the first peak by pressing S and moving the vertical line with the cursor keys. Pressing Esc will re-set the left hand border of the screen to the new position of the line. The desired position of the first peak is just to the right of

the first vertical grid mark (Fig. 1-7).

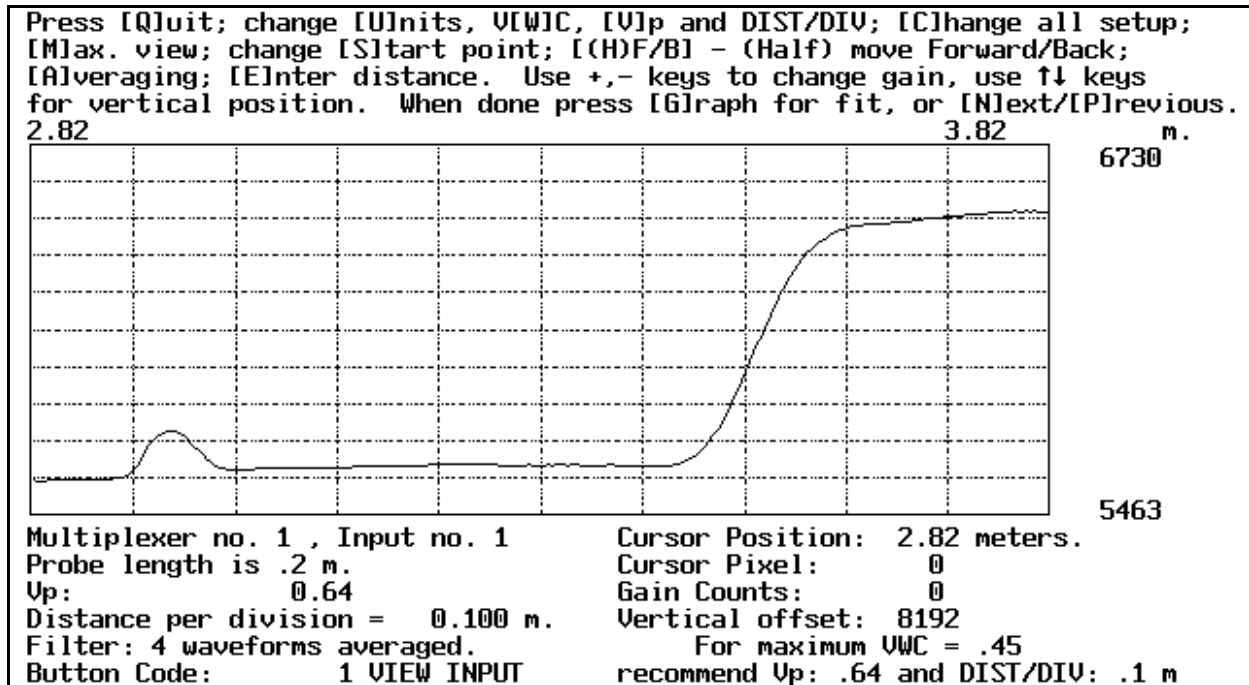

Figure 1-7. Wave form manipulation screen for probe on 3 m cable after adjusting the left hand border by pressing the S key and using the cursor keys. Probe is in saturated sand.

A typical wave form for a probe in dry sand is shown in Fig. 1-8. If the maximum volumetric water content (VWC) shown does not match your expected maximum or saturated water content then press W to change it. Then use the resulting new values of Vp and DIST/DIV. Once the wave form is properly positioned, press G if you want to see how the program will interpret the wave form for water content; or press N for the next probe. Since only one probe was set up in multiplexer and probe connections, this will end the probe position set up and the Software Setup main screen will appear. Press Esc to exit Software Setup, and make sure to save the set up. See Sections 2.4.1.10 and 2.7 for information on changing methods for wave form interpretation (finding of travel times and water contents), and Section 2 in general for information about saving data to files, automatic and unattended data acquisition, and acquisition of data for determination of bulk electrical conductivity. See Section 2.6, for more information on setting the distance to the probe, and setting Vp, and DIST/DIV settings to correctly position the wave form.

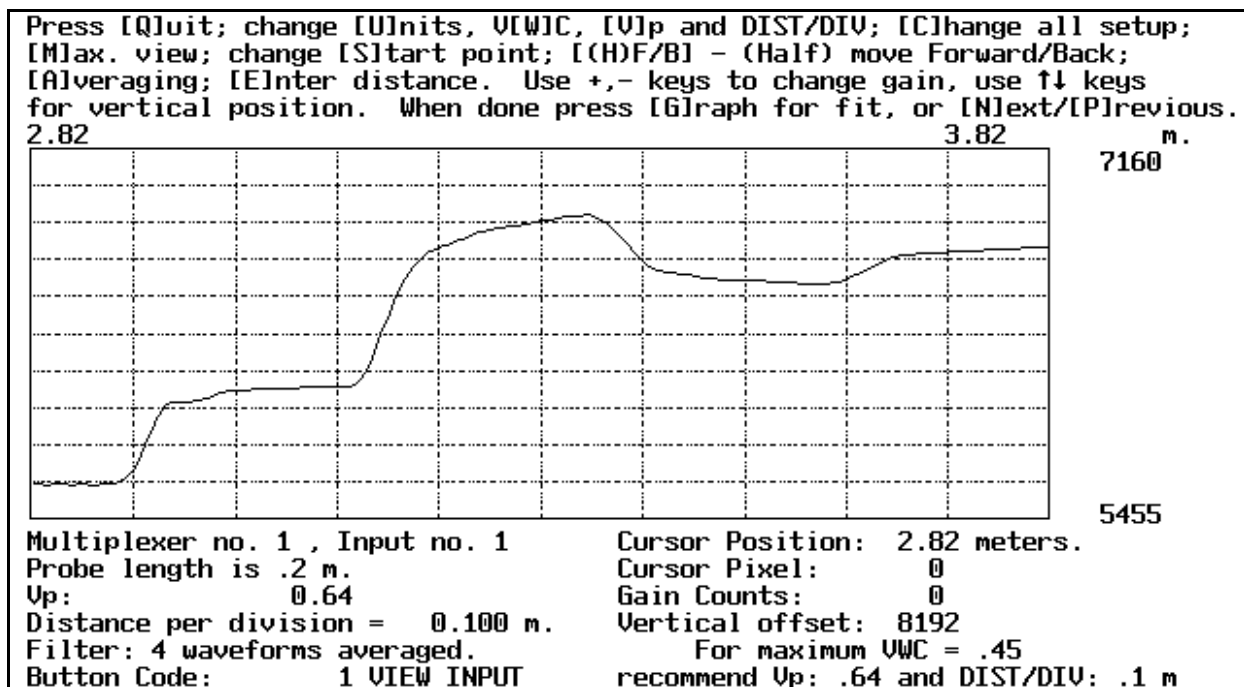

Figure 1-8. Wave form manipulation screen for probe on 3 m cable after adjusting the left hand border by pressing the S key and using the cursor keys. Probe is in air dry sand.

1.2.3 Connect a Probe and Make a Reading

With the probe in the soil (or other porous medium), from the main menu of TACQ (see Fig. 1-3), acquire a wave form and reduce it to water content by pressing F for File functions, and S to acquire a single wave form. Enter a file name or press Enter alone if you don't want to save the data. If a file name was entered, enter a comment when prompted, if desired, otherwise press Enter at the prompt. The comment serves to identify data from different probes if data from more than one probe is saved to the same file. Press Enter when prompted for a multiplexer number and again when prompted for a probe number; this causes the multiplexer number to be set to a default of one, and the probe number on the multiplexer to be set to a default of one. (This example assumes that no multiplexer is connected. Using the default values of one for multiplexer and probe causes the program to recall the probe length, cable length and wave form width information that we set up in Sections 1.2.1 and 1.2.2). Press Enter to accept the default probe length value (exposed length of rods) or enter a value and press Enter to correct the value if necessary. Brief messages will appear on the screen, stating that the multiplexer is switching (ignore this) and that data is being acquired. If the cable length and wave form position were properly set up and saved in Sections 1.2.1 and 1.2.2, then the acquired wave form should appear in a screen similar to Fig. 1-7 or 1-8 (wave form shape may differ).

Press G to graphically interpret the wave form for travel times and water content - the graphical interpretation screen will appear. Press Y to accept the interpretation and the data will be saved to disk. If BEC data were selected during probe connection setup then three additional wave forms will be captured for those data, with brief messages appearing on the screen for each. See Section 2 for more information on file names, formats, and specifying graphical interpretation methods. A prompt will appear asking if another wave form should be acquired. Wave forms from multiple individual probes may be acquired in this manner.

1.3 Dynamax Modified Tektronix 1502 Cable Tester

The Tektronix 1502 cable tester is a completely manually operated device without serial communications capability. When the toggle switch on the front panel is pressed, the 1502 will output a voltage on the Y output pins of the X-Y output module that is proportional to the voltage of the wave form. The output occurs over 20 s during which time a bright dot moves across the cable tester screen. During the 20 s period, the Y output voltage varies according to the height of the wave form at the point on the screen where the moving dot is. Dynamax will modify this cable tester by including a device to digitize the voltage and communicate the digital values to the computer over a serial cable. The modification includes a method of electronically toggling the cable tester to output the wave form voltage. A cable (TR-2002) is needed for connection between the computer (IBM PC/AT compatible with a serial port) and the modified cable tester. With the modification and cable, the TACQ program can toggle wave form output and read in the digitized wave form values through the serial port. See Sections 2.2 to 2.4 for more guidance on software installation, and computer and operating system compatibility. Note that the TACQ program cannot control the 1502 other than toggling wave form output. Adjustments of position of the wave form on the 1502 screen, DIST/DIV settings, relative velocity of propagation (Vp) settings (cable dielectric), gain, etc. can only be made by manual adjustment of the 1502.

Assure adequate power to the cable tester and computer either by charging the batteries or plugging them into appropriate AC lines (see their manuals for instructions). Plug cable TR-2002 into the computer's serial port and into the round 5 pin port of the X-Y Output module in the 1502. Turn on power to the computer and cable tester. If the computer was purchased from Dynamax, the TACQ software will be pre-installed in directory C:\Dynamax. If not, then install the software by creating a subdirectory (your choice of name) on any drive with enough space to accommodate the TDR data files that will be created. The amount of space required may vary from a few hundred kbytes for manual reading of a few probes to many megabytes for automatic unattended data acquisition from a multiplexing system involving many probes. See Section 2.8, File Formats, for more information. Install the software simply by copying the file TACQ.EXE, TACQ_TDR.INI and TACQ.INI to the subdirectory. You may also copy these files directly to C:\ if you won't be bothered by the accumulation of data files in the root directory.

Connect a probe (TR-100) to the cable tester using the BNC connector on the cable tester front panel. Place the probe in the soil (or other porous medium). Adjust the DISTANCE knob on the cable tester until the wave form is on the screen. Adjust the Vp and Distance per Division settings to show the wave form correctly on the screen. For Vp the default, as the modified 1502 is delivered, is 0.99. There are three push-button cable dielectric settings on the front panel. These set the Vp. The 0.99 value is for Air Dielectric - all three buttons should be in the out position. The DIST/DIV value is the product of the values to which the DIST and MULT knobs are set. The MULT knob has two positions: x1 and x.1. Settings that will work with 20 cm probes are Vp of 0.99, DIST of 5 feet, and MULT of x.1 (equivalent to DIST/DIV setting of 0.5 ft).

Run TACQ from the DOS prompt by typing TACQ and pressing the Enter key. The default setup of the program is for serial communication to the 1502B/C and the program will attempt to initialize communications at startup. Since the Dynamax modified 1502 has a different mode of serial communications, an error will occur in serial communications the first time TACQ is run. A prompt will appear:

```
1502B/C not responding. Is it turned on? Is cable connected?  
Try again, or quit [Y, N, or Q]:?
```

Press N and the following setup screen will appear.

```

                                SOFTWARE SETUP
Cable tester:      Tektronix 1502B/1502C TDR cable tester
Defaults          Vp: 0.64, DIST/DIV: .1 meters
                  Filter: No override.
Serial Port:      COM1:, 19200 baud, Send/Receive delay: 0, Wait: 3
Parallel Port:    LPT1:. Pins for TR-200: DATA 2, CLOCK 3, SDE 4
                  Pins for SDMX50: DATA 6, CLOCK 7, SDE 8
                  Delay between clock ticks is approx. .006 s.
                  Power Control Pin: 9
                  Continuous power to cable tester.
File Names:       Wave forms: 1997183T.TAC. Water contents:
1997183W.TAC
                  Bulk electrical conductivity: 1997183E.TAC
Acquisition Interval: 1800 s.
Set Time/Date:    07-02-1997, 16:33:15
Multiplexer & Probe Connections:
Probe Cable Length, Vp, DIST/DIV:
Interpretation methods:
Press C, D, S, P, F, A, T, M, L, I or Esc:
```

Figure 1-9. Software setup screen of program TACQ.

Make sure that the correct cable tester (Serial interface to Dynamax modified Tektronix 1502) is chosen. Press C and then the up and down arrow keys to find this choice and then press Enter to choose it.

Press D to change default cable tester values and enter the correct settings for Vp, for DIST/DIV units (feet or meters depending on Tektronix factory setup), and for the Distance per Division. See the cable tester front panel for these settings. The model 1502 cable testers were preset at the factory for units of either feet or meters. Enter the expected maximum or saturated water content, and the probe length when prompted. You will see two possible DIST/DIV choices with corresponding percent errors. The percent error is the difference between the screen width that would be obtained with the current Vp setting and possible DIST/DIV value and the optimum screen width. The error associated with the first DIST/DIV value will be negative or zero, indicating that the screen width would be smaller than optimum. The error for the second value will be positive or zero, indicating that the screen width would be larger than necessary. If the negative value is close to zero then the associated DIST/DIV value may work well. Otherwise, it would be preferable to use the second DIST/DIV value suggested. If neither error is close to zero, you may want to change Vp and see what other combinations may be available. There are three Vp settings that can be set using the pushbuttons on the 1502 front panel: Vp of 0.66 of solid POLY, Vp of 0.70 for solid PTFE, and Vp of 0.99 when all three buttons are out and the VAR screw is turned all the way clockwise. Advanced users may be able to use other Vp values by pushing OTHER and turning the VAR screw. However, this is difficult since the actual Vp setting is not known from the screw position.

Press S to change serial port settings. Enter zero for the transmit/receive delay unless the cable is longer than 2 m, in which case increase this setting until serial communications are stable. Accept the default value of 2 for the wait for cable tester response unless the cable is longer than 2 m in which case you may have to increase the time for stable serial communications. Enter a baud rate of 9600. Enter the number for the serial port to be used (usually 1 or 2). Accept the default settings for parallel

port and pins to be used. Even though a multiplexer is not attached, set up channel 1 of multiplexer 1 with a probe as discussed in Section 1.2.1. This will allow the program to remember the probe length. Exit the Setup screen, saving the setup in the process.

Re-try serial communications. If the error persists, quit TACQ and verify that the serial port is working. Many laptop, notebook and subnotebook computers allow adjustment of serial port settings in CMOS setup. Check that the serial port is enabled and what port number it uses (COMM1, COMM2, etc.). Try running TACQ again. Computers purchased from Dynamax come preconfigured for correct serial port communications.

Acquire the wave form and reduce it to water content by pressing B at the main menu of TACQ. Or, press F, and then S to acquire a water content and save the wave form as well. See Section 2, Documentation for TACQ.EXE, for information on changing methods for wave form interpretation (finding of travel times and water contents), saving data to files, file names and formats, and automatic and unattended data acquisition.

1.4 Systems With One Multiplexer

To connect the computer and cable tester and get the software working, read section 1.2 if you are using the Tektronix 1502B/C cable testers; or Section 1.3 if you are using the Dynamax modified Tektronix 1502.

1.4.1 Connect Multiplexer

The Vadose multiplexer (TR-200) requires 12 VDC power and is controlled by the computer through the parallel port via cable TR-2200B. The TR-2200 cable set features a 25 pin male connector for insertion into the computer's parallel port. Three cables run into this parallel port connector (see section 3, Cabling, for details of pin connections). One cable (TR-2200C) is a two conductor power cable with an automobile lighter adapter for connection to the necessary 12 VDC power supply. Power from this connection is routed through the 25 pin connector housing to the multiplexer - not to the computer. The automobile lighter adapter uses the standard polarity; the center conductor is +12 VDC and the outer shell is ground. A second cable (TR-2200A) is terminated in a three pin, polarized connector that may be plugged into the TR-302 battery power control module for a 1502 or 1502B/C cable tester (see section 6, Solar Power and Power Control, for details on controlling power to the cable tester). The present discussion assumes that power control is not used - it is usually needed only for solar powered systems. The third cable (TR-2200B) is terminated in a 5 pin, polarized connector that plugs into the multiplexer (Fig. 5-1). The multiplexer can be set to one of 16 addresses by moving a jumper on its back side (Fig. 5-2). The multiplexer should be marked with the factory set address. If the marking is no longer present, turn the multiplexer over (remove it from the TR-201 enclosure if necessary) and compare the jumper placement to the address numbers in Fig. 5-2 and note the address (placing a piece of tape on the front of the multiplexer and writing the address there works well). Place the multiplexer on a clean, dry, horizontal surface (or in an enclosure) and connect the cable. Plug the 25 pin connector into the computer's parallel port.

1.4.2 Set Up Parallel Port

At the main menu of TACQ press S for software setup, then press P for parallel port setup. If more than one parallel port is present, select the one to which the TR-2200 cable is connected. The next three prompts are for setting the parallel port pins used to control the multiplexer. For the TR-2200 cable

these must be set to 2, 3, and 4, in that order (see prompts). The next three prompts deal with parallel port pins used to control the Campbell Scientific, Inc. SDMX50 multiplexer. Press Enter three times to accept the defaults. At the prompt asking for the parallel port pin used to control power to the cable tester, press 9. Then, enter 2 to delay about 0.006 s between clock ticks for parallel port control. Next, enter zero for delay after power is turned on at the cable tester. This will keep the power on permanently if the cable tester is equipped with the TR-302 power control module. If you want the cable tester to be turned off between sets of readings then enter 5 or more seconds for the delay. Enter 5 for the pin used to signal an optional remote controlled AC power strip on and off. Enter zero to keep AC power on always, or enter 1 or more seconds for the delay to have the AC power turned off during data acquisition (sometimes reduces noise on the cable tester). Read Chapter 6, sections 6.6 through 6.9 for more information on options and equipment for power control. Read Chapter 2, section 2.4.1.4 for more information on parallel port settings.

1.4.3 Test Multiplexer and Connect Probes

Turn on the computer and start TACQ. Test the multiplexer as follows. At the main menu of TACQ press V to control the Vadose multiplexer. Press 1 and the Enter key to switch to channel 1; and then enter a number corresponding to the multiplexer address that you just determined, followed by the Enter key. Use a continuity meter or resistance meter (e.g., a digital multimeter) to measure the resistance between the center contact of BNC connector 1 of the multiplexer and the center contact of the BNC connector in the middle of the multiplexer (see Fig 5-1). The resistance shown should be near zero or zero. Next press V, followed by pressing 2 and then press the Enter key twice (you don't have to enter the multiplexer address again because the program remembers it). You should hear a click as the multiplexer relay switches from connector 1 to connector 2. Now, the resistance between the center pin of BNC connector 1 and the center pin of the middle BNC connector should be very high; and the resistance between the center pin of BNC connector 2 and the center pin of the middle BNC connector should be at or near zero. The other 14 channels may also be tested in this manner if desired.

Connect the central BNC connector of the multiplexer to the BNC connector on the cable tester front panel using 50 ohm coaxial cable TR-1058 or equivalent. Proceed to insert the TDR probes in the soil or other porous medium (see Section 4 for advice) and connect the probe coaxial cables to the multiplexer. It is usually best to connect the probes starting with input connector 1 on the multiplexer, then connector 2, etc. If there is a particular order in which you would like the probes to be sensed, connect them in that order. Note that if the older model 1502 cable tester is used (not the 1502B or 1502C models) then all cable lengths to probes must be equal.

1.4.4 Set Up Multiplexer and Probe Connections in Software

At the Software Setup screen, press M to set up multiplexer and probe connections. The next screen shows all the multiplexers and the order in which they are connected:

```
Multiplexer number, type [in brackets], and address.  
No.[TYPE] Address  
1[1] 1  
  
Enter number corresponding to location in tree (Press <Enter> to exit):
```

Typically for a new installation there will be only one multiplexer shown; and the onscreen code will be 1[1]1 which indicates multiplexer 1, type 1 (Vadose TR-200), and address 1. Press 1 and then Enter to set up this multiplexer. A multiplexer type choice will be shown:

Choose 1 Vadose multiplexer, 2 CSI SDMX50 multiplexer
Enter number:

Press 1 if it is a TR-200 or 2 if it is an SDMX50. Next, key in the multiplexer address and press Enter. The next screen shows the channels of the multiplexer (16 for the TR-200 and 8 for the SDMX50) and the status of connections to that multiplexer.

Channels connected to TDR probes are marked with pluses (+), channels connected to other multiplexers are marked with number of multiplexer. Working on multiplexer number & type: 1[1]. Navigate with cursor keys.

| Connection | Channel | Probe Length (m) | Acquire What? |
|------------|---------|------------------|---------------|
| | 1 | 0.2000 | ? |
| | 2 | 0.2000 | ? |
| | 3 | 0.2000 | ? |
| | 4 | 0.2000 | ? |
| | 5 | 0.2000 | ? |
| | 6 | 0.2000 | ? |
| | 7 | 0.2000 | ? |
| | 8 | 0.2000 | ? |
| | 9 | 0.2000 | ? |
| | 10 | 0.2000 | ? |
| | 11 | 0.2000 | ? |
| | 12 | 0.2000 | ? |
| | 13 | 0.2000 | ? |
| | 14 | 0.2000 | ? |
| | 15 | 0.2000 | ? |
| | 16 | 0.2000 | ? |

Toggle Probe connection on/off, Make/Break Multiplexer connection, or <Esc>.

Use the cursor keys to move the highlighted area from channel to channel and from column to column. There are three columns. Moving the highlighted area from column to column changes the prompt shown at the bottom of the screen. The left column is for changing connections. When the highlighted area is in the left column you may toggle a probe connection on or off by pressing P. A probe connection is enabled for a given channel if a + sign appears under Connection on the same row as that channel number. Typically, for a new system setup the column under Connection will be blank. You may also make or break a multiplexer connection to the channel by pressing the M key and following the prompts (see section 1.5, Several Multiplexers for more information). Note that making or breaking probe or multiplexer connections in software does not affect any physical connections. It is the user's responsibility to make sure that the connections indicated in the software setup reflect the physical connections that have been made, or will be, made. You may come back to these setup screens at any time to change probe and multiplexer connections. Moving the highlighted area to the Probe Length column (middle of screen) allows the probe lengths to be set for each probe. The number entered here should reflect the exposed length of stainless steel rod. Moving the highlighted area to the right column allows the type of data collected for each probe to be set. Note that if N appears in this column for any

channel there will be no data collected even if a probe connection is shown in the left column. When all probe connections, probe lengths and data collection choices are set as desired, press the Esc key. The next screen will be the screen showing multiplexer connections (see beginning of this paragraph). Press Enter to exit multiplexer connection setup and a screen detailing the number of probes assigned to the system will be displayed. Press any key and a screen displaying the sequential order of probe data acquisition will be displayed. You may re-arrange the order of acquisition, if desired, by following the prompts. Press Esc to return to the Software Setup main screen.

1.4.5 Set Up Individual Probe Distances and Wave Form Positions in Software

The next step is to set the distance to each probe and to position each probe's wave form correctly on the screen. These settings must be correct in order for the system to correctly find and interpret the wave form for each probe. In order for this part of software setup to proceed correctly, the physical connections that the user has indicated in software must in fact exist and the multiplexer must be properly connected to the computer and cable tester using cables TR-2200, TR-1058; and the TR-250 extension cable if needed. Press L at the Software Setup menu of TACQ. The screen will clear and briefly display a message indicating to which channel on which multiplexer the system is switching. The system automatically switches to the first probe on the first multiplexer. Make the distance, Vp, and Dist/Div setting changes needed for that probe (See Section 1.2.2, Position the Wave Form on the Screen and Save Position, for instructions on how to adjust the wave form to properly show the pulse reflections from the probe). When finished adjusting the wave form, press N to set the wave form for the next probe on the multiplexer; or, press G to see the graph of the present wave form with the tangent lines fitted for travel time and water content determination. Right now it is preferable to press N rather than G. After all the wave form positions are set up you can go back and look at the fitting. After the user presses N, the system switches to the next probe. The user may press P to return to the previous probe. The user repeats the wave form positioning process for the next wave form. If this is the first time that wave forms have been positioned, the program will use the position data from the previous wave form to position the next one. If all cable lengths are the same then this position will probably be correct and the user can simply press N after confirming that each wave form is correctly positioned. This continues until all connected probes (as chosen by the user in software Connection Setup) are set up for distance, Vp, and Dist/Div.

See Section 1.6 for information on reading all the probes automatically or at any given time, or to read any one probe at one time.

1.5 Systems with Several Multiplexers

The recommended connection scheme (topology) is shown in Fig. 1-2. Connect the second, third, fourth, etc. multiplexers (Mux Level 2) to the first one (Mux level 1) using TR-1058 coaxial extension cables. Plug one end of each cable into the central BNC connector of each multiplexer in Mux Level 2 (see Fig. 5-1). Plug the other end of each cable into one of the 16 BNC connectors on the edges of multiplexer 1. The best practice is to connect multiplexer 2 to channel 1 of multiplexer 1, multiplexer 3 to channel 2 of multiplexer 1, multiplexer 4 to channel 3 of multiplexer 1, etc. This is a tree topology rather than a daisy chain topology. Look at the jumper setting for each multiplexer (see Fig. 5-2) and note the address of each multiplexer. If any multiplexers share addresses, change the jumpers until all multiplexers have unique addresses. If 16 second-level multiplexers are used then two of these may have the same address. But, no second level multiplexer should have the same address as the first level

multiplexer. Use a separate length of TR-250 cable to connect each multiplexer to cable TR-2200(b) at a common connection point. This location should be in a weather tight enclosure, typically the one housing the computer and/or cable tester. At the common connection, wires of the same color should be soldered together; and insulated, either with electrical grade PVC tape or heat shrink tubing. See section 3, Cabling, for cable color codes and pin numbers for connection at the screw clamp connector of each multiplexer. At the other end of each TR-250, wires should be stripped about 6 mm from the end and tinned before clamping in the five pin connector. This connector is then plugged into the multiplexer. To set up the computer and cable tester, read section 1.1 and either section 1.2 or 1.3 as appropriate for the cable tester that is used.

A daisy chain topology is one in which multiplexer 2 is connected to multiplexer 1, multiplexer 3 is connected to multiplexer 2, multiplexer 4 is connected to multiplexer 3, etc. Daisy chaining should be avoided since the TDR signal must pass through many more relays and circuit boards before it reaches some probes as compared with the tree topology for which the signal passes through the same number of relays and circuit boards for all probes.

Note that if the model 1502 cable tester (not the 1502B or 1502C models) is used, then all cable lengths between the cable tester and probes must be equal. This is most easily assured by making sure that all TR-1058 coaxial extension cables, between second level multiplexers and the first level multiplexer, are equal in length; and, that the probe cables are all the same length.

Plug probe cables into the BNC connectors of the multiplexers as desired, usually proceeding from channel 1 to channel 2, etc. (the central connector of each multiplexer is not for probe connection but is for connection to another multiplexer or to the cable tester). For systems with many probes it is helpful to make a sketch showing the connections of multiplexers to each other and probes to multiplexers.

Run the TACQ software and press S to get into the Software Setup menu, then press M for multiplexer and probe connections. The first multiplexer setup screen is shown:

```
Connection Setup
Multiplexer number, type [in brackets], and address.
No.[TYPE] Address
1[1] 1

Enter number corresponding to location in tree (Press <Enter> to exit):
```

Typically, for a new setup, only one multiplexer will be shown, as is shown above. Press 1 and Enter and a multiplexer type choice will be presented:

```
Choose 1 Vadose multiplexer, 2 CSI SDMX50 multiplexer
Enter number:
```

Press 1 to select the Vadose multiplexer and a multiplexer address choice will be presented. Enter the address of multiplexer number 1, i.e. the address of the single multiplexer at MUX level 1. The next screen allows setting of connections for each channel on multiplexer 1. Note that there are no plus signs below 'Connection' in the example above. This indicates that no probes have been assigned to any of the channels. This is typical for a new system setup.

Channels connected to TDR probes are marked with pluses (+), channels connected to other multiplexers are marked with number of multiplexer. Working on multiplexer number & type: 1[1]. Navigate with cursor keys.

| Connection | Channel | Probe Length (m) | Acquire What? |
|------------|---------|------------------|---------------|
| | 1 | 0.2000 | ? |
| | 2 | 0.2000 | ? |
| | 3 | 0.2000 | ? |
| | 4 | 0.2000 | ? |
| | 5 | 0.2000 | ? |
| | 6 | 0.2000 | ? |
| | 7 | 0.2000 | ? |
| | 8 | 0.2000 | ? |
| | 9 | 0.2000 | ? |
| | 10 | 0.2000 | ? |
| | 11 | 0.2000 | ? |
| | 12 | 0.2000 | ? |
| | 13 | 0.2000 | ? |
| | 14 | 0.2000 | ? |
| | 15 | 0.2000 | ? |
| | 16 | 0.2000 | ? |

Toggle Probe connection on/off, Make/Break Multiplexer connection, or <Esc>.

Also, no numbers appear below 'Connection' indicating that no multiplexer connections have been assigned. Under 'Probe Length' the number 0.2000 appears for all 16 channels. Under 'Acquire What?' there is a question mark for each channel indicating that the desired type of data acquisition has not been set. The position of the highlighted area indicates which property (Connection, Probe Length, or Acquire What?) can be set and for which channel. The default position of the highlighted area is under 'Connection' for channel 1. Use the cursor keys to move the highlighted area across and up and down the screen. Note that the prompt at the bottom of the screen changes to reflect the kind of input that is needed from the user for each column. Under 'Connection' the user can indicate a probe connection or disconnection, respectively, by pressing P to make a plus sign appear or disappear for each channel. Also the user can press M to make or break a multiplexer connection. Under 'Probe Length' the user should change the assigned probe length to reflect the actual length of the probe connected to each channel. Under 'Acquire What?' the user should press W to acquire only water contents (and wave forms), press E to acquire only data (relative wave form levels) for calculation of bulk electrical conductivity, or press B to acquire both kinds of data. Also, the user can press N to acquire no data for a particular probe.

Position the highlighted area under 'Connection' and on the channel to which multiplexer 2 is connected. This is the first multiplexer in MUX level 2 that is connected to multiplexer 1. Typically, multiplexer 2 will be connected to channel 1 of multiplexer 1. Press M and then C to set up the connection in software. Press 1 to indicate a Vadose multiplexer is connected and then enter the address of the multiplexer. The screen below will appear indicating that a multiplexer is connected to multiplexer 1 (in this case to channel 1). Note also that the word Multiplexer appears under 'Acquire What?'. The number 2 under 'Connection' indicates that the connected multiplexer is the second multiplexer or multiplexer 2. The number has nothing to do with the address of multiplexer 2 which may be any address except for the address of multiplexer 1.

Channels connected to TDR probes are marked with pluses (+), channels connected to other multiplexers are marked with number of multiplexer. Working on multiplexer number & type: 1[1]. Navigate with cursor keys.

| Connection | Channel | Probe Length (m) | Acquire What? |
|------------|---------|------------------|---------------|
| 2 | 1 | 0.2000 | Multiplexer |
| | 2 | 0.2000 | ? |
| | 3 | 0.2000 | ? |
| | 4 | 0.2000 | ? |
| | 5 | 0.2000 | ? |
| | 6 | 0.2000 | ? |
| | 7 | 0.2000 | ? |
| | 8 | 0.2000 | ? |
| | 9 | 0.2000 | ? |
| | 10 | 0.2000 | ? |
| | 11 | 0.2000 | ? |
| | 12 | 0.2000 | ? |
| | 13 | 0.2000 | ? |
| | 14 | 0.2000 | ? |
| | 15 | 0.2000 | ? |
| | 16 | 0.2000 | ? |

Toggle Probe connection on/off, Make/Break Multiplexer connection, or <Esc>.

Now move the highlighted area to channel 2 (assuming that this is where the third multiplexer is connected) and repeat the process of making a connection in software resulting in a screen like:

Channels connected to TDR probes are marked with pluses (+), channels connected to other multiplexers are marked with number of multiplexer. Working on multiplexer number & type: 1[1]. Navigate with cursor keys.

| Connection | Channel | Probe Length (m) | Acquire What? |
|------------|---------|------------------|---------------|
| 2 | 1 | 0.2000 | Multiplexer |
| 3 | 2 | 0.2000 | Multiplexer |
| | 3 | 0.2000 | ? |
| | 4 | 0.2000 | ? |
| | 5 | 0.2000 | ? |
| | 6 | 0.2000 | ? |
| | 7 | 0.2000 | ? |
| | 8 | 0.2000 | ? |
| | 9 | 0.2000 | ? |
| | 10 | 0.2000 | ? |
| | 11 | 0.2000 | ? |
| | 12 | 0.2000 | ? |
| | 13 | 0.2000 | ? |
| | 14 | 0.2000 | ? |
| | 15 | 0.2000 | ? |
| | 16 | 0.2000 | ? |

Toggle Probe connection on/off, Make/Break Multiplexer connection, or <Esc>.

Repeat this process until all the multiplexers that are physically connected to multiplexer 1 (or that will be physically connected) are shown as connected in software as well. When finished press the Esc key.

```

Connection Setup
Multiplexer number, type [in brackets], and address.
No.[TYPE] Address
1[1] 1
  2[1] 2
  3[1] 3

Enter number corresponding to location in tree (Press <Enter> to exit):

```

Assuming that two multiplexers were connected to multiplexer 1 the next screen will be: This screen also assumes that the addresses of the three multiplexers were 1, 2, and 3 for multiplexer 1 (MUX level 1) and multiplexers 2 and 3 (MUX level 2), respectively.

Now the probe connections to multiplexers 2 and 3 should be set up. Press 2 to see the connection setup screen for multiplexer 2 (below). Move the highlighted area with the cursor keys and press P until a plus sign appears for every channel to which a probe is physically connected. Move to the 'Probe Length' column and enter the actual probe length for each connected probe. Finally, move to the 'Acquire What?' column and make entries indicating the desired type of data acquisition for each probe. The following figure shows the setup for multiplexer 2 when 12 probes, each 20-cm long, have been set up on the first 12 channels. Water content has been chosen as output.

```

Channels connected to TDR probes are marked with pluses (+), channels
connected to other multiplexers are marked with number of multiplexer.
Working on multiplexer number & type: 2[1]. Navigate with cursor keys.

```

| Connection | Channel | Probe Length (m) | Acquire What? |
|------------|---------|------------------|---------------|
| + | 1 | 0.2000 | W |
| + | 2 | 0.2000 | W |
| + | 3 | 0.2000 | W |
| + | 4 | 0.2000 | W |
| + | 5 | 0.2000 | W |
| + | 6 | 0.2000 | W |
| + | 7 | 0.2000 | W |
| + | 8 | 0.2000 | W |
| + | 9 | 0.2000 | W |
| + | 10 | 0.2000 | W |
| + | 11 | 0.2000 | W |
| + | 12 | 0.2000 | W |
| | 13 | 0.2000 | ? |
| | 14 | 0.2000 | ? |
| | 15 | 0.2000 | ? |
| | 16 | 0.2000 | ? |

```

Acquire Water content or Bulk EC or Both or Neither, or <Esc>.

```

Press Esc when through setting up the probe connections for multiplexer 2 and the Connection Setup screen will appear again. Now press 3 to set up the probe connections, lengths and types of data acquisition that reflect the physical connections that have been or will be made to multiplexer 3.

Channels connected to TDR probes are marked with pluses (+), channels connected to other multiplexers are marked with number of multiplexer. Working on multiplexer number & type: 3[1]. Navigate with cursor keys.

| Connection | Channel | Probe Length (m) | Acquire What? |
|------------|---------|------------------|---------------|
| + | 1 | 0.2000 | W |
| + | 2 | 0.2000 | W |
| + | 3 | 0.2000 | W |
| + | 4 | 0.2000 | W |
| + | 5 | 0.2000 | W |
| + | 6 | 0.2000 | W |
| + | 7 | 0.2000 | W |
| + | 8 | 0.2000 | W |
| | 9 | 0.2000 | ? |
| | 10 | 0.2000 | ? |
| | 11 | 0.2000 | ? |
| | 12 | 0.2000 | ? |
| | 13 | 0.2000 | ? |
| | 14 | 0.2000 | ? |
| | 15 | 0.2000 | ? |
| | 16 | 0.2000 | ? |

Acquire Water content or Bulk EC or Both or Neither, or <Esc>.

The figure above shows the screen when 8 probes, each 20-cm long, have been set up for the first 8 channels of multiplexer 3. Repeat this process to set up probe connections for every multiplexer that has been connected to multiplexer 1. In this example, there are 3 multiplexers, and only multiplexers 2 and 3 have probes connected to them.

When finished assigning multiplexers and probes, press Enter at the Connection Setup screen. A screen similar to the following will be displayed. In this example, the previous setup (not shown) had 5 probes assigned to multiplexer 1 and there were no other multiplexers. The current setup has 2 more multiplexers and no probes assigned to multiplexer 1 so there were no probes in common between the old and new setups.

```

There were 5 probes in the system before changes.
There are 20 probes in the new system.
Looking at old probe list...
There were 0 probes common to new and old lists.
Looking at new probe list...
Number of probes in old list: 5
There were 20 new probes.
These will be added to the end of the acquisition list.
Press any key to continue ...

```

Pressing any key will display the following screen which shows the default sequential order of acquisition of data from the probes in the system.

Sequential acquisition order:

```
1> mux 2, chan. 1
2> mux 2, chan. 2
3> mux 2, chan. 3
4> mux 2, chan. 4
5> mux 2, chan. 5
6> mux 2, chan. 6
7> mux 2, chan. 7
8> mux 2, chan. 8
9> mux 2, chan. 9
10> mux 2, chan. 10
11> mux 2, chan. 11
12> mux 2, chan. 12
13> mux 3, chan. 1
14> mux 3, chan. 2
15> mux 3, chan. 3
16> mux 3, chan. 4
17> mux 3, chan. 5
18> mux 3, chan. 6
19> mux 3, chan. 7
20> mux 3, chan. 8
```

```
Re-arrange acquisition order of probes:
[M]ove one probe at a time;
[S]ort by mux #, and channel # on mux;
Sort by [R]ecursive search (TACQ default);
<Esc> to exit:
```

Press [M] to move; then use <Pg-Up/Pg-Dn/!!>. Press <Enter> to end move.

You may follow the prompts and move individual probes to different places in the order of acquisition. Or, you may automatically sort the probes in one of two ways. One sort ranks the probes by multiplexer number and then by channel number on each multiplexer. The other sort is the result of a recursive search of the multiplexer and probe setup. The recursive search order is that used by TACQ prior to the July, 1997 release. If many new probes have been added to ones previously assigned to the system, you may want to press S or R to sort them rather than moving them individually. Press Esc when finished arranging the order of acquisition and the Software Setup menu will appear.

If a Tektronix 1502B or 1502C cable tester is being used, pressing L at the Software Setup menu allows the user to set in software the distance to each probe individually; and to set the Vp and DIST/DIV settings for each probe to the optimal settings for data acquisition given that probe's length. These settings must be made in order for the system to correctly find the wave form for each probe. In order for this part of software setup to proceed correctly, the physical connections that the user has indicated in software must in fact exist and the multiplexers must be properly connected to power and switching signals using cables TR-2200 and TR-250; and to each other and the cable tester using coaxial cables TR-1058. After L is pressed the screen will clear and briefly display a message indicating to which probe on which multiplexer the system is switching. The system automatically switches to the first probe on the first second level multiplexer (multiplexer 2) that is connected to multiplexer 1. The wave form is acquired and graphed on the Wave Form Manipulation Screen. Make the distance, Vp, and Dist/Div setting changes needed for that probe (See Section 1.2.2, Position the Wave Form on the Screen and Save Position, for instructions on how to adjust the wave form to properly show the pulse reflections from the probe). When finished adjusting the wave form, press N to see the wave form for the next probe on multiplexer 2; or, press G to see the graph of the present wave form with the tangent lines fitted for water content determination. Right now it is preferable to press N rather than G. After all the wave form positions are set up you can go back and look at the fitting. After the user presses N, the system switches

to the next probe on multiplexer 2. This continues until all connected probes (as chosen by the user in software Connection Setup) are set up. The software then switches to the next multiplexer (multiplexer 3) connected to multiplexer 1 and allows set up for the first probe on that multiplexer, then the second probe, etc. This process continues until all probes that were indicated as connected in Connection Setup have been set up for distance, Vp, and Dist/Div. If you want to go back to a previous probe, simply press P at the Wave Form Manipulation Screen.

1.6 Manual and Automatic Readings

Manual readings from a single probe or multiplexed probes may be made at any time. The instructions given here assume that the system has been properly set up as described in the previous sections. To read a single probe press F at the main menu, followed by S. Enter a file name if you want to store the data to file. If you entered a file name you may also enter a comment at a subsequent prompt. Enter the multiplexer number and then the number of the probe on that multiplexer in succeeding prompts (these will be 1 and 1 if a single probe is connected directly to the cable tester). Accept or change the probe length as desired. When the wave form manipulation screen is displayed, the wave form should be properly positioned - if not then position it here (see Section 1.2.2). Press G to interpret the wave form for water content. After wave form interpretation, press Y to accept the wave form. If a file name was given, data will be saved.

There are three ways to read all probes in a multiplexed system. The first way is to press F at the main menu, followed by A for automatic. When the automatic acquisition screen is displayed you wait for the next acquisition interval as displayed on the screen, or you may read the probes manually by pressing T for test. Note that to use automatic acquisition you should input an acquisition interval in Software Setup. The second way is to press F at the main menu followed by T; which again allows you to read all probes in test mode. The program prompts the user for a file name prefix (up to 8 characters) that will be used to name the output files (see Sections 2.4.3.2 and 2.8 for a description of how the data will be saved). Acquiring data in test mode is slower because the wave form is displayed twice, once for the wave form manipulation screen, and again for the wave form interpretation screen. Also, key presses from the user are required to move from screen to screen, and to accept each wave form. The third way to acquire data from all probes is to type TACQ AUTOSTOP on the DOS command line, followed by pressing Enter (there is a space between TACQ and AUTOSTOP). This will cause TACQ to immediately acquire all the data automatically and without user intervention. The only drawback is that the file names that will be used are the default file names for automatic data acquisition. The user may get around this by first running TACQ and changing the file name suffix in Software Setup; then running TACQ from the command line with TACQ AUTOSTOP; and then re-running TACQ and setting the file name suffix back to its original setting.

Set the acquisition interval in the Software Setup menu before automatic readings are made. Then, at the main menu, press F, then A and wait for automatic acquisition to begin. If no multiplexer is being used (i.e., a single probe connected directly to the cable tester), then make sure that the probe is set up as probe number 1 of multiplexer number 1. In this instance the multiplexer is a virtual device, not physically present in the system; and we are using the setup as probe 1 on multiplexer 1 as a way of recording the probe length, distance to the probe and wave form position so that the system will always find the probe and make a correct reading during automatic acquisition. See Section 1.4 for details of setting up a multiplexer, and see Section 1.2.2 for details of positioning the wave form.

2

DOCUMENTATION FOR TACQ.EXE

2.1 Program Capabilities

Program TACQ.EXE is capable of both unattended control of a time domain reflectometry (TDR) soil moisture measurement system and reduction of TDR waveforms to water contents. TACQ.EXE may be user configured to automatically or manually perform several tasks including:

- 1) Control Tektronix 1502B or 1502C TDR cable testers including setting distance to probe, Vp and DIST/DIV settings, vertical gain setting and vertical position of waveform, and filtering. Control a modified (see Chapter 7) Tektronix 1502 to output an analog wave form for external digitization. With the optional TR-302, turn off power to any Tektronix cable tester when not in use.
- 2) Individually control up to 16 Dynamax and 16 Campbell Scientific, Inc. coaxial multiplexers (using 6 pins of the computer's parallel port). More than 16 multiplexers of each type may be controlled if multiplexers using the same address are positioned on different branches of the connection tree.
- 3) Acquire waveforms from Tektronix 1502B, 1502C, or modified 1052 cable testers.
- 4) Acquire relative voltage data needed for calculation of bulk electrical conductivity (BEC) (1502B/C only).
- 5) Acquire temperature data from thermocouples using analog to digital conversion cards (Measurement Computing models CIO-DASx, PCI-DASx, and PC104-DASx, Middleboro, MA).
- 6) Reduce waveforms to travel times, apparent dielectric constants and water contents.
- 7) Control algorithms used for reduction of waveforms to water contents.
- 8) Recommend Vp and DIST/DIV settings for best wave form width on screen for any length probe.
- 9) Save to ASCII files either waveforms alone; travel times, apparent dielectric constants, and water contents alone; or both. Selectively save these data for chosen probes.
- 10) Selectively (for chosen probes) save data for BEC calculations to a separate ASCII file.
- 11) Read in ASCII waveform files previously collected; and, under user control or automatically, reduce the waveforms to travel times, apparent dielectric constants, and water contents.

2.2 Hardware and Operating System Requirements

The program will run on an IBM PC/XT or AT compatible computer with 640 kbytes of RAM and a floppy disk. However a hard disk or other mass storage is recommended for better performance, and if wave forms are to be saved to file. Computers with a PCMCIA card slot may use an SRAM card, flash RAM card, or hard disk card to store data. Most subnotebook computers are equipped with such a slot and may be configured to boot DOS and run TACQ.EXE from an SRAM PCMCIA card thus eliminating the need for a hard disk or floppy disk and decreasing power usage (see the File Formats section for limitations on data storage). The program will run on a Hewlett Packard model 200LX palm top computer if all other programs are terminated, and will correctly acquire data from a Tektronix model 1502B/C; but since the HP200LX does not have a parallel port it cannot be used to control multiplexers.

Although it is a DOS program, TACQ will run under Windows in a DOS box. This is not recommended for data acquisition because Windows puts a control layer between the DOS box and the parallel and serial port hardware. This control layer causes timing problems for communications with cable testers and multiplexers and prevents these peripherals from working reliably under Windows. For interpreting wave forms acquired elsewhere, the program may be run in a DOS box successfully if the box is kept in the foreground.

For data acquisition on a Windows 95 system, the following steps are recommended to run TACQ in a real DOS system with no Windows in the background.

- 1) Open My Computer and look for TACQ.EXE on your hard disk. Left click on TACQ.EXE and drag it to the desktop. When the query box opens, choose to create a Shortcut to TACQ on the desktop.
- 2) Left click on the TACQ shortcut and choose Properties.
- 3) In Properties, click on the Program tab.
- 4) Click on Advanced and turn on MSDOS mode. This will make Win 95 exit and boot in DOS before running TACQ.
- 5) Click on "Specify a new MS-DOS Configuration". This will allow you to input lines into the text boxes for CONFIG.SYS and AUTOEXEC.BAT that are below that button.
- 6) Click on Configuration and turn on Expanded Memory (EMS) and any other things desired in the DOS session (CDROM, Mouse, etc.). But, remember that everything that loaded here will decrease the amount of memory available for TACQ. So only choose what is needed. Expanded memory must be enabled for TACQ to run quickly (otherwise it will swap modules to disk and run more slowly).
- 7) Enter any other desired boot instructions in the CONFIG.SYS and AUTOEXEC.BAT text boxes. Be sure to enter SET PROMPT=\$P\$G on one line of the AUTOEXEC.BAT so there will be a useful DOS prompt. (If PAUSE is entered as the last line of the AUTOEXEC.BAT file, it provides the user an opportunity to press Cntrl-C and get to the DOS prompt before TACQ runs.)
- 8) Save the changes and then double click on the TACQ shortcut to run it.
- 9) A warning should appear saying that Win95 is about to shut down. Click on Yes and the computer will reboot into DOS and run TACQ. If there is a PAUSE statement as the last line of the AUTOEXEC.BAT then the computer will pause before running TACQ and a key will have to be pressed to continue. When the user quits TACQ, the computer will reboot into Win95.

When running TACQ in a remote system, we usually do not want the computer to reboot into Win95 after a power failure or glitch that shuts down the system momentarily. To avoid rebooting into Win95, a boot diskette should be in the diskette drive. The following steps create such a diskette.

- 1) Make sure there is a PAUSE statement as the last line in the AUTOEXEC.BAT in the Properties for the TACQ shortcut (see above).
- 2) In Win95, double click on the TACQ shortcut and let it boot to DOS.
- 3) Press Cntrl-C when the system pauses and says to press any key to continue. The DOS prompt will appear.
- 4) Put a diskette in the A: drive.
- 5) Go to the C: drive and type SYS A: and then press Enter. This will install DOS on the diskette. You should see a file named COMMAND.COM on A: when you do a directory of A:.
- 6) Copy the CONFIG.SYS and AUTOEXEC.BAT files from the C: drive to the A: drive.
- 7) Go to the A: drive and type EDIT AUTOEXEC.BAT and press Enter. This should put you in the DOS editor with the AUTOEXEC.BAT file in the editor.
- 8) Remove the PAUSE statement.
- 9) On the line that runs TACQ, put a space and the word AUTO after TACQ.EXE. This line will probably be the next to the last line in the AUTOEXEC.BAT file. It will begin with CALL and end with TACQ.EXE. The path to TACQ.EXE on your hard disk will be there as well.
- 10) Remove the last line of the AUTOEXEC.BAT file. It will probably read C:\WINDOWS\WIN.COM /W or something similar. This is the line that causes the computer to reboot to Win95 after TACQ runs. Save the AUTOEXEC.BAT file.
- 11) Reboot the computer with the diskette in the A: drive and DOS will boot and run TACQ.

If the computer is rebooted without the diskette in the A: drive it will first boot to DOS and run TACQ. After the user quits TACQ, the system will reboot to Win95. Do not change the AUTOEXEC.BAT and CONFIG.SYS files on the C: drive. Doing so may cause the computer to not be able to reboot to Win95.

The program will use CGA, EGA, VGA (in EGA mode), ATT, or Hercules graphics. To use Hercules graphics, the memory resident program MSHERC.COM should be run before TACQ.EXE. A parallel port is required for control of multiplexers. A serial port is required to acquire data from either the digital Tektronix 1502B or 1502C cable testers, or the modified Tektronix 1502 cable tester. The program can automatically scan serial ports COM1 through COM4; and will find the 1502B/C cable tester if it is connected and selected in Software Setup. The program will then set the cable tester to the maximum baud rate of 19,200 for the 1502B/C or 9,600 for the modified 1502. If there are multiple serial and parallel ports, the user may specify which to use. The program has been used on IBM compatible computers with CPUs ranging from 8088 to Pentium including laptop and notebook computers. Note that if the program is set for the Tektronix 1502B or 1502C and the serial cable is not connected, or the cable tester is not turned on, the program will stop and query the user after trying all possible serial ports (See Section 1.2). TACQ will run with no cable tester connected, but the user should indicate that there is no cable tester in Software Setup. Install the program by copying files TACQ.EXE, TACQ_TDR.INI, and TACQ.INI to the desired directory on the computer's hard disk. If you do not have TACQ_TDR.INI and TACQ.INI you can still run the program and create them in Software Setup.

2.3 Running TACQ Automatically

If automatic start-up of the program is desired (e.g. in case of a power failure you might want the program to re-start automatically when the power comes back on and the computer reboots) make the following lines the last 2 lines in the computer's AUTOEXEC.BAT file:

```
CD \path
TACQ AUTO
```

where "path" is the path to the subdirectory where TACQ.EXE and the *.INI files reside. If the program is installed on the root directory of the boot drive (usually C:) then only the following line is necessary:

```
TACQ AUTO
```

Note that a space should separate the words 'TACQ' and 'AUTO'.

The program also may be run from a batch file so that control is returned to the batch file after all TDR probes are read. This is done by using the line:

```
TACQ AUTOSTOP
```

This is useful when other programs will be using the data output by TACQ. For an example of this use of TACQ in an automatic irrigation system see Lascano, R.J., R.L. Baumhardt, S.K. Hicks, S.R. Evett, and J.L. Heilman. 1996. Daily measurement and calculation of crop water use. Pp. 225-230 *In* C.R. Camp, E.J. Sadler, and R.E. Yoder (eds.) Proceedings of the International Conference on Evapotranspiration and Irrigation Scheduling. Nov. 3-6, 1996, San Antonio, Texas, U.S.A. 1166 pp.

2.4 Main Menu

Run TACQ.EXE by typing TACQ and pressing the Enter key. The second and third lines of the main menu (Fig. 2-1) display the software version date, location suffix, propagation velocity (Vp), distance per division setting (DIST/DIV) and parallel port that will be used to control multiplexers (LPT1 or LPT2). The location suffix can be changed by the user during Software Setup (accessed by pressing 'S' at the main menu) and can be up to 3 characters. This suffix is used in all automatic data collection file names so that files from different installations can be differentiated. The Vp and DIST/DIV values shown are those selected in Software Setup. If a modified (Chapter 7) Tektronix 1502 cable tester is used, the user must make sure that the Vp and DIST/DIV settings in the program and those on the cable tester are identical. If the Tektronix 1502B or 1502C are used then the displayed Vp and DIST/DIV are not necessarily those used by the program since the user can select different Vp and DIST/DIV settings for each probe (see Section 2.6). See Chapter 7, Principles and Methods for Time Domain Reflectometry, for information on how Vp, DIST/DIV and probe lengths are used to compute travel times, apparent dielectric constant, and water content. The fourth line shows the hardware used for TDR data acquisition as selected by the user in setup. The fifth line shows the drive and path that the program will use for writing files. This may be changed in Software Setup. The line at the bottom of the screen gives the month, day of month and year; hour, minute and second; and the sequential day of year with January 1 as day 1. Note that directions given here and later in this document will not result in acquisition of TDR data if the cable tester, multiplexers and TDR probes are not correctly connected to the computer and to each other. See Section 1 for directions on system hookups. The main menu presents several choices for data acquisition, wave form interpretation, software setup, and control of hardware as will be discussed below.

```
TACQ, Time Domain Reflectometry (TDR) System Control Program.  USDA-ARS,
2300 Experiment Station Road, Bushland, TX 79012. Beta 09-02-1999, 09:38:16
Location Suffix: TAC      Vp: .54,  DIST/DIV: .5 m.  Using LPT1.
  Using Tektronix 1502B/1502C TDR cable tester (com1:19200,n,8,1)
Writing to: C:

Select from the following:
  Software Setup.
  File functions - Acquire & save to file, Read file
  Bring in a wave form.
  Graph TDR data.
  Control TR-200 or SDMX-50 coaxial multiplexer.
  Control Tektronix 1502B/C TDR cable tester.
  Quit.
Enter your selection:

                                     12-19-2000.   22:27:18.   DOY: 246
```

Figure 2-1. Main Menu of program TACQ.

2.4.1 Software Setup

Press S at the Main Menu to enter Software Setup (Fig. 2-2). The basic setup parameters are shown, and can be changed, here; including which cable tester is to be used, which serial port and at what speed, which parallel port and what pins on that port, the write path for files, automatic data acquisition file names,

filtering level (1502B/C only), Vp and DIST/DIV, the time interval for automatic data acquisition, and the number of times to acquire data at each interval. Not visible on the screen, but able to be changed from it, are the multiplexer and probe connections, and the type of data to be automatically acquired for each probe. If a 1502B/C cable tester is being used then the distance to each probe, and individual Vp, DIST/DIV, filter, gain, and vertical offset values for each probe, may be set.

2.4.1.1 Press T to choose a TDR instrument. A prompt will appear at the bottom of the screen. The up and down cursor keys allow selection of one of three choices: No wave form acquisition, Tektronix 1502B/1502C TDR cable tester, or Serial Interface to modified Tektronix 1502 cable tester. In most cases the 1502B/C cable tester is used. If TACQ is being used in the laboratory to interpret wave forms from files collected elsewhere, and if no cable tester is connected to the computer, then choosing 'No wave form acquisition' will avoid some problems that might occur on start up if the program were to attempt to communicate over a serial link that didn't exist. Pressing A will expand the selection choices to include the Measurement Computing (formerly ComputerBoards) analog to digital (A/D) conversion cards (Middleboro, MA); and two other A/D cards that are not currently supported. If the CIO8 is chosen, the user will have to install and configure this card and connect it to the analog wave form output of the Tektronix 1502 TDR cable tester (usually using the Tektronix X-Y Output Module). The user will also have to modify the cable tester for computer controlled toggling of wave form output by installing a relay in parallel with the toggle switch in its front panel. Details of cable tester modifications will soon be found in Chapter 8 of this manual.

```

                                SOFTWARE SETUP
TDR instrument:      Tektronix 1502B/1502C TDR cable tester
1502 defaults:      Vp: 0.99, DIST/DIV: .05 meters
                    Filter: No override.
Serial Port:        COM1:, 19200 baud, Send/Receive delay: 0, Wait: 3
Parallel Port:      LPT1:.. Pins for TR-200: DATA 2, CLOCK 3, SDE 4
                    Pins for SDMX50: DATA 6, CLOCK 7, SDE 8
                    Delay between clock ticks is approx. .006 s.
                    Power Control Pin: 9. Continuous power.

Other Data Acquisition: None
File Names:         Wave forms: 2000354T.TAC. Water contents: 2000354W.TAC
Write to: C:        Bulk electrical conductivity: 2000354E.TAC
Acquisition Interval: 1800 s. Data is acquired 1 times at each interval.
Set Date/Time:     12-20-2000, 22:29:07
Multiplexer & Probe Connections:
Probe Cable Length, Vp, DIST/DIV:
Interpretation methods:
Press T, 1, S, P, F, W, A, D, O, M, L, I or Esc:

```

Figure 2-2. Software setup screen of program TACQ.

2.4.1.2 Press 1 to choose global defaults for propagation velocity factor, Vp, distance per division on the cable tester screen (and the computer screen), DIST/DIV, and filtering. If a modified 1502 cable tester is used then the Vp and DIST/DIV settings made here will be used for all probes; and these settings must match the cable tester front panel settings. The Vp and DIST/DIV settings change the apparent width of the wave form on the cable tester screen. They must be adjusted so that the entire wave form can be seen on the screen at one time. Since wave forms become wider as soil water content increases, it is necessary to choose settings that allow the entire wave form to be seen when the soil is practically saturated. For example, for 20 cm probes a Vp setting of 0.99 and DIST/DIV setting of 0.5 feet will work well. TACQ will provide

recommended settings of Vp and DIST/DIV to provide optimum screen width for each probe length; corresponding to an expected maximum or saturated water content input by the user (0.45 is used if the user does not input a value). If the modified Tektronix 1502 cable tester is used then two choices of DIST/DIV will be shown that, with the current Vp setting, would result in screen widths that are closest to the optimum. The first choice will provide a screen width that is at, or smaller than, the optimum; and the second choice of DIST/DIV will provide a screen width that is at, or larger than, the optimum. The percent error from the optimum will also be shown. See Section 7.6.1 and Appendix 7-A for discussion of what the optimum screen width is and how the best DIST/DIV and Vp values are found. If a 1502B or 1502C cable tester is used then the Vp and DIST/DIV settings made here are overridden by the Vp and DIST/DIV choices made for each probe (See Section 2.6. Choices for individual probes may be made by pressing L at the Software Setup screen.)

The 'Filter' setting is only applicable if the 1502B/C cable testers are being used. If the default is 'No override' then the individual filter settings made for each probe (see Section 2.6) will take effect. Otherwise the filter setting (number of wave forms averaged into the one recorded wave form) chosen here will take precedence for all probes.

2.4.1.3 Press S to change serial port settings. Note that these settings cannot be changed if a cable tester is not chosen (see above). A series of prompts will appear at the bottom of the screen. Enter zero for the transmit/receive delay unless the cable is longer than 2 m, in which case increase this setting until serial communications are stable. A delay of 0.1 s has been shown to work for a serial cable (e.g. TR-2001) 1000 feet long (18 gauge, shielded, twisted pair). Accept the default value of 2 for the wait for cable tester response, unless the cable is longer than 2 m in which case you may have to increase the time to obtain stable serial communications. A value of 2 has been shown to work with the 1000 ft cable. Enter a baud rate of 19,200 for the 1502B/C cable testers, or 9600 for the modified 1502 cable tester with serial interface. These rates are for cables of 2 m length - they may have to be reduced for longer cables. A value of 9,600 was shown to work for the 1000 ft cable connected to a 1502B cable tester. Enter the number for the serial port being used (usually 1 or 2, see your computer's documentation).

2.4.1.4 Press P to change parallel port settings and TDR instrument power control. A series of prompts will appear at the bottom of the screen (Fig. 2.3). If the computer has more than one printer port, a choice of ports will be offered. Successive prompts will ask for pin numbers to be used for various tasks. Note that pressing Enter will cause the pin assignment displayed to be retained. Normally pins 2, 3, and 4 are used for the data, clock, and serial device enable (SDE) lines controlling the TR-200 multiplexer (see Chapter 5 and addendum 1). These are the defaults for the TR-2200 cable (see Chapter 3) and will usually be the defaults offered by the program. If the assignments have been changed they should be restored to the default values if the TR-2200 cable (Chapter 3) is to be used. The user may construct a cable using different pin assignments if necessary. Pins 6, 7, and 8 are used for the data, clock, and SDE lines controlling any SDMX50 multiplexers attached. Note that both multiplexers are controlled by synchronous serial signals sent through the parallel port. This is not the same as the asynchronous serial signal available at the computer's serial port(s). The delay between clock ticks on the control lines is normally about 0.006 s, but this should be increased if multiplexer control is compromised by long cable lengths.

For many users, power to the TDR instrument will be on at all times. However, Chapter 6 describes two power control devices that may be used to conserve power in battery operated systems (TR-302) or isolate the system from AC power line noise (TR-304). If these devices are not used then the defaults offered in the relevant prompts may be accepted (Fig. 2.3). Pin 9 is normally used to control power to the TDR instrument if the optional TR-302 power control module is installed (Chapter 6). If the TR-302 is not installed, enter 5 here so that the TR-2200 cable and pin 9 may be used to control the AC power control device described below. The default setting for the delay after power is turned on at the cable tester is zero. With this setting, power is always on at the TDR instrument, even with the TR-302 installed. If it is desired

to turn off power to the TDR instrument after each automatic data acquisition cycle then enter a value of at least 5 s here. The delay is required to allow the TDR instrument to initialize its serial communications firmware and hardware before the computer attempts to begin communications over the serial port. If the TR-302 is not used, then enter 9 for the pin used to signal the optional model TR-304 remote controlled AC power strip on and off; otherwise enter 5. If both the TR-302 and the TR-304 are used, the TR-2200 cable must be modified to provide an extra wire to control one of the devices. At the last prompt, enter zero to keep AC power on always; or enter 1 or more seconds for the delay to have the AC power turned off during data acquisition. This sometimes eliminates AC noise in the TDR instrument. To use this option, the instrument must have an internal battery or be externally battery powered.

| |
|----------------------------------------------------------------------------------------------------------------------------------------------------------------------------------------------------------------------------------------------------------------|
| <p>Only Parallel port # 1 exists. It will be used for system control. Press any key to continue...</p> |
| <p>Parallel port pins used to communicate with Vadose coaxial multiplexer are normally: DATA 2, CLOCK 3, SDE 4. Enter pin number for DATA. Press <Enter> for default = 2 Acceptable parallel port pin numbers are: 2, 3, 4, 5, 6, 7, 8, 9: _</p> |
| <p>Enter pin number for CLOCK. Press <Enter> for default = 3 Acceptable parallel port pin numbers are: 3, 4, 5, 6, 7, 8, 9: _</p> |
| <p>Enter pin number for SDE. Press <Enter> for default = 4 Acceptable parallel port pin numbers are: 4, 5, 6, 7, 8, 9: _</p> |
| <p>Parallel port pins used to communicate with SDMX50 coaxial multiplexer are normally: DATA 6, CLOCK 7, SDE 8. Enter pin number for DATA. Press <Enter> for default = 6 Acceptable parallel port pin numbers are: 5, 6, 7, 8, 9: _</p> |
| <p>Enter pin number for CLOCK. Press <Enter> for default = 7 Acceptable parallel port pin numbers are: 5, 7, 8, 9: _</p> |
| <p>Enter pin number for SDE. Press <Enter> for default = 8 Acceptable parallel port pin numbers are: 5, 8, 9: _</p> |
| <p>Parallel port pin used to signal power on (pin high) or off (pin low) for Tektronix 1502 is normally: 9 Enter pin number for power control. Press <Enter> for default = 9 Acceptable parallel port pin numbers are: 5, 9: _</p> |
| <p>Enter integer to set delay between clock ticks for parallel port control. Delay time is approx. the integer value times 0.003 s. Current delay time is approx. .006 s. Press <Enter> for default = 2_</p> |
| <p>Currently a 0 s delay occurs after power is turned on at the 1502. Power is on permanently. Enter number of s to delay (Enter 0 for permanent power on): _</p> |
| <p>Parallel port pin used to signal AC power strip off (pin high) or on (pin low) is normally: 5 Enter pin number for AC power control. Press <Enter> for default = 5 Acceptable parallel port pin numbers are: 5: _</p> |
| <p>Currently a 0 s delay occurs after the AC power strip is turned off. Power is on permanently. Enter number of s to delay (Enter 0 for permanent power on): _</p> |

Figure 2-3. Prompts for parallel port settings in the order that they appear and separated by horizontal lines.

2.4.1.5 Press O to set up other data acquisition. If the computer is equipped with a CIO-DASx, PCI-DASx, or PC104-DASx series analog to digital conversion board and a CIO-EXP series multiplexer board (Measurement Computing, formerly ComputerBoards, Inc., Middleboro, MA), that equipment may be used to acquire temperatures using thermocouples. Other than TDR, that is the only data acquisition supported at this time. The CIO-DAS8 series A/D boards are ISA bus cards that may be used with IBM PC/AT

compatible computers. The PCI-DASx are equivalent boards for the PCI computer bus; and the PC104-DASx boards are for embedded computers built to the PC104 bus specification. Successive prompts will query the user for the card's base address (often 768), the output channel for MUX-32 (EXP-32) channels 0-15 (may be 0), the output channel for MUX-32 channels 16-31 (may be 1), the gain for MUX-32 channels 0-15 (may be 1), the gain for MUX-32 channels 16-31 (may be 800 for thermocouples on those channels), the output channel for the cold junction temperature (may be 7), and the channel for TDR data. The latter may be 0 if the DAS8 is used to digitize TDR wave forms from a Tektronix 1502 cable tester. The scenario supported by the setup values given above is for thermocouples connected to MUX-32 channels 16-31. There is also provision for digitizing wave forms on channel 0, but this will not occur unless enabled when choosing a TDR instrument (Section 2.4.1.1). The user is encouraged to read the documentation that comes with the DASx and EXP boards for details of their use.

2.4.1.6 Press F to set files for automatic data acquisition. The file names prefixes are assigned automatically (the prefix is the part of the file name, up to 8 characters in length, to the left of the period). The user can change the suffix (up to 3 characters after the period). This allows files from different installations to have different names. The file name convention is yyyydddX.SUF where yyyy is the year (1997 for 1997, or 2000 for 2000); ddd is the serial day of the year starting with 1 on January 1 (often known as the Julian day); X is a letter identifying the file data type as explained below; and SUF is the user supplied suffix. The X identifier is T for files containing wave form data; W for files containing travel times, water contents and apparent permittivities; E for files containing relative wave form voltage data for bulk electrical conductivity calculations, and C for files containing thermocouple data. The user may chose to save data as water contents only (W files) only, as wave forms (T files) only, or in both files. The safest approach is to save data in both forms. Then, if there is any question about how the wave forms have been interpreted or about noise in the system, the wave forms can be re-interpreted by TACQ under user control (see Section 2.4.3) to find out just when and where in the system a problem occurred. However, there are large savings in disk space if only water contents are saved to file (see Section 2.8). Note that the user also controls what kind of data are saved to files in the multiplexer and probe connection setup (see Section 2.5). For each probe the user may chose to save only wave form/water content data, or only BEC data, or both. For instance, if for all probes the user has chosen to save only wave form/water content data then no data will be saved to E files. The final prompt presented to the user will be a choice of appending to, or overwriting the current files. Pressing A or the Enter key will cause the existing files to be saved and these will be appended to during the next automatic acquisition cycle.

2.4.1.7 Press W to set the write path. The disk drive and subdirectory path (if any) may be specified here. Pressing W brings up a directory of the current drive and path (usually the drive and path from which TACQ was run). The user may change drives and go up and down through the subdirectories on each drive to find the drive and path (if any) desired for file storage. Scenarios where this may be useful include running TACQ from a solid state disk in an embedded computer and writing data to a PCMCIA hard disk or ATA flash memory disk; or reading wave form data from a CDROM disk where it has been archived, interpreting the wave forms, and writing the water contents to a writeable drive elsewhere in the system. Note that changing the write path will cause the Software Setup (TACQ.INI) file to be written to the new write path. After saving the Software Setup and exiting TACQ, the user should make sure to copy the TACQ.INI file to the drive and subdirectory from which TACQ will be run in the future.

2.4.1.8 Press A to set the automatic data acquisition interval. The interval is in seconds. A complete automatic acquisition cycle will be started at each time that is an integer multiple of the acquisition interval, beginning with midnight. A complete cycle means that the software will switch the multiplexers to connect each probe to the cable tester and acquire and save to file the kinds of data that the user has enabled for each probe. Of course, a probe must be configured in software (see Section 2.5, Multiplexer & Probe Connections, below) to reflect the physical connections of multiplexers and probes before data acquisition can occur. Also,

any thermocouple data (see Section 2.4.1.5) will be acquired and written to file immediately after the TDR data are acquired. After setting the interval, the user will be prompted to set the number of times to acquire data at each interval. This number is normally one. But, some users may desire to obtain multiple readings from each probe at each acquisition interval in order to calculate statistics on the data.

2.4.1.9 Press D to set date and time. This changes the software clock but not the hardware clock. If the computer reboots, the hardware clock will be used to set the new software clock. This is an important distinction for unattended automatic acquisition. If the computer reboots after a power failure or due to a voltage transient, the program may be restarted automatically (see instructions above for setting this up in the AUTOEXEC.BAT file). But if the hardware clock is wrong, the file names and dates and times in the files will be wrong because the hardware clock is used to reset the software clock when the computer reboots. See your computer's documentation for setting the hardware clock. This is usually done in CMOS setup which, for many computers, can be entered by pressing the Esc or Del keys during computer startup. Some computers use the Ctrl-Alt-S key combination, entered at the DOS prompt, to enter CMOS setup. See your computer's documentation if CMOS setup cannot be entered in one of these ways. We suggest setting the hardware clock during every visit to remote, unattended sites.

2.4.1.10 Press M to set Multiplexer and Probe Connections. All the physical connections between multiplexers and probes must be set up in software in order for the system to acquire data automatically and unattended. Also, this must be done before the cable lengths to probes, and the individual probe Vp and DIST/DIV settings are specified (see the next subsection). During this part of software setup the length of each probe is recorded, and the user makes choices about what kind of data are to be saved for each probe. Choices include water contents, relative wave form voltages for bulk electrical conductivity calculations, or both. After setting up a probe to be attached to a particular channel of a particular multiplexer, the user may set the cable length, Vp, and DIST/DIV values for that probe interactively if a Tektronix 1502B/C cable tester, optional multiplexer and probe(s) are already installed. See Section 2.5, Set Multiplexer and Probe Connections, for detailed instructions on doing this.

2.4.1.11 Press L to set cable lengths to probes, and individual probe Vp and DIST/DIV settings. A complete explanation of this process is given in Section 2.6, Setting Cable Lengths, Vp, and DIST/DIV. An abbreviated description is included here for continuity. If a Tektronix 1502B or 1502C cable tester is being used, pressing L at the Software Setup menu allows the user to set in software the distance to each probe individually; and to set the Vp and DIST/DIV settings for each probe to the optimal settings for data acquisition given that probe's length. These settings must be made in order for the system to correctly find the wave form for each probe. In order for this part of software setup to proceed correctly, the physical connections that the user has indicated in software (see Section 2.4.1.10) must in fact exist and the multiplexers must be properly connected to power and switching signals using cables TR-2200 and TR-250; and to each other and the cable tester using cables TR-1058. Also the multiplexer and probe connections settings described in the previous section must be made before the settings described here can be successfully completed. After L is pressed, the screen will clear and briefly display a message indicating to which probe on which multiplexer the system is switching. The system automatically switches to the first probe on the first multiplexer (multiplexer 2) that is connected to multiplexer 1. If there is only one multiplexer the system will switch to the first probe on it. Make the distance, Vp, and Dist/Div setting changes needed to properly position that probe's wave form on the screen (see Section 2.6). When finished adjusting the wave form, press N to see the wave form for the next probe on multiplexer 2; or, press G to see the graph of the present wave form with the tangent lines fitted for water content determination. Right now it is preferable to press N rather than G. After all the wave form positions are set up you can go back and look at the fitting. After the user presses N, the system switches to the next probe on multiplexer 2. This continues until all connected probes (as chosen by the user in software Connection Setup) are set up. The software then switches to the next multiplexer (multiplexer 3) connected to multiplexer 1 and allows set up for the first probe on that

multiplexer, then the second probe, etc. This process continues until all probes that were indicated as connected in Connection Setup have been set up for distance, Vp, and Dist/Div.

2.4.1.12 Press I to change graphical interpretation methods. The algorithms that control the reduction of wave forms to water contents may be changed via a set of submenus accessed by pressing I. The user also has access to these changes when the wave form is displayed after B is pressed, or when the wave form is displayed as the user is reading in a file containing wave forms and reducing them to water content. Simply press D for re-do when the graphical interpretation screen is displayed. It is more useful to change these settings while a wave form is displayed. Access to these submenus is also given after the distance to a probe, Vp and DIST/DIV are set in the setup part of the program. See Section 2.6, Setting Cable Lengths, Vp, DIST/DIV. Another way to access the algorithm change submenus is to press F at the main menu and then press A for automatic data acquisition and then immediately press T for test. The computer will switch the multiplexer(s) to display each probe that has been specified (by the user in setup), acquire each wave form and display it. Data are not necessarily saved to file in test mode. A final way to access the algorithm change submenus is to press F, and then S for single wave form acquisition at the Main Menu. After the wave form is properly positioned, press G and the graphical interpretation screen will appear. See Section 2.7, Algorithms for Reducing Wave Forms to Water Contents, for information about changing these settings. Settings are saved in file TACQ_TDR.INI.

2.4.2 Bring in a Wave Form

Pressing 'B' at the Main Menu will cause the system to acquire a single wave form, display the wave form and first derivative, and reduce the wave form to a water content. If a modified Tektronix 1502 is used, the wave form should first be found by adjusting the horizontal and vertical position knobs. The wave form should be adjusted using the Vp, DIST/DIV, and horizontal position (distance) knobs so that the first peak is at, or just to the right of, the first vertical division mark on the cable tester screen; and, the second inflection occurs somewhere in the right hand half of the screen. See Sections 1.2.2 and 2.6 for information related to finding the wave form and correctly positioning it. See Section 7 for details of wave form shapes. If the Tektronix 1502B/C cable testers are used, the wave form may be placed on the screen manually or by program control. To adjust the wave form manually, first unlock the cable tester front panel by pressing 'C' at the main menu to control the cable tester and then 'U' to unlock it. Horizontal position, Vp, and DIST/DIV may then be set on the cable tester front panel. Several software controls are possible in the submenu that controls the 1502B/C. These may be accessed by first pressing 'C' to "control TDR". These will not be discussed here because TACQ provides a wave form manipulation screen to adjust the wave form under program control after B is pressed at the Main Menu. Note that bringing in a wave form by pressing B does nothing to switch multiplexers to connect a specific probe to the cable tester. To switch to a specific probe and acquire data the user should press F at the Main Menu and then press S as discussed in the next section.

After pressing B, enter the probe length or press Enter to accept the default length. Data may be saved to files by entering a file name prefix of up to 8 characters; or the user may press Enter to avoid saving to a file. If the file name is already in use, the data will be appended to the file. Comments may be entered, or not, at the next prompt. A comment serves as an identifier to distinguish one data set from another. If a model 1502C or 1502B cable tester is used then the wave form manipulation screen appears next. Use of this window to position the wave form is discussed in Section 1.2.2. When finished positioning the wave form, the user may press N to continue or G to graphically interpret the wave form for travel times. If N is pressed then no data will be saved; so press G to continue and save data to files. The graphical interpretation window, and use of different methods for wave form interpretation are discussed in Section 2.7 and Section 7. For now it is assumed that the wave form is interpreted correctly, and that the user presses Y to accept the wave form. Several messages will appear on the screen relating to acquisition of wave forms (these are for BEC data) and then a prompt appears asking if the user wants to "Acquire another wave form". As many wave forms as desired may be acquired in this fashion. Data from subsequent wave forms will be appended to the files.

2.4.3 File Functions

Pressing 'F' at the Main Menu brings up options related to file management including automatically or manually saving wave forms to files, and reading wave form files previously saved and reducing those wave forms to travel times, apparent permittivities, and water contents (Fig. 2-).

2.4.3.1 Press A for automatic data acquisition mode. The program will wait until the next acquisition interval (set in Software Setup, see Section 2.4.1.6) and then acquire data from all probes in the system (or from a single probe if there is only one). The format of the files is discussed in Section 2.8, File Formats. Data are saved in files named according to the conventions shown in Software Setup. For each probe, the kind of data saved will depend on the choices made for that probe during Probe Connection Setup. The cable tester and probe(s) and any multiplexers must be correctly connected and the user must have set up the system by pressing 'S' at the main menu and specifying the connections in software as well as setting the distances to probes in software. As discussed above, a wave form must be displayed on the cable tester screen if the Tektronix 1502 is used. If a 1502B/C cable tester is used, then the multiplexers, and channels of these occupied by probes, the distances to probe, DIST/DIV, Vp, units and other settings; saved in the Setup part of the program; will be used to position the wave forms automatically on the screen. The program will wait until the next acquisition interval (set in seconds by the user in software Setup) and then acquire data for all probes as specified in software setup (particular probes may be excluded by the user from having data saved for them). Data are saved in files that have the file name suffix supplied by the user during Software Setup. File name prefixes are combinations of the year (e.g. 1997), the day of the year (sequential starting with day 1 on Jan. 1), and one letter codes that identify the type of data. These are T for wave form data, W for water content data, and E for data useful for calculating bulk electrical conductivity. For example, for day 321 of 1997 the wave form data file would be 1997321T.TAC if the suffix supplied by the user was TAC. See Section 2.8 for File Formats.

```
Acquire data Automatically (all multiplexers & probes),  
Test &/or acquire data once from all multiplexers & probes,  
Acquire Single wave form from specific probe & multiplexer,  
Read wave form file & reduce to water content?:
```

Figure 2-4.

2.4.3.2 Press S to acquire Single wave forms. Data for user-specified probes are acquired, one probe at a time. These data are saved in ASCII files with a user supplied name prefix (up to 8 characters not including the period). The file formats are the same as for automatic acquisition; and, as for automatic acquisition, what data are saved is determined by the user in Software Setup. However, the file naming convention is different so that automatically and manually acquired data are not mixed. These files are named *.WAT, *.WAV, and *.BEC, where * is the user supplied name prefix. The WAT files contain the user supplied comment, travel times, water contents, and permittivities. The WAV files contain wave form data including Vp, DIST/DIV, and probe length. The BEC files contain data for calculation of bulk electrical conductivity. In addition there is a file named *.DIG that contains the same wave form(s) as in the *.WAV file; but in the format used by the Tektronix program SP.EXE. This file contains the user supplied comment, if any, and some additional information such as filter level, vertical offset, gain level, cursor position within the cable tester window, etc. that are not available in the other files.

After S is pressed the user is prompted for a file name. Pressing Enter alone results in no files being opened and no data being saved. But the user may still see the wave form on the screen, manipulate it, see

how it is interpreted graphically for water content, and change the interpretation algorithms. If the user supplied a file name then a prompt for a comment will appear. Pressing Enter results in no comment being saved. Note that, since files are appended to - not overwritten, the user may enter the same file name repeatedly and not lose data. Next, the user specifies a multiplexer number, and an input channel on that multiplexer. If one or more multiplexers are used then these must be set up in the software Setup part of the program, and the multiplexers and probes physically connected and properly wired, before the user can switch to a particular probe.

If there is no multiplexer (the probe is connected directly to the cable tester) the user may press Enter alone when queried for multiplexer and again when queried for channel (probe) number. Pressing Enter alone twice in this manner results in default numbers of 1 for multiplexer and 1 for channel to be assigned. The user should be aware that the data save settings and other settings, made for channel 1 of multiplexer 1 in software Setup, will be used even though there is no multiplexer in the system.

Next, the probe length may be changed; or that specified in the Setup part of the program may be accepted by pressing Enter alone. After multiplexer, probe and probe length are specified, the program will switch multiplexers (or not, if there are no multiplexers) to provide a connection to that probe. A screen will be displayed showing the wave form and allowing the user to change Vp, DIST/DIV, units, etc.; and move back and forth along the wave form (see Figs. 2-6 through 2-9 for examples). This is the same wave form manipulation screen that is used to position the wave form in the Setup part of the program (see Section 2.6). This may be useful for examining the wave guide path between the cable tester and the probe for any shorts, impedance changes, etc. If the user has previously set up the probe connections and cable lengths and wave form positions as described in Sections 2.5 and 2.6 then the probe wave forms should already be positioned correctly. If not, then follow the directions in Section 2.6 for finding and properly positioning the probe wave form. If Q or N are pressed at this screen no data will be saved, and the user will be prompted whether or not to acquire another wave form. If G is pressed then the user will next see the graphical interpretation screen (see Figs. 2-10 and 2-14 for examples). Algorithms for wave form interpretation may be altered at this screen before continuing (see Sections 2.7 and 7 for guidance). Press Y to accept the interpretation or R to reject it. All data will be written to the files regardless of whether Y or R was pressed; but if R is pressed the travel time, water content, and permittivity fields will have zeros in them. As the BEC data are gathered, several transient messages may appear on the screen regarding reading of wave forms. When the data have been written to file the user is prompted whether or not to acquire another wave form. Pressing Y or the Enter key brings up the prompt for a comment on the next wave form. Pressing N causes the files to be closed and the Main Menu will appear.

2.4.3.3 Press T to enter a test mode that will cycle through all the probes and multiplexers as in automatic mode. Unlike automatic acquisition, the user will see the wave form manipulation screen for each probe and can also see the graphical interpretation screen by pressing G at the wave form manipulation screen. If a file name is entered all data will be saved to files. The file name suffixes are the same as those used for single wave form acquisition (*.WAT, *.WAV, *.BEC). This avoids writing to the automatic data acquisition files. In this way a snapshot of the entire TDR system may be taken at any time.

2.4.3.4 Press R to read in wave forms previously acquired and interpret them for travel times and water contents. Data that are in files acquired automatically are in the Multiplexed format (even if there was no multiplexer but only one probe connected directly to the cable tester). Press M to read these files. Data in the *.DIG files discussed in Section 2.4.3.2 may be read by pressing D for digital TDR. This is compatible with data saved by the Tektronix program SP.EXE. After pressing M or D the user will see a directory of file names. Using the page up and page down keys and the cursor up and cursor down keys the user may move the highlighted bar to highlight the desired file(s) and press the + sign to select them. Then, press I. If the user has selected more than one file, a file sort screen will be displayed so the user can sort the files into the order in which they should be processed (so data in TDR.DAT will be sequential). After pressing I or after the file

sort is complete, the user will see the graphical interpretation screen with the first wave form in the file displayed. By pressing D for reDo the algorithms for interpretation may be modified, wave form smoothing level may be changed, and display characteristics (monochrome or color) may be chosen. Pressing Y will accept the interpretation and save the result to file TDR.DAT. Pressing R will save zeros to file TDR.DAT. Pressing A will cause the wave forms to be interpreted automatically without user intervention. See section 2.7 for more information on changing wave form interpretation methods.

2.4.4 Graph TDR Data.

The last wave form captured may be re-displayed by pressing 'G' at the Main Menu. If the wave form has previously been viewed in the graphical interpretation screen, its first derivative will have been computed and displayed, and it will be displayed here as well. If not, the first derivative will appear as a horizontal line through zero. The data and the first derivative of the data may be written to a file named WAVEFORM.PRN. The wave form data will be in the first column and the first derivative data will be in the second column. This is sometimes useful if the user wants to import the data into another program for computations or graphing.

2.4.5 Control Multiplexers

Any multiplexers connected to the computer may be manually switched to a given input channel by pressing '2' (for TR-200 multiplexers) or 'X' (for Campbell Scientific, Inc. SDMX50 multiplexers) and following the prompts. The user must know what address(es) the multiplexer(s) are set for. See Section 5, or the Campbell Scientific, Inc. documentation.

2.4.6 Toggle Modified 1502 Cable Tester

This Main Menu item is only seen if the user has selected the 1502 cable tester in software setup. If a modified Tektronix 1502 TDR cable tester is connected, the connection may be checked by pressing 'T'. This should cause a slowly moving dot to traverse the cable tester screen from left to right while the corresponding voltage is output on the Y output of the X-Y output module. This process takes 20 s.

2.5 Set Multiplexer and Probe Connections

Pressing M at the Software Setup screen begins the setup process for probe and multiplexer connections. A screen will appear showing all the multiplexers and the order in which they are connected:

```
Multiplexer number, type [in brackets], and address.  
No.[TYPE] Address  
1[1] 1
```

Enter number corresponding to location in tree (Press <Enter> to exit):

Typically for a new installation there will be only one multiplexer shown; and the onscreen code will be 1[1]1 which indicates multiplexer 1, type 1 (TR-200), and address 1. Press 1 and then Enter to set up this multiplexer. A multiplexer type choice will be shown:

```
Choose 1 Vadose multiplexer, 2 CSI SDMX50 multiplexer  
Enter number:
```

Press 1 if it is a TR-200 or 2 if it is an SDMX50. Next, key in the multiplexer address and press Enter. The next screen shows the channels of the multiplexer (16 for the TR-200 and 8 for the SDMX50) and the status of connections to that multiplexer.

```
Channels connected to TDR probes are marked with pluses (+), channels  
connected to other multiplexers are marked with number of multiplexer.  
Working on multiplexer number 1, model: TR-200. Navigate with cursor keys.
```

| Type of Connection | Channel No. | Probe Length (m) | Acquire What? |
|--------------------|-------------|------------------|---------------|
| | 1 | 0.2000 | ? |
| | 2 | 0.2000 | ? |
| | 3 | 0.2000 | ? |
| | 4 | 0.2000 | ? |
| | 5 | 0.2000 | ? |
| | 6 | 0.2000 | ? |
| | 7 | 0.2000 | ? |
| | 8 | 0.2000 | ? |
| | 9 | 0.2000 | ? |
| | 10 | 0.2000 | ? |
| | 11 | 0.2000 | ? |
| | 12 | 0.2000 | ? |
| | 13 | 0.2000 | ? |
| | 14 | 0.2000 | ? |
| | 15 | 0.2000 | ? |
| | 16 | 0.2000 | ? |

```
Toggle Probe connection on/off, Make/Break Multiplexer connection,  
Set cable length, Vp, DIST/DIV, etc., or <Esc>.
```

Note that there are no + signs below 'Connection' in the example above. This indicates that no probes have been assigned to any of the channels. Also, no numbers appear below 'Connection' indicating that no multiplexer connections have been assigned. Under 'Probe Length' the number 0.2000 appears for all 16 channels. Under 'Acquire What?' there is a question mark for each channel indicating that the desired type of data acquisition has not been set. The position of the highlighted area indicates which property (Connection, Probe Length, or Acquire What?) can be set and for which channel. The default position of the highlighted area is under 'Connection' for channel 1. Use the cursor keys to move the highlighted area across and up and down the screen. Note that the prompt at the bottom of the screen changes to reflect the kind of input that is needed from the user. Under 'Connection' the user can indicate a probe connection or disconnection, respectively, by pressing P to make a plus sign appear or disappear for each channel. Also the user can press M to make or break a multiplexer connection. If a probe has been connected by pressing P, the user may set the cable length, Vp, and DIST/DIV values for that probe by pressing S (assuming that the cable tester, multiplexer(s) if any, and probes are connected and working. See Section 2.6 for details of these settings). Under 'Probe Length' the user should change the assigned probe length to reflect the actual length of the probe connected to each channel. Under 'Acquire What?' the user should press W to acquire only water contents (and wave forms), press E to acquire only data (relative wave form levels) for calculation of bulk electrical conductivity, or press B to acquire both kinds of data. Also, the user can press N to acquire no data for a particular probe. When all probe connections, probe lengths and data collection choices are set as desired, press the Esc key. The next screen will be the Connection Setup screen (see beginning of this paragraph). Press enter to exit multiplexer connection setup and return to the Software Setup main screen.

If more than one multiplexer is needed then refer to the connection scheme in Fig. 1-2. Second level multiplexers should all be connected to the primary (first level) multiplexer. The following example explains how to connect two multiplexers to the primary multiplexer. Up to 16 multiplexers may be connected to the primary multiplexer. None of the second level multiplexers should share an address with the primary multiplexer; and only the 16th second level multiplexer should share an address with any other second level multiplexer. Press M for multiplexer and probe connections. The first multiplexer setup screen is shown

```

Connection Setup
Multiplexer number, type [in brackets], and address.
No.[TYPE] Address
1[1] 1

Enter number corresponding to location in tree (Press <Enter> to exit):

```

Press 1 and Enter and a multiplexer type choice will be presented:

```

Choose 1 Vadose multiplexer, 2 CSI SDMX50 multiplexer
Enter number:

```

Press 1 to select the Vadose multiplexer and a multiplexer address choice will be presented. Enter the address of multiplexer number 1, i.e. the address of the single multiplexer at MUX level 1. The next screen allows setting of connections for each channel on multiplexer 1. Position the highlighted area under 'Connection' and on the channel to which multiplexer 2 is connected (this is the first multiplexer in MUX level 2 that is connected to multiplexer 1). Press M and then C to set up the connection in software. Press 1 to indicate a Vadose multiplexer is connected and then enter the address of the multiplexer.

Channels connected to TDR probes are marked with pluses (+), channels connected to other multiplexers are marked with number of multiplexer. Working on multiplexer number 1, model: TR-200. Navigate with cursor keys.

| Type of Connection | Channel No. | Probe Length (m) | Acquire What? |
|--------------------|-------------|------------------|---------------|
| ██████████ | 1 | 0.2000 | ? |
| | 2 | 0.2000 | ? |
| | 3 | 0.2000 | ? |
| | 4 | 0.2000 | ? |
| | 5 | 0.2000 | ? |
| | 6 | 0.2000 | ? |
| | 7 | 0.2000 | ? |
| | 8 | 0.2000 | ? |
| | 9 | 0.2000 | ? |
| | 10 | 0.2000 | ? |
| | 11 | 0.2000 | ? |
| | 12 | 0.2000 | ? |
| | 13 | 0.2000 | ? |
| | 14 | 0.2000 | ? |
| | 15 | 0.2000 | ? |
| | 16 | 0.2000 | ? |

Toggle Probe connection on/off, Make/Break Multiplexer connection, Set cable length, Vp, DIST/DIV, etc., or <Esc>.

The next screen indicates that a multiplexer is connected to multiplexer 1 (in this case on channel 1). The word Multiplexer appears under 'Acquire What?'. The number 2 under 'Connection' shows that the connected

Channels connected to TDR probes are marked with pluses (+), channels connected to other multiplexers are marked with number of multiplexer. Working on multiplexer number 1, model: TR-200. Navigate with cursor keys.

| Type of Connection | Channel No. | Probe Length (m) | Acquire What? |
|--------------------|-------------|------------------|---------------|
| ██████2██████ | 1 | 0.2000 | Multiplexer |
| | 2 | 0.2000 | ? |
| | 3 | 0.2000 | ? |
| | 4 | 0.2000 | ? |
| | 5 | 0.2000 | ? |
| | 6 | 0.2000 | ? |
| | 7 | 0.2000 | ? |
| | 8 | 0.2000 | ? |
| | 9 | 0.2000 | ? |
| | 10 | 0.2000 | ? |
| | 11 | 0.2000 | ? |
| | 12 | 0.2000 | ? |
| | 13 | 0.2000 | ? |
| | 14 | 0.2000 | ? |
| | 15 | 0.2000 | ? |
| | 16 | 0.2000 | ? |

Toggle Probe connection on/off, Make/Break Multiplexer connection, Set cable length, Vp, DIST/DIV, etc., or <Esc>.

multiplexer is the second multiplexer. Note that 2 is not necessarily the address number for multiplexer 2.

Now move the highlighted area to channel 2 (assuming that this is where the third multiplexer is connected) and connect another multiplexer resulting in a screen like:

```

Channels connected to TDR probes are marked with pluses (+), channels
connected to other multiplexers are marked with number of multiplexer.
Working on multiplexer number 1, model: TR-200. Navigate with cursor keys.
  Type of Channel   Probe   Acquire
Connection No.    Length (m)   What?
    2              1      0.2000  Multiplexer
  3              2      0.2000  Multiplexer
                3      0.2000   ?
                4      0.2000   ?
                5      0.2000   ?
                6      0.2000   ?
                7      0.2000   ?
                8      0.2000   ?
                9      0.2000   ?
               10      0.2000   ?
               11      0.2000   ?
               12      0.2000   ?
               13      0.2000   ?
               14      0.2000   ?
               15      0.2000   ?
               16      0.2000   ?

Toggle Probe connection on/off, Make/Break Multiplexer connection,
Set cable length, Vp, DIST/DIV, etc., or <Esc>.

```

Repeat this process until all the multiplexers that are physically connected (or that will be physically connected) to multiplexer 1 are shown as connected in software as well. When finished, press the Esc key. Assuming that two multiplexers were connected to multiplexer 1 the next screen will be:

```

Connection Setup
Multiplexer number, type [in brackets], and address.
No.[TYPE] Address
1[1] 1
  2[1] 2
  3[1] 3

Enter number corresponding to location in tree (Press <Enter> to exit):

```

This screen also assumes that the addresses of the three multiplexers were 1, 2, and 3 for multiplexer 1 (MUX level 1) and multiplexers 2 and 3 (MUX level 2), respectively. The addresses could just as easily have been 16, 13, and 5.

Now the probe connections to multiplexers 2 and 3 should be set up. Press 2 to see the connection setup screen for multiplexer 2. Move the highlighted area with the cursor keys and press P until a plus sign appears for every channel to which a probe is physically connected. Move to the 'Probe Length' column and enter the actual probe length for each connected probe. Finally, move to the 'Acquire What?' column and

make entries indicating the desired type of data acquisition for each probe. The following figure shows the setup for multiplexer 2 when 12 probes, each 20-cm long, have been set up on the first 12 channels. Water content has been chosen as output, not water content and BEC.

Channels connected to TDR probes are marked with pluses (+), channels connected to other multiplexers are marked with number of multiplexer.
 Working on multiplexer number 2, model: TR-200. Navigate with cursor keys.

| Type of Connection | Channel No. | Probe Length (m) | Acquire What? |
|--------------------|-------------|------------------|---------------|
| + | 1 | 0.2000 | W |
| + | 2 | 0.2000 | W |
| + | 3 | 0.2000 | W |
| + | 4 | 0.2000 | W |
| + | 5 | 0.2000 | W |
| + | 6 | 0.2000 | W |
| + | 7 | 0.2000 | W |
| + | 8 | 0.2000 | W |
| + | 9 | 0.2000 | W |
| + | 10 | 0.2000 | W |
| + | 11 | 0.2000 | W |
| + | 12 | 0.2000 | W |
| | 13 | 0.2000 | ? |
| | 14 | 0.2000 | ? |
| | 15 | 0.2000 | ? |
| | 16 | 0.2000 | ? |

Acquire Water content or Bulk EC or Both or Neither, or <Esc>.

Press Esc when through setting up the probe connections for multiplexer 2, and the Connection Setup screen will appear again. Now press 3 to set up multiplexer 3 probe connections, etc. The following figure shows the screen when 8 probes, each 20-cm long, have been set up for the first 8 channels of multiplexer 3. Note that, with the highlighted area focused on the probe connection to channel 8, the user may press S to set the cable length, VP, and DIST/DIV values for this probe if the cable tester, multiplexers, and probes are all installed and working. See Section 2.6 for details of these settings.

Channels connected to TDR probes are marked with pluses (+), channels connected to other multiplexers are marked with number of multiplexer. Working on multiplexer number 3, model: TR-200. Navigate with cursor keys.

| Type of Connection | Channel No. | Probe Length (m) | Acquire What? |
|--------------------|-------------|------------------|---------------|
| + | 1 | 0.2000 | W |
| + | 2 | 0.2000 | W |
| + | 3 | 0.2000 | W |
| + | 4 | 0.2000 | W |
| + | 5 | 0.2000 | W |
| + | 6 | 0.2000 | W |
| + | 7 | 0.2000 | W |
| + | 8 | 0.2000 | W |
| | 9 | 0.2000 | ? |
| | 10 | 0.2000 | ? |
| | 11 | 0.2000 | ? |
| | 12 | 0.2000 | ? |
| | 13 | 0.2000 | ? |
| | 14 | 0.2000 | ? |
| | 15 | 0.2000 | ? |
| | 16 | 0.2000 | ? |

Toggle Probe connection on/off, Make/Break Multiplexer connection, Set cable length, Vp, DIST/DIV, etc., or <Esc>.

Repeat this process to set up probe connections for every multiplexer that has been connected to multiplexer 1.

When all multiplexer and probe connections have been set up in software, press Enter at the Connection Setup screen. A screen similar to the following will be displayed. In this example, the previous setup (not shown) had 5 probes assigned to multiplexer 1 and there were no other multiplexers. The current setup has 2 more multiplexers and no probes assigned to multiplexer 1 so there were no probes in common between the old and new setups.

```

There were 5 probes in the system before changes.
There are 20 probes in the new system.
Looking at old probe list...
There were 0 probes common to new and old lists.
Looking at new probe list...
Number of probes in old list: 5
There were 20 new probes.
These will be added to the end of the acquisition list.
Press any key to continue ...

```

Pressing any key will display the following screen which shows the default sequential order of acquisition of data from the probes in the system. You may follow the prompts and move individual probes to different places in the order of acquisition. Or, you may automatically sort the probes in one of two ways. One sort ranks the probes by multiplexer number and then by channel number on each multiplexer. The other sort is the result of a recursive search of the multiplexer and probe setup. The recursive search order is that used

by TACQ prior to the July, 1997 release. If many new probes have been added to ones previously assigned to the system, you may want to press S or R to sort them rather than moving them individually. Press Esc when finished arranging the order of acquisition and the Software Setup menu will appear.

```
Sequential acquisition order:
 1> mux 2, chan. 1
 2> mux 2, chan. 2
 3> mux 2, chan. 3
 4> mux 2, chan. 4
 5> mux 2, chan. 5
 6> mux 2, chan. 6
 7> mux 2, chan. 7
 8> mux 2, chan. 8
 9> mux 2, chan. 9
10> mux 2, chan. 10
11> mux 2, chan. 11
12> mux 2, chan. 12
13> mux 3, chan. 1
14> mux 3, chan. 2
15> mux 3, chan. 3
16> mux 3, chan. 4
17> mux 3, chan. 5
18> mux 3, chan. 6
19> mux 3, chan. 7
20> mux 3, chan. 8

Re-arrange acquisition order of probes:
[M]ove one probe at a time;
[S]ort by mux #, and channel # on mux;
Sort by [R]ecursive search (TACQ default);
<Esc> to exit:

Press [M] to move; then use <Pg-Up/Pg-Dn/!!>. Press <Enter> to end move.
```

If a Tektronix 1502B or 1502C cable tester is being used, pressing L at the Software Setup menu allows the user to set in software the distance (cable length) to each probe individually; and to set the Vp and DIST/DIV settings for each probe to the optimal settings for data acquisition given that probe's length. The next section describes how to do this. When finished, exit Software Setup by pressing Esc. Be sure to press Y to save the setup to disk.

2.6 Setting Cable Lengths, Vp, Dist/Div

With the Tektronix 1502B or 1502C cable testers, different cable lengths are accommodated by having the user interactively set the wave form horizontal position on the cable tester as the computer records the distance setting. Different rod lengths on different probes are accommodated as well (see Section 2.5). The Vp and DIST/DIV settings can be set interactively so that wave forms for probes having different rod lengths still occupy the full screen. This results in the best possible resolution for any rod length; and it ensures that there are an equivalent number of data points for graphical interpretation, no matter what the probe length. The program will recommend a good combination of Vp and DIST/DIV settings for the rod length of each probe. The recommended settings provide the best resolution (widest wave form) possible while ensuring that the wave form will not be too wide to fit the screen when the soil is saturated (the wave form becomes wider as the soil becomes wetter). The settings are stored automatically in file TACQ.INI and are used every time the program is run until changed by the user. When wave forms are interpreted for water content, the Vp, DIST/DIV and probe length settings are used in the calculations of the travel times. When wave form data are stored on disk these settings are stored as well (see Section 2.8 on data file formats) so that a program that subsequently reduces wave forms to water contents can read in the setting values and correctly interpret the wave forms. For instance, TACQ.EXE will read in the wave form files previously stored by TACQ.EXE (say, in the field) and correctly interpret the wave forms based on the individual Vp, DIST/DIV and probe length settings for each probe.

This section does not apply to systems using the older Tektronix 1502 analog cable tester which can only be adjusted manually. With the 1502, the user must make sure that travel times, from the cable tester to the probe handles, are equivalent (equivalent total cable length) for all probes in the system. Different probe lengths can be used, but for the 1502 the DIST/DIV and Vp settings must be those needed for the longest probes because these settings remain constant unless changed by the user on the front panel of the cable tester. The shorter probes will have correspondingly shorter wave forms on the screen, resulting in loss of resolution.

The interactive process begins in the Setup part of the program. Since this process uses the actual wave forms from the installed probes, the system setup must be complete before cable lengths and wave form positions can be set in this manner. This means that the multiplexers must be wired and powered, and connected to the computer via cable TR-2200. The probes must be installed and connected to the multiplexers. The multiplexers must be interconnected with coaxial cable (TR-1058), and the primary multiplexer must be connected to the cable tester with coaxial cable. See Section 1 for instructions on physical connections. All items in the Software Setup menu above “Probe Cable Length, Vp, DIST/DIV” must be completed so that communications between the computer and cable tester, and between the computer and multiplexers can be implemented. Note, however, that cable length, Vp, and DIST/DIV values for individual probes may be set for each probe during the Multiplexer and Probe Connection Setup (Section 2.5), if all items in the Software Setup menu above “Multiplexer and Probe Connections” are correct and the hardware is correctly installed as just described. If accessed from the Multiplexer and Probe Connection Setup, the cable length, Vp, and DIST/DIV setup proceeds in the same way as described below. Accessing this setup from the Multiplexer and Probe Connection Setup may save considerable time if the system has been set up previously and changes are needed for only one or a few probes.

Press L at the Software Setup menu to begin. The following screen will appear (The multiplexer and line numbers may be different for your system. Line means channel.):

```
Switched to line 1 of multiplexer 2
```

Note that the computer has switched the multiplexers so that the first probe on the second multiplexer is connected to the cable tester. In this example the primary multiplexer has a secondary multiplexer connected to its channel 1; and the secondary multiplexer has a probe connected to its channel 1. In general the program looks at the first channel of multiplexer 1 and if a multiplexer is connected to this channel that multiplexer will be multiplexer 2. The program will look at the first channel on multiplexer 2 and if another multiplexer (no. 3) is connected to this channel the program will look at channel 1 on multiplexer 3. In other words if a multiplexer is connected to a channel the program first looks at channels on the connected multiplexer, otherwise it looks at the probe and then goes to the next channel. (Note that we do not recommend hooking multiplexers together three deep in this manner. We recommend using one primary multiplexer with second level multiplexers connected directly to input channels of the primary multiplexer.)

After a brief time the program will display the wave form on the manipulation screen (Fig. 2-6). Because the cable tester initializes at start up to put the cursor at zero distance, when you are first setting up a system you will likely see a wave form like the one displayed in Fig. 2-6. This shows the first meter of cable. Usually you must search for the probe wave form by using the F and B keys to move forwards and backwards along the wave form; or, press 'E' to enter the distance to the wave form if you have an idea what that is. Pressing the F and B keys will move the window forward (longer distances) and backward, respectively, one window width at a time. Pressing H and then F or B, respectively, moves the window one half of its width in the respective direction. The user must adjust the view forwards or backwards until the wave form is properly positioned. An improperly positioned wave form cannot be correctly interpreted for water content determination by the software. Positioning is done by pressing the F, B, and H keys; by using the S key to fine tune the starting point (left hand side of the screen); and by changing the wave form width on the screen by changing the Vp and DIST/DIV settings. The first step is to find the part of the wave form that represents reflections from the TDR probe. To make a good guess at the distance to the probe we must first understand the concepts of Vp and DIST/DIV and how these settings affect the apparent distance and wave form width.

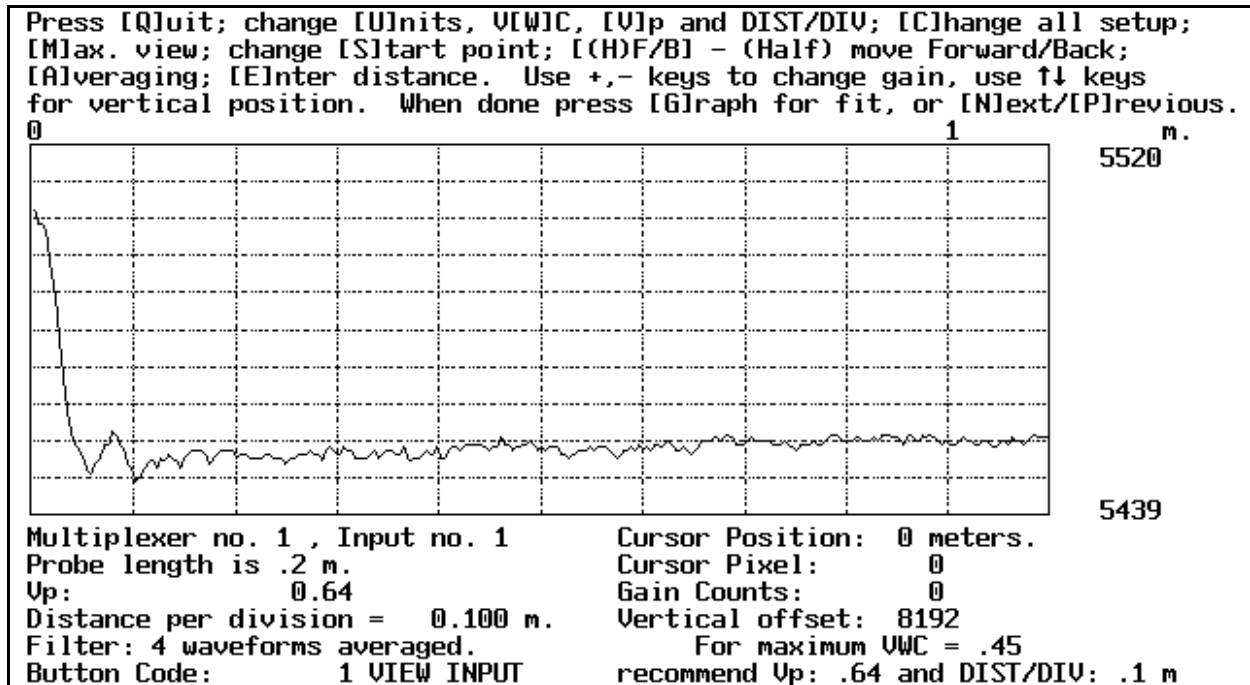

Figure 2-6. Wave form manipulation window before probe wave form is located.

The DIST/DIV (distance per division) setting dictates the width of each division of the window in length units. There are 10 divisions, so the window width is 10xDIST/DIV. The Vp is the relative velocity of propagation (relative to the speed of light, c) that the cable tester uses to convert time to distance before displaying the data. Changing either the Vp or DIST/DIV values will change the horizontal width of the wave form shown on the screen. Note that the cable tester actually measures time, not distance, but it displays distance. The distance displayed on the screen will be correct only if the Vp setting is appropriate for the cable being used. This is because different cables use different plastic insulating compounds between the inner conductor and outer conductor (shield), and the different permittivities of these compounds cause the TDR signal to travel faster (lower permittivity) or slower (higher permittivity). For most cables with polyethylene insulation, a Vp setting of 0.66 will cause the distances calculated by the cable tester to be close to the actual distances along the cable. Changing Vp will affect the distances shown on the graph; and it will change what is shown in the graph window. Using a smaller Vp will cause the apparent distance calculated by the cable tester to be smaller (distance = velocity x time) and features on the screen will become smaller in width. In effect, the window shows a longer actual view of reflections from the wave guide (this may include views of the wave guide inside the cable tester, in the cable between cable tester and probe, and/or the probe and beyond the probe).

The following procedure will place the wave form fairly close to the desired position. Press V and enter 0.66 followed by the Enter key. Then use the up and down cursor keys to select a DIST/DIV setting equal to the one recommended in the lower right corner of the screen. Measure the length of cable between the cable tester and the probe. Make sure that the units of your measured distance match those on the screen. Press E and enter the distance measured minus about 0.3 m or 1 ft (for Alpha RG58. For Belden RG58 use 0.1 m). The wave form should now include some of the reflections from the probe. Figure 2-7 shows a wave form for a 20 cm probe with a 3 m cable that was positioned using this procedure. Although this is not the desired position, it is close enough to allow fine tuning.

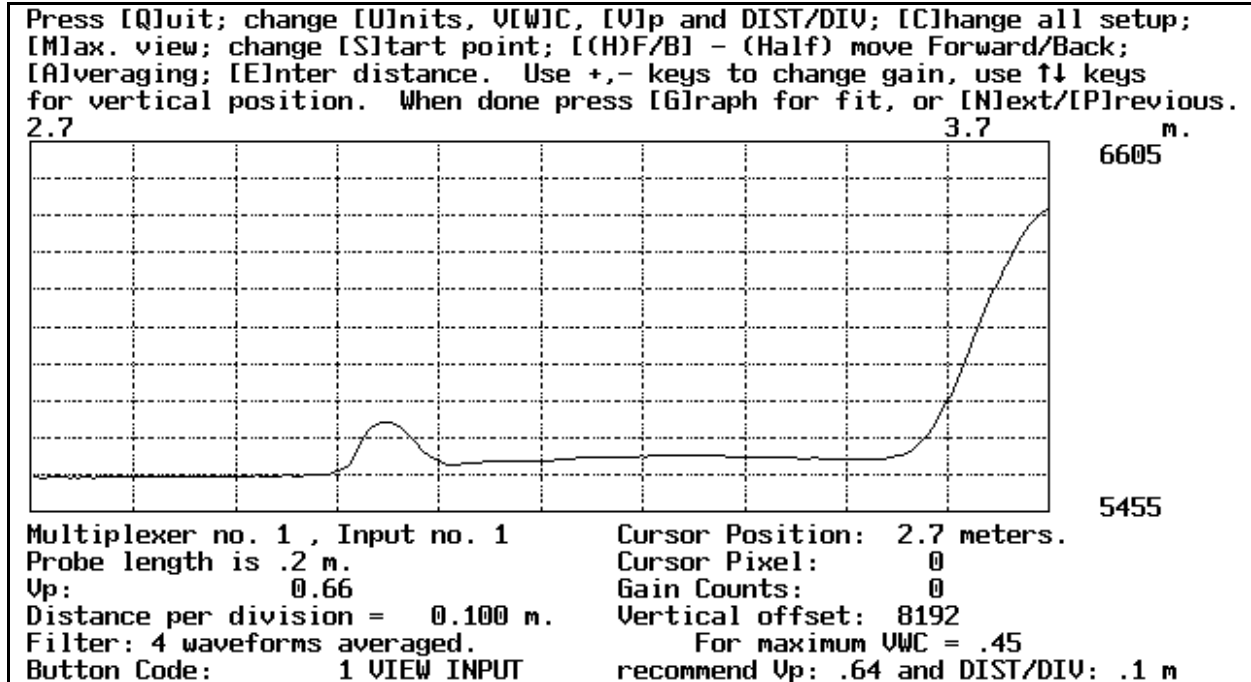

Figure 2-7. Wave form manipulation screen for probe on 3 m cable after first attempt to position wave form. Probe is in saturated sand.

In the lower right corner of the screen are given recommended Vp and DIST/DIV settings for the current probe length and maximum expected water content. If your maximum expected water content (usually the saturated water content or total porosity in m³ m⁻³) is not the same as that shown, press W to change it. Press V to change Vp and DIST/DIV to the recommended values, thus adjusting the wave form to the proper width. See Section 7.6.1 and Appendix 7-A for a definition of proper wave form width and explanation of how the program determines the best Vp and DIST/DIV settings.

Fine tune the position of the first peak by pressing S and moving the vertical line with the cursor keys. When finished, pressing Esc will re-set the left hand border of the screen to the new position of the line. The desired position of the first peak is just to the right of the first vertical grid mark (Fig. 2-8). A typical wave form for a probe in dry sand is shown in Fig. 2-9. If the wave form is too far to the left, it may quickly be moved to the right by pressing E and entering a distance slightly less than that shown just above the upper left corner of the graph.

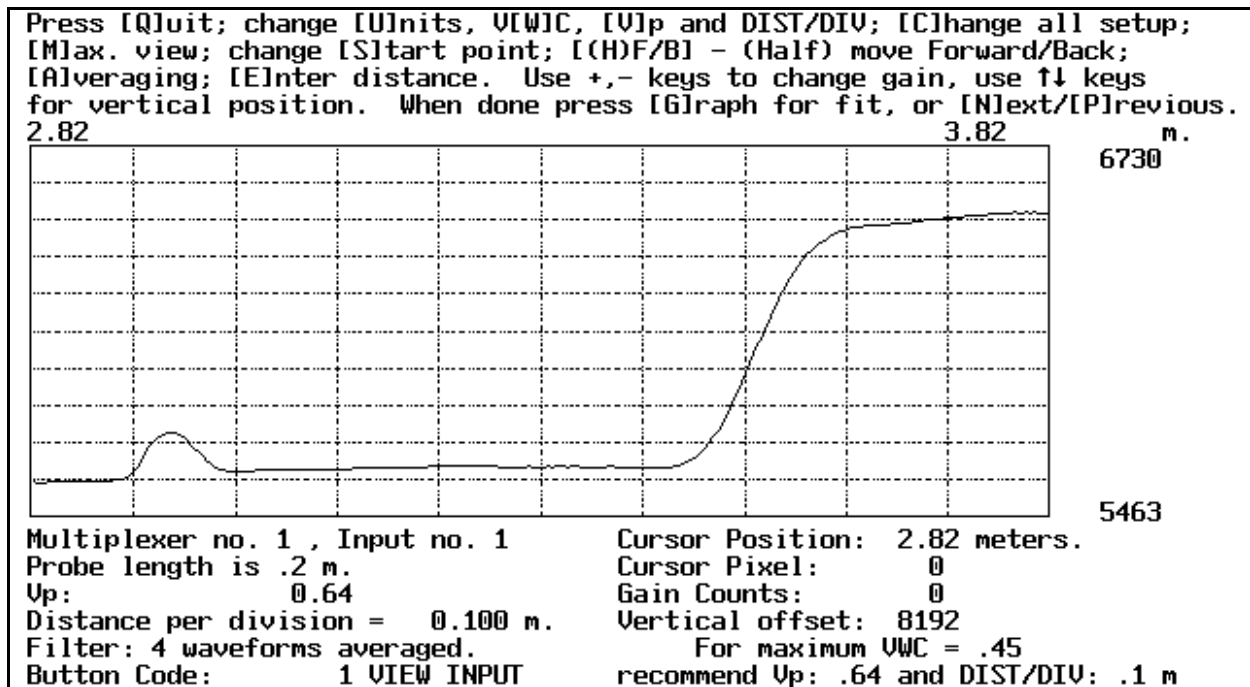

Figure 2-8. Wave form manipulation screen for probe on 3 m cable after adjusting the left hand border by pressing the S key and using the cursor keys. Probe is in saturated sand.

There is usually no need to adjust the vertical position and gain; but, when the wave form is properly positioned horizontally, the vertical position can be adjusted using the up and down arrow keys; and the gain can be adjusted using the + and - keys (Fig. 2-8). Care should be taken that the wave form is not over-magnified using the gain control nor positioned too high or too low. Since the wave form shape may change over time, as the soil wets and dries, allowance must be made for these shape changes so that the entire wave form will remain on the screen at all times. A good rule is to not adjust the gain and vertical position controls.

Pressing A allows the filtering level to be set (number of wave forms averaged before mean wave form is sent to the computer by the 1502B/C). In many situations no averaging will produce acceptable wave forms. If noise is causing problems with graphical interpretation of wave forms the filtering level may be

adjusted for up to 128 wave forms averaged. Note that the wave form interpretation part of TACQ allows wave form smoothing which may be adequate to overcome any noise problems.

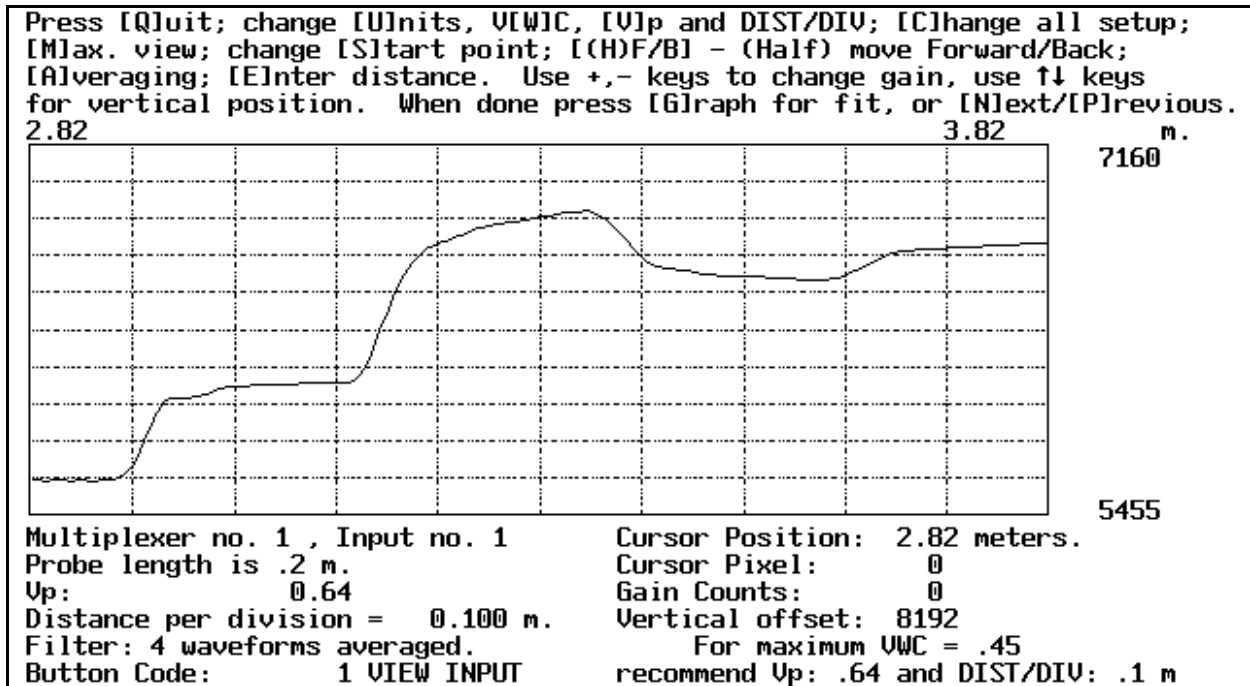

Figure 2-9. Wave form manipulation screen for probe on 3 m cable after adjusting the left hand border by pressing the S key and using the cursor keys. Probe is in air dry sand.

When finished adjusting the wave form, press N to see the wave form for the next probe on multiplexer 2; or, press G to see the graph of the present wave form with the tangent lines fitted for water content determination. Right now it is preferable to press N rather than G. After all the wave form positions are set up you can go back and look at the fitting. When the user presses N, the system switches to the next probe on multiplexer 2. (The user may also press P to return to the previous wave form.) Find and position the wave form for this probe and repeat the process until all probes on all multiplexers (as chosen by the user in Connection Setup) are set up. If this is the first time a system has been set up, the program will use the settings from the previous probe to set the initial position and width of the next probe. The user may accept this by pressing N to go to the next probe, or make adjustments if necessary. At the end of this process a prompt will appear asking if the information should be saved. Press Y to save this setup for distance to probe, Vp, and DIST/DIV. You will be returned to the Software Setup screen. Press Esc to exit Software Setup and press Y when prompted to save the entire setup.

If 'G' is pressed (Fig. 2-8) the computer acquires the wave form and displays it (Fig. 2-10). By pressing 'D' (re-do) when the graph is displayed, the user has the option of changing various settings that affect how the travel times are found. See section 2.7, Algorithms for Reducing Wave Forms to Water Contents, for more information. Note that the wave form is displayed on the lower part of the computer screen while its first derivative is displayed above it. The intersecting straight lines represent tangents fit to the data for interpreting travel times. The vertical straight lines indicate key travel times (from left to right: t1.bis, t1, and t2). The user may return to the Wave Form Manipulation screen to adjust the wave form position. This is done by pressing D for re-do and then W for manipulate [W]ave form.

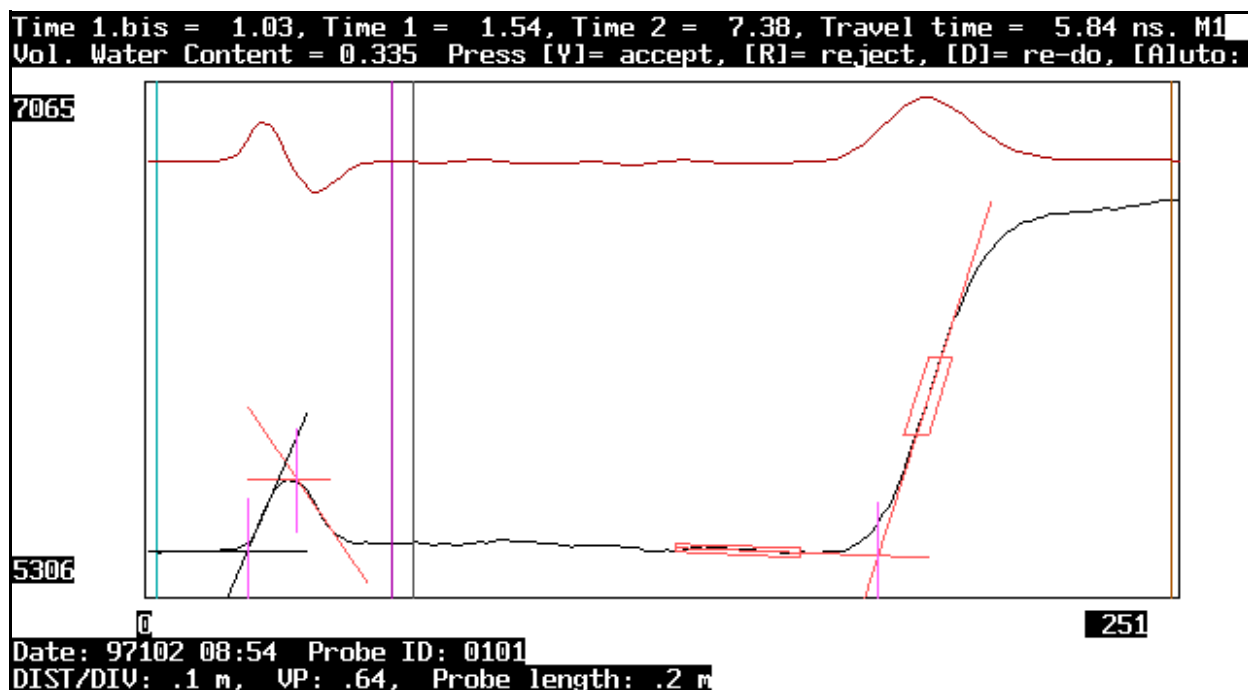

Figure 2-10. Example graphical interpretation screen for probe in wet sand.

2.7 Algorithms for Reducing Wave Forms to Water Contents

As noted in the previous section the algorithms used for wave form reduction may be changed by the user. This can be accomplished from the Software Setup menu by pressing I; or while setting cable lengths, etc. interactively as noted above. The user can also press F at the main menu and then press S for single wave form acquisition. This will cause the program to acquire a wave form and display it in the wave form manipulation screen. Pressing G at the wave form manipulation screen will cause the graphical interpretation screen to appear (see example in Fig. 2-10). When a screen like Figure 2-10 is displayed, pressing D will cause the prompts in Figure 2-11 to appear. The user may change the algorithm settings and save those changes. Another way to access algorithm settings is to press F at the main menu, followed by R to read in a wave form file for reduction to water content. The settings can be accessed as each wave form is analyzed. For the present discussion we will assume that the user has pressed I at the Software Setup menu. This section also assumes basic understanding of wave form morphology and terminology as discussed in Section 7. Wave form features discussed here are shown in Figure 2-12 (or 7-3). Changes can be made affecting the determination of travel times (t_1 and t_2), smoothing, flagging of negative water contents, screen appearance, etc. (Fig. 2-11).

```
Change method: Time [1], Time [2], [V]erbose mode, [S]moothing, [C]orrection,
[N]egative Theta limit, [M]onochrome, [L]ength, go to [D]ate, [T]ry fit,
Manipulate [W]ave form, [Q]uit, or save to [F]ile:
```

Figure 2-11

The 'verbose mode' settings are several. The first, if enabled, will print to the screen various intermediate results during the wave form reduction to water content. These are primarily of interest to the programmer. The second verbose mode setting can enable a warning that time 2 is much greater than the time of the minimum value of the wave form after time 1. The third setting can enable a plot of the smoothed wave form. The fourth setting can enable the exit from automatic mode if an error is encountered by the program. This is the most important setting for the user. If unattended automatic data acquisition and reduction of wave forms to water contents is desired then the fourth setting should be to disable the exit from automatic mode. This is so that a bad wave form resulting from disturbance of a probe or electromagnetic noise cannot stop the unattended data acquisition.

The 'negative theta limit' is present because wave forms from very dry soils can sometimes result in water contents that are close to zero. Random variations will result in negative water contents being calculated. Adjusting the negative theta limit allows some negative values to be accepted without the program being stopped. Values below the limit will cause the program to stop and alert the user. For unattended data acquisition we recommend setting the negative theta limit to -100.

'Smoothing' is done by a Savitsky-Golay routine. Using a 9 point smooth of the wave form and a 5 point smooth of the first derivative works well. Too much smoothing will cause tangents to be placed incorrectly. Too little smoothing will cause noise in the first derivative leading to noise in the water content determinations (primarily due to noise in the determination of time 2). Press S to change smoothing settings.

The 'Correction' selection allows a linear correction factor to be entered. This changes the travel time directly. An example of its use would be when the probe length was incorrect for some reason. A linear correction on travel time would compensate for this. Another example would be if Vp or DIST/DIV were set differently on the older model 1502 cable tester and in software during a prior data acquisition. Linear corrections can be calculated and entered here to correct the discrepancy.

'Change to Monochrome' allows the colored tangent lines to be rendered in black and white. This enhances visibility on some monochrome monitors or LCD panels.

'Length' of the probe may be changed (temporarily) by pressing L. To change the length permanently use Multiplexer & Probe Connections in Software Setup.

'Go to Date' allows the user to skip the data in a wave form file until a specific day and hour.

'Try fit' applies the currently selected algorithms to the wave form analysis of the present wave form

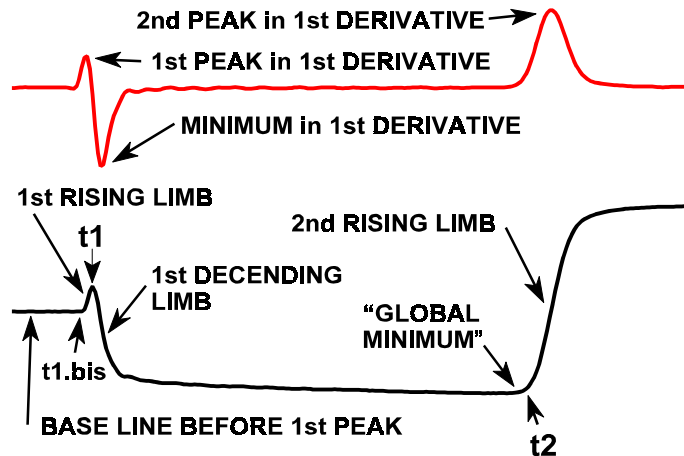

Figure 2-12. The TDR wave form (bottom) and its first derivative with respect to time(top), with features labeled.

and presents a revised graphical interpretation screen. The user may make more changes to the algorithms after this, or press R or Y to reject or accept the analysis and move on to the next wave form. The currently selected algorithms will be applied to the subsequent wave forms.

'Manipulate Wave form' allows the user to return to the Wave Form Manipulation Screen and adjust the wave form position. This prompt is only seen if the wave form was acquired directly from the cable tester. When wave forms are read in from a previously acquired file the prompt is not seen.

'Save to File' saves all the currently selected algorithms to file TACQ-TDR.INI so that they will become the default wave form analysis methods the next time that TACQ is run.

Pressing 1 or 2 allows the user to make changes to the algorithms used to find t1 and t2, respectively. These will be described in more detail below.

Press 1 to make changes in methods for finding t1 and the menu shown in Fig. 2-13 appears.

| |
|---------------------------------------------------------------------------------------------------------------------------------------------------------|
| Change [S]wath width to right of peak, [B]eginning point for data analysis, Safety [L]imit, swath for max. 1st [D]erivative, [M]ethod, or use [C]ursor: |
|---------------------------------------------------------------------------------------------------------------------------------------------------------|

Figure 2-13

The '[S]wath width to right of peak' refers to how many data points of the wave form to the right of the first peak in the wave form will be searched to find the most negative first derivative. The point at which the most negative first derivative occurs is the point of steepest descent of the wave form after the first peak. A tangent line is fit to the wave form at this point. The intersection of the tangent line and a horizontal line drawn across the first peak in the wave form is one way to define time 1 (t1). In extremely dry or loose soils the wave form sometimes displays double first peaks. The limited swath of data examined for the most negative first derivative eliminates the possibility that the tangent to the descending wave form would be drawn after the second peak.

The '[B]eginning point for data analysis' allows some data at the start of the wave form to be disregarded. This has little usefulness for data acquired from the Tektronix 1502B or 1502C digital cable testers. However, data from the Tektronix 1502 must be digitized externally and timing problems can sometimes cause noise in the data at the start of the wave form.

The 'Safety Limit' allows the exclusion of data at the start of the wave form when searching for the first peak in the first derivative.

The 'swath for max. 1st [D]erivative' puts an upper limit on the data that will be searched for the first peak in the first derivative. This prevents the second peak in the first derivative from being confused with the first peak.

The '[M]ethod' selection allows two choices for methods of computing time 1. Method 1 uses the intersection between a horizontal line, drawn across the top of the first peak in the wave form, and a tangent line fit to the descending wave form immediately after this first peak. This used to be the more commonly used method. Method 2 finds a time associated with the intersection of a horizontal line, drawn through the base line of the wave form before the first peak, and a tangent line fit to the ascending wave form before the first peak. This time (t1.bis) is less than time 1 but the interval between this time and time 1 is reproducible. This is essentially the pulse transit time in the handle. The interval can be measured for any probe by putting the probe in saturated sand and making repeated measurements. TACQ can then be used to analysis the wave forms to find repeated values of the two time 1 values (t1.bis and t1). Subtracting t1.bis from t1 and plotting the results in a spreadsheet will show graphically what the transit time is. Enter the transit time when prompted here. Method 2 is much more reliable when soils are dry. See Section 7 for more information. An example graphical interpretation screen for a dry sand using method 2 is shown in Fig. 2-14.

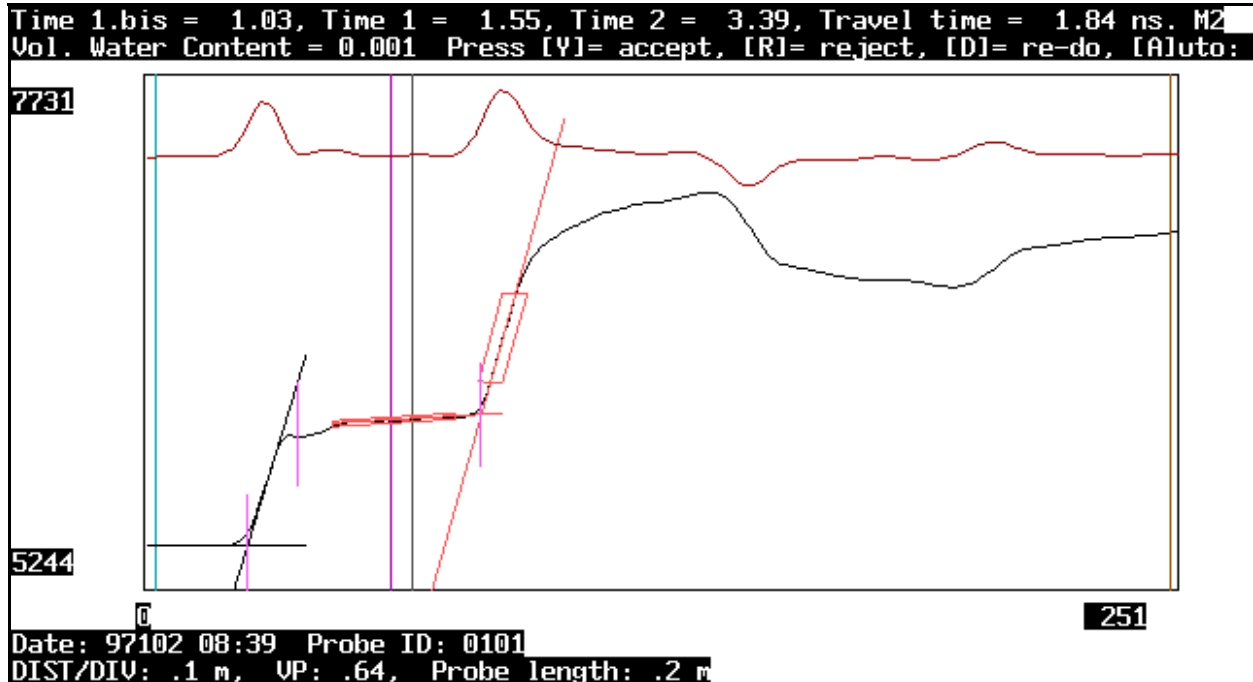

Figure 2-14. Example graphical interpretation screen for probe in dry sand.

The 'use Cursor' selection allows the user to choose the placement of t1 using a cursor moved with the left and right cursor keys.

Press 2 at the menu shown in Fig. 2-11 to change methods for finding time 2 (t2) and Fig. 2-15 appears.

[B]ase line fit, [R]ising limb fit, [I]nflection point, change [E]nding point
 for data analysis or use [C]ursor:

Figure 2-15

The '**[B]ase line fit**' refers to the method used to fit a base line to the bottom of the wave form after time 1. Two methods are available. The most commonly used is to draw a horizontal line tangent to the lowest point in the wave form after time t1. The other method is to fit a line by regression to a swath of points. The second method is recommended in most cases. After pressing B and selecting the base line fit method a '**[S]wath width**' choice will be shown. This defines the number of data points (usually 30) included in the fit. Below we'll discuss how the beginning point of the swath of points is chosen.

The '**[R]ising limb fit**' can be either a straight line fit or a polynomial fit. In the case of a polynomial fit the first derivative of the polynomial, at the midpoint of the rising limb, defines a line tangent to the rising limb analogous to the line defined by a straight line fit to the rising limb. In either case the number of points included in the fit can be set by the user so that the curved ends of the rising limb can be effectively excluded from the fit. In all cases t2 is defined by the intersection of the line tangent to the rising limb and the base line.

The 'Ending point' setting allows the exclusion of data at the end of the wave form. This is sometimes necessary for data from the analog Tektronix 1502 as noted above.

The 'use Cursor' selection allows the user to choose the placement of t2 using a cursor moved with the left and right cursor keys.

The 'Inflection point' refers to the method of finding the center of the rising limb of the wave form after time 2. Defining the center of the rising limb is necessary so a line tangent to it can be found. If the wave form is well defined, with a steeply rising second inflection (rising limb), then the first derivative will have a well defined peak centered at the midpoint of the rising limb and this point can be used to define the middle of the set of points used to fit the line tangent to the rising limb. However, if the soil is saline and wet, or very wet with a high clay content (especially high CEC clay) the wave form may have a very shallow second inflection. In this case the first derivative will not have a reliably well defined peak. The peak may be lost in noise. But, also in this case, the low point in the wave form after the first peak will always occur at the right hand side just before the second inflection. Therefore, when the second peak in the first derivative is below a certain value the low point in the wave form (local minimum) can be reliably used to index the second inflection. In this case the middle of the rising limb is taken to be a user-set number of points (30 is a good choice) to the right of the local minimum. The choices for finding the second inflection are therefore: 'Highest derivative', 'Local minimum', and 'Automatic'. The 'automatic' setting is preferred. If 'automatic' is chosen the user must specify a value of the peak in the first derivative; below which the program will use the local minimum method and above which the program will use the highest derivative method. A good choice is 6. A starting point for the search for the second peak in the first derivative is also specified to eliminate the possibility that the first peak in the first derivative or a secondary first peak (as described above) would be found. If either the automatic or local minimum method is chosen, the user specifies a number of points to the right of the local minimum to be used as the center of the rising limb.

For the algorithms described above the default settings work well with most systems. But it can be time consuming to repeatedly run TACQ.EXE to acquire wave forms and change settings. A more effective method is to set up TACQ.EXE to automatically acquire wave forms from all the probes in the system. Then, in more comfortable surroundings, the wave form file can be read back into program TACQ.EXE and the effect of algorithm changes explored without the wait for cable tester response that is inherent while acquiring data. For a more thorough discussion of the algorithms used for wave form interpretation see Section 7.

2.8 File Formats

There are four file formats used by TACQ. Three of these are shared by files that are written to during automatic data collection, and files that are created manually. The fourth is only created during manual operation of TACQ. File naming conventions differ between automatically collected files and manually collected files.

2.8.1 Automatically Collected Files

Data files created automatically by TACQ are of three kinds; files containing wave forms and associated data needed for proper interpretation of the wave forms (e.g. Vp, distance per division, distance units, probe length); files containing water contents, travel times and apparent permittivities; and files containing relative wave form voltages useful for calculation of bulk electrical conductivity. Each file type is designated by a one letter code in its file name: T for wave forms, W for water contents, and E for bulk electrical conductivity. The water content files also contain the travel times and apparent permittivities; either of which could be used in a spreadsheet to compute water contents using a calibration equation of the user's

own choosing. New files are created each day. This prevents data loss of more than a day's data if there is a power failure or system crash for some reason during file I/O. File names have the format yyyydddX.SUF where yyyy is the current year, ddd is the day of year, X is the code identifying the file type, and SUF is a file name suffix of up to 3 characters specified by the user in the Setup part of the program. Thus for a water content file containing data for day 206 of year 1994, the file name would be "1994206W.TAC" if the user had chosen "TAC" for the file name suffix. A file containing wave forms for the same day and file suffix would be named "1994206T.TAC". The user supplied file name suffix serves as an identifier to distinguish files from one TDR system from those written by another system.

Wave form files contain data for one wave form on each line. From left to right on the line the numbers are: an integer formed from the year and the day of year (e.g. 1994206 for our example); the hour, minute and seconds separated by colons (e.g. 19:01:51 for one minute, 51 seconds after 7 pm); an integer formed from the multiplexer number and probe number on that multiplexer (e.g. for multiplexer number 7 and probe 4 the number would be 0704, for probe number 16 the number would be 0716, for multiplexer number 12 and probe number 3 the number would be 1203); the propagation velocity factor; the distance per division; the units code for the distance per division (1 for feet, 2 for meters); the probe length in meters; the number of data points in the wave form; and finally, the sequential data representing the wave form from left to right on the cable tester screen. An example for 7:01:51 pm on day 206 of 1994 is:

1994206, 19:01:51, 1101 0.99 1 1 .2 251

For this example the multiplexer number was 11, the probe was connected to input number 1 on that multiplexer, the propagation velocity factor was 0.99, the distance per division value was 1 and the units were feet, the probe length was 0.2 m and there were 251 data points in the wave form (data not shown). The wave form data are Y-values (related to voltage) only. The X-values are not needed since the number of points in the wave form and the Vp and distance per division settings can be used to calculate the time interval between data points along the X-axis. For the Tektronix 1502B/C cable testers one wave form and associated data will take about 1546 bytes of hard disk space (251 data points in the wave form). Thus, a 120 Mbyte hard disk can store about 77,000 wave forms.

Water content files are formatted for easy input to a spread sheet so some numbers are in double quote marks. Each line contains data for one measurement. For the same probe used in the previous example the first line of data might look like:

1994206 19:01:47 "1101" 1.690451 2.197025 6.161919 3.964894 0.1649 8.8306

where the year and day of the year are given as one number, the time is given to seconds in 24 hour format, and the multiplexer number and probe number are in the double quoted string; followed by the time from the left hand side of the screen to t1.bis, the time to t1, the time to t2, the travel time, the water content and finally the apparent permittivity. The travel times are two-way - see Section 7.2, The TDR Method for Water Content Determination, for an explanation of the two-way travel time and how it is used to calculate apparent permittivity. Each line takes about 79 bytes so a 120 Mbyte hard disk can store over 1.5 million readings. A 1 Mbyte PCMCIA SRAM card with DOS and TACQ.EXE installed has about 530 kbytes free RAM and can hold over 6700 readings. Larger SRAM cards are also available. Our subnotebook computer can boot from these PCMCIA cards. Thus, the hard disk can be removed to make the computer data logging system completely solid state with very low power consumption (about 290 mA at 12 VDC).

BEC data files contain 9 values on each line. For example:

1994206, 20:32:12, 0101 5459.562 5655.086 5457.88 6865.02 3910.72 5440.692

The first value is a combination of the year (first 4 digits) and the sequential day of the year; the second value is the hour, minute, and second; and the third value is the multiplexer number and channel on that multiplexer. For this example the data were taken on the 206th day of 1994 at 8:32:12 pm (20:32:12 in 24 hour format) from channel 1 of multiplexer 1. The six data values are the cable tester's digital representations of the wave form voltage at various points along the wave guide. These are called V_o , V_{min} , V_o , V_f , V_i , and V_r , which are defined as follows:

- V_o The voltage of the wave form before the first peak, i.e. the pre-incident pulse height. This is taken from the regular wave form that the user sets up for determination of water content. If the first peak is set to occur just at or after the first vertical division on the screen, then this value of V_o will be the average of about 15 to 25 points. The actual number of points depends on what the program determines to be the flat part of the wave form before the first peak. This value is determined by the program for the use of some who might want to use a particular method cited in a paper. This value is somewhat noisier than the second value of V_o (see below). The second value of V_o is preferred for BEC calculations.
- V_{MIN} Again, this value is taken from the regular wave form that the user set up for determination of water content. It is the voltage of the minimum of the wave form between the first peak caused by the probe handle and the final reflection caused by the ends of the rods. Some persons have used this value for BEC calculations, but there are better methods now. It is output by TACQ for compatibility with older techniques. The value of V_{MIN} is more noisy than the others because it is a single point value, not an average. Applying more wave form smoothing will reduce the noise somewhat; but the extra smoothing may cause problems with wave form interpretation for water content. This is the only value that is taken from the smoothed wave form.
- V_o The second value of V_o is acquired by first moving the 'regular' wave form view one tenth of its length to the left (one DIST/DIV to the left), and then taking the average of the first 25 data points. These data are the first 25 data to the left of the beginning of the regular wave form that the user set up for determination of water content. Normally the two values of V_o should be the same, but the first value is slightly more noisy because of the possibility that some data from the initial part of the rise of the first peak may inadvertently be included in the averaging.
- V_F The voltage of the wave form at great distance (final voltage). To find this, the program sets DIST/DIV to 1 m or 2 feet, sets the wave form to start at 599 m or 1980 feet, and then takes the mean of the last 50 data points.
- V_I The initial voltage of the wave form before the voltage pulse is injected. This is virtual zero for the TDR system and all other voltages may be normalized by subtracting V_I from them. The program sets DIST/DIV to 0.1 m or 0.5 foot, sets the start of the wave form to -0.51 m or -2 feet, and takes the mean of the first 25 data points. The negative distance setting means that the wave form that we are looking at here is inside the cable tester, before the BNC connector on the front panel and before the pulse is injected.
- V_R This is called the relative voltage and is used in the paper by Baker et al. (1996. Agron. J. 88:675-682). It is determined from the same wave form as for V_I but is the mean of the last 25 data points of the wave form. This is in the cable outside the cable tester and after the pulse is

injected. Note that the values of V_R , the first V_O , and the second V_O are all about the same, differing only due to changes in impedance due to cable resistance, cable type before and after the multiplexer (if there is one), noise, etc. In general V_R tends to be slightly smaller than either V_O value.

For information on how to calculate BEC from these data see (among others):

Dalton, F.N. 1987. Measurement of soil water content and electrical conductivity using time-domain reflectometry. In Proceedings of the International Conference on Measurement of Soil and Plant Water Status. July 6-10, 1987, Utah State University, Logan. Vol. 1, pp. 95-98.

Dalton, F.N. 1992. Development of time domain reflectometry for measuring soil-water content and bulk soil electrical conductivity. In G.C. Topp, W.D. Reynolds, and R.E. Green (eds) Advances in Measurement of Soil Physical Properties: Bringing Theory into Practice. Soil Sci. Soc. Am., Madison, WI.

Dalton, F.N., W.N. Herkelrath, D.S. Rawlins, and J.D. Rhoades. 1984. Time-domain reflectometry: simultaneous measurement of soil water content and electrical conductivity with a single probe. *Science* 224: 989-990.

Dalton, F.N., and M. Th. van Genuchten. 1986. The time-domain reflectometry method for measuring soil water content and salinity. *Geoderma* 38:237-250.

Dasberg, S., and F.N. Dalton. 1985. Time domain reflectometry field measurements of soil water content and electrical conductivity. *Soil Sci. Soc. Am. J.* 49:293-297.

Nadler, A., S. Dasberg, and I. Lapid. 1991. Time domain reflectometry measurements of water content and electrical conductivity of layered soil columns. *Soil Sci. Soc. Am. J.* 55:938-943.

Spaans, E.J.A., and J.M. Baker. 1993. Simple baluns in parallel probes for time domain reflectometry. *Soil Sci. Soc. Am. J.* 57:668-673.

Topp, G.C., M. Yanuka, W.D. Zebchuk, and S. Zegelin. 1988. Determination of electrical conductivity using time domain reflectometry: Soil and water experiments in coaxial lines. *Water Resour. Res.* 24:945-952.

Wraith, J.M., S.D. Comfort, B.L. Woodbury, and W.P. Inskeep. 1993. A simplified waveform analysis approach for monitoring solute transport using time-domain reflectometry. *Soil Sci. Soc. Am. J.* 57:637-642.

Zegelin, S.J., I. White, and D.R. Jenkins. 1989. Improved field probes for soil water content and electrical conductivity measurement using time domain reflectometry. *Water Resour. Res.* 25(11):2367-2376.

The paper by Wraith et al. is notable for simplicity, clarity, and a method for calibration.

The load impedance, Z_L , (ohms) is used in most methods of calculating bulk electrical conductivity:

$$Z_L = Z_{REF}(1 + \rho)/(1 - \rho)$$

where Z_{REF} is the output impedance of the cable tester (50 ohms), and where

$$\rho = E-/E+$$

where

$$E- = V_F - V_O$$

and

$$E+ = V_O - V_I$$

For most methods only V_O (the second one), V_I , and V_F are needed.

4.8.2 Manually Collected Files

Three of the files created manually (e.g. by pressing F, A, S; or B; at the Main Menu) are identical in format to those created automatically; only the names differ. Wave forms are saved to a file with the WAV suffix and a user supplied prefix of up to 8 characters. For example if the user entered TEST_ONE as the prefix, the file name would be TEST_ONE.WAV. Water content files have the suffix WAT. For the TEST_ONE prefix a water content file name would be TEST_ONE.WAT. Data for bulk electrical conductivity would be in file TEST_ONE.BEC where the BEC is assigned by TACQ.

There is a fourth file type created by TACQ during manual data collection. The file name suffix is DIG and the prefix is the same as for the first 3 file types. This file contains the same wave form as in the *.WAV file. But, it is in the format used by the Tektronix program SP.EXE. It is created for compatibility with programs that use that file format. The format contains some data not saved in TACQ's other file formats, including gain and vertical offset data, and a user-supplied comment.. TACQ can read this file type.

Cables necessary to interconnect the various components of a TDR system are described here. Cable model codes appearing in this text are those assigned by the author. These codes are in many ways similar to those used by Dynamax, Inc. However, there may be differences between the cables described here and those sold by Dynamax.

TR-1058

A 50-ohm coaxial cable (RG58) is used to connect the primary multiplexer to the BNC connector of the cable tester and the primary multiplexer to secondary multiplexers. These should have male BNC connectors on both ends. A 50-ohm RG8 cable may be used, and will slightly lessen signal attenuation.

Materials:

Coaxial cable, type RG58/U, tinned braided outer conductor with at least 95% coverage, tinned stranded inner conductor. Allied product no. 708-9855, Alpha 9058AC RG58A/U coaxial cable; or Belden #8219 RG58A/U.

Male, clamp type BNC connectors. Altex part no. 9021, BNC male solder & clamp connector.

Rosin core solder, small diameter.

Attaching BNC connectors (clamp/solder type) to RG58 cable:

Place the nut, metal washer and rubber washer on the cable (Fig. 3-1 and 3-2).

Strip the end of the cable using a coaxial cable stripper (Fig. 3-3) that has been set to cut through the outer insulation on one side and the inner insulation on the other (side closest to the end). The deep cut should be about 3 mm from the cable end, while the shallow cut should be about 9 mm from the end.

Place the metal cone over the outer braid and slide until it seats against the end of the outer insulation. Then fold the outer braid over the cone, holding it in place at the end of the outer insulation (Fig. 3-2).

Twist the center conductor strands together and tin them with solder (Fig. 3-4).

Place the center pin in a vise and tin it with solder (Fig. 3-5).

Solder the center conductor into the center pin (Fig. 3-6).

Release the vise and place the body of the connector over the pin (Fig. 3-7).

Screw the nut into the body of the connector using pliers to get a tight connection (Fig. 3-8).

Repeat until all connectors are on.

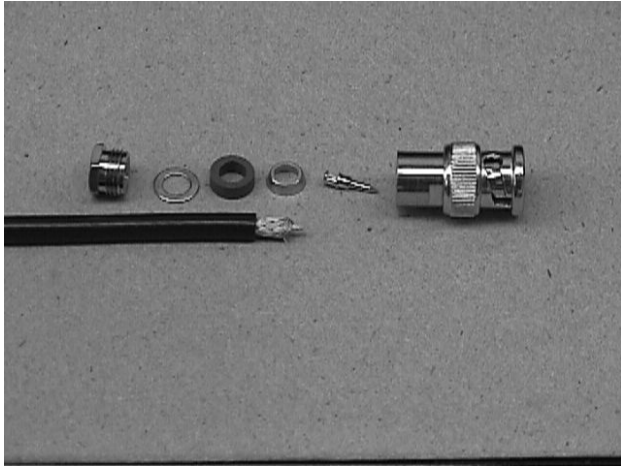

Fig. 3-1. A stripped cable end and components of the BNC connector, from left to right: nut, washer, rubber compression ring, cone, center pin, and connector body. A 3-mm long section of the cable is stripped to the inner conductor, and an additional 6-mm length has the outer insulation stripped from the outer braid.

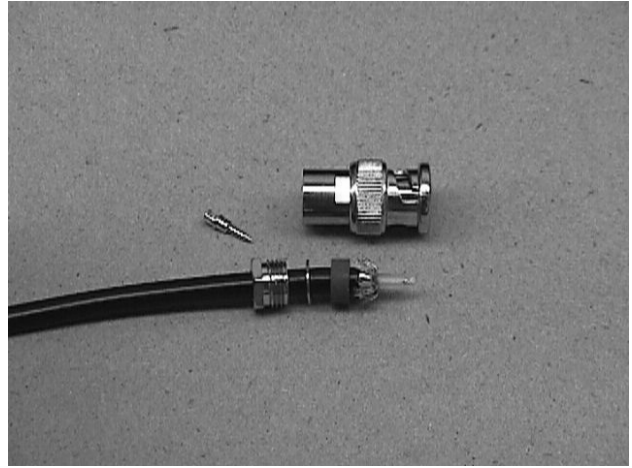

Fig. 3-2. The nut, washer, and red rubber ring have been placed on the cable. Then, the cone was placed over the braid until it seated against the cut edge of the outer (black) insulation, and the braid was folded back, covering the cone.



Fig. 3-3. A coaxial cable stripper sold by Radio Shack. The blade on the left side (visible on top of stripper in this view) is set to cut through only the outer cable insulation. The blade on the right side (not visible here) is set to cut through the outer insulation, cable braid, and inner insulation, but not through the center wire of the cable.

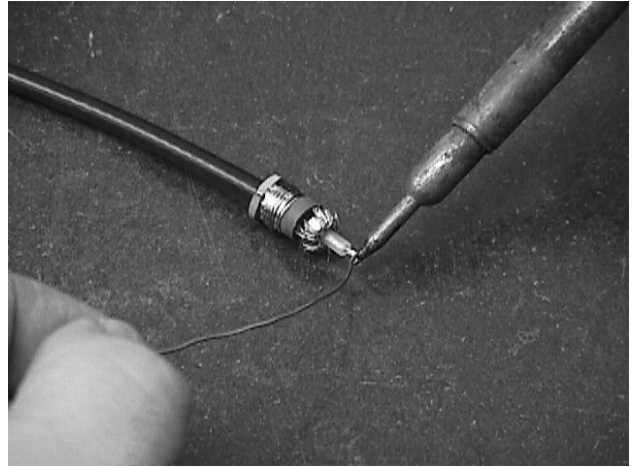

Fig. 3-4. Tinning the center conductor.

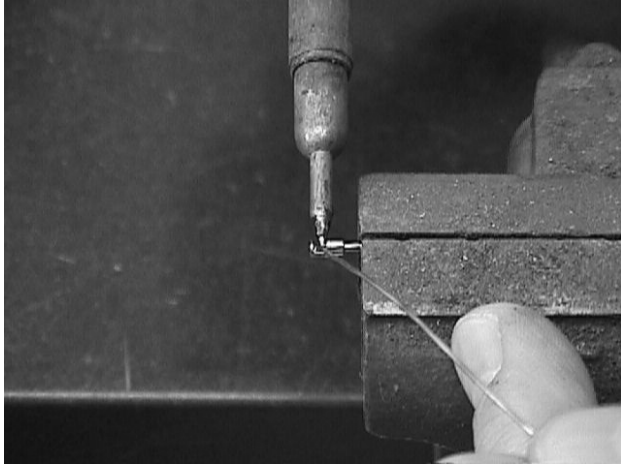

Fig. 3-5. The center pin has been secured in the vise and is being tinned.

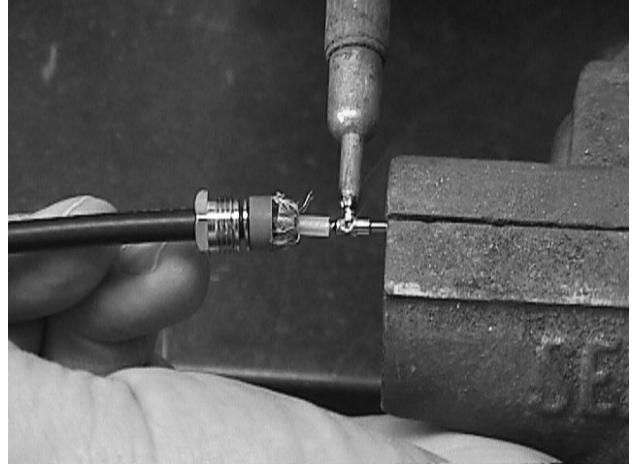

Fig. 3-6. Soldering the center conductor inside the center pin. The solder in the center pin is melted first, then the cable end is pushed into the hole in the end of the pin.



Fig. 3-7. The cable with components in place for final assembly during which the nut at left is screwed into the body at right.

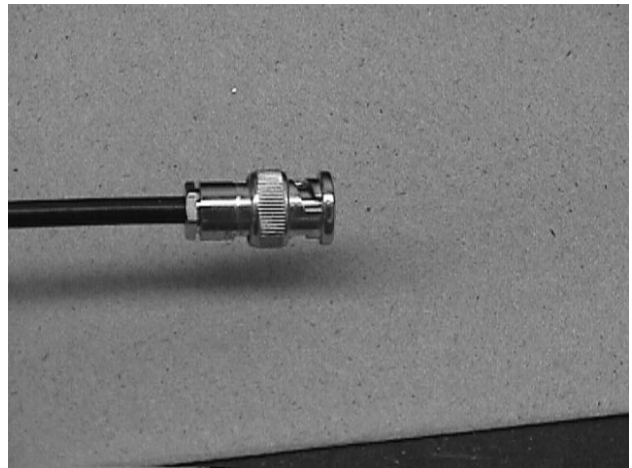

Fig. 3-8. The finished connector.

TR-2000

The most basic system requires a modem type serial cable to connect the computer and cable tester for computer control of the Tektronix 1502B/C series TDR cable tester. This shielded cable has a 9 pin female connector that plugs into the serial port of an IBM PC/AT compatible computer. The other cable end has a 25 pin male connector that plugs into the SP-232 module installed in the Tektronix 1502B cable tester. The standard 6 foot length is adequate for installations in which the cable tester and computer are housed together. A modem type serial cable may be purchased at most computer accessory outlets or can be built as indicated in the next section.

TR-2001

For computer control of the Tektronix 1502B/C series TDR cable tester in situations in which the cable tester is located a substantial distance from the computer. Like the TR-2000 this shielded cable has a 9 pin female connector that plugs into the serial port of an IBM PC/AT compatible computer. However, the conductors are 18 gage. We have tested this cable up to 150 m. At 50 m it works at all baud rates from 1200 to 19200. At 150 m it works at all baud rates up to 9600.

9 pin connector:

| <u>Number</u> | <u>Color</u> | <u>Function/Connection</u> |
|---------------|--------------|----------------------------------|
| 2 | white | RXD |
| 3 | black | TXD |
| 5 | green | signal ground |
| 7 | red | RTS |
| 8 | orange | CTS |
| 6 | blue | DSR (connected to V+ at 1502B/C) |

25 pin connector:

| <u>Number</u> | <u>Color</u> | <u>Function/Connection</u> |
|---------------|--------------|----------------------------------|
| 2 | black | TXD |
| 3 | white | RXD |
| 4 | red | RTS |
| 5 | orange | CTS |
| 6 | blue | DSR (connected to V+ at 1502B/C) |
| 7 | green | signal ground |

TR-2002

For connection between the computer's serial port and the Dynamax-modified Tektronix 1502 cable tester. This link runs at a fixed 9600 baud. A round DIN socket is mounted in the X-Y output module of the 1502 and connects internally to an analog to digital converter. A 9 pin female D-shell connector plugs into the computer's serial port.

9 pin Connector:

| <u>Pin Number</u> | <u>Color</u> | <u>Function/Connection</u> |
|-------------------|--------------|----------------------------|
| 2 | White | RXD |
| 4 | Black | DTR |
| 5 | Green | Ground |
| 7 | Red | RTS |

Switchcraft DIN plug:

Pin numbers correspond to the positions shown for the DIN socket (Fig. 3-9).

| <u>Pin Number</u> | <u>Color</u> | <u>Function/Connection</u> |
|-------------------|--------------|----------------------------|
| 1 | White | RXD |
| 3 | Green | Ground |
| 4 | Red | RTS |
| 5 | Black | DTR |

Switchcraft DIN straight cord plug type 05CL5M with 30° locking ring, 5 pins at 180°. Allied Electronics, Inc., Tel:800-433-5003, part no. 932-0154.

Switchcraft DIN socket (receptacle) type 57HA5F, for locking ring plug, 5 contacts at 180°. Allied, part no. 932-0185. See page 308 in Allied catalog no. 956.

Backside of DIN socket

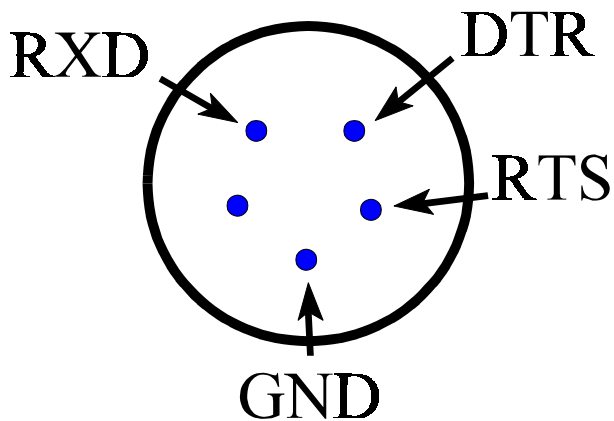

Fig. 3-9. Back side of DIN socket.

TR-2200

The TR-2200 cable set consists of a 25 pin parallel port connector from which issue three cables: TR-2200 A, TR-2200 B, and TR-2200 C. There are two situations that require the TR-2200 cable set. First, control of multiplexers requires this cable to carry both the control signals and the 12 VDC power to the multiplexer (TR-2200 B). Second, even if multiplexers are not used, the TR-2200 is required if it is desired to turn off power to the cable tester when measurements are not being made (usually desired for solar powered systems) (TR-2200 A). The power cable (TR-2200 C) connects to a 12 VDC power source. The connectors are numbered and the wires are color coded as follows:

25 pin parallel port connector:

| <u>Number</u> | <u>Color</u> | <u>Function/Connection</u> |
|---------------|--------------|------------------------------------------------------------------------------------------------------------------------------------------------------------------------------------------------------------------------------------------------------------------------------------------------------------------------------------------------------------------------------------------------------------------------------------------------------------------------------------------------------------------------------------------------------------------------------------------------------------------------------------------------------------------------------------------------------------------------------------------------------------------------------------------------------------------------------------------|
| 24 | green | Ground side of 12 VDC power cable or negative pole of 12 VDC battery; and pin 24 of PC's parallel port. There are two green wires. One goes to the 5 pin connector at the multiplexer via cable TR-2200B, and the other to the stub connector, TR-2200A. Both are soldered to the smooth (ground) side of the power cable, TR-2200C. A third short, 24 gage green wire goes from this soldered connection to pin 24 of the parallel port to provide a reference ground for control signals. |
| none | red | 12 VDC power. There are two of these. One goes to the 5 pin connector at the multiplexer and the other to the stub connector. Both are soldered to the ribbed (+12 VDC) side of the power cable and insulated with heat shrink tubing. |
| 4 | brown | SDE (serial device enable, pin 4 of PC's parallel port). This connects to pin 3 of the 5 pin connector at the multiplexer. |
| 2 | black | DATA (pin 2 of PC's parallel port). This connects to pin 4 of the 5 pin connector at the multiplexer. |
| 3 | white | CLK (clock, pin 3 of PC's parallel port). This connects to pin 5 of the 5 pin connector at the multiplexer. |
| 9 | purple | Control of DC power to TDR cable tester through the TR-302 power supply/control module (see Chapter 6). This wire goes to the stub cable, TR-2200A. Or Control AC power to cable tester through the TR-304 AC power supply/control module (see Chapter 6). When pin 9 is high then AC power is turned off; when pin 9 is low AC power is on. This allows elimination of noise that is sometimes introduced to the cable tester through the AC line. The TACQ program can turn off AC power during data acquisition (See parallel port settings in Software Setup). For this to work, the cable tester must have an internal or external battery to power it while the AC power is off. Since the noise, when present, is often on the ground line, all three AC power wires are disconnected: power, common and ground. |
| 5 | ----- | Not connected, but may be connected to a three-wire cable similar to the TR-2200A for control of power using either the TR-302 or TR-304 (see Chapter 6). |

TR-2200 A, Stub Cable Connector for cable tester DC or AC power supply/control:

This plugs into the TR-2201 cable which in turn plugs into the TR-302 or TR-304.

| <u>Number</u> | <u>Color</u> | <u>Function/Connection</u> |
|---------------|--------------|-----------------------------------------------------------------------------------------------------------------|
| 1 | purple | Power control signal , pin 9 of PC's parallel port. |
| 2 | green | Ground side of 12 VDC power supply or negative pole of 12 VDC battery; and pin 24 of PC's parallel port. |
| 3 | red | 12 VDC power. |

TR-2200 B, terminating in a 5 pin connector plug at the multiplexer:

| <u>Number</u> | <u>Color</u> | <u>Function/Connection</u> |
|---------------|--------------|-----------------------------------------------------------------------------------------------------------------|
| 1 | green | Ground side of 12 VDC power supply or negative pole of 12 VDC battery; and pin 24 of PC's parallel port. |
| 2 | red | 12 VDC power. |
| 3 | brown | SDE (serial device enable, pin 4 of PC's parallel port). |
| 4 | black | DATA (pin 2 of PC's parallel port). |
| 5 | white | CLK (clock, pin 3 of PC's parallel port). |

TR-2200 C, Power cable connector:

This is a standard plug for automobile cigarette lighter outlets. The inner pin is +12 VDC and is connected to the ribbed side of the duplex cable. The outer shell is ground and is connected to the smooth side of the duplex cable.

If you do not have a compatible 12 VDC socket, you may cut off the plug and connect the wires directly to your power supply or to another connector as may be necessary. The wire with the ribbed insulation is the +12 VDC side. This is connected to the two red wires inside the 25 pin connector. **It is not connected to the parallel port.** The wire in the power cable that has smooth insulation is the negative or ground side and is connected to the two green wires and to pin 24 of the parallel port. There is about a 0.3 VDC drop over 50 m in this cable when one multiplexer is connected and the multiplexer is switched to input 16 (highest power use). This should be a small enough voltage drop to power any multiplexing system.

TR-2201

This is a three conductor shielded cable that supplies power and a power control signal to the TR-302 power supply/control module that fits into the Tektronix 1502B cable tester; or, to the TR-304 AC power supply/control module. This cable has a three pin male plug that connects to cable TR-2200C. The other end has a three pin connector that plugs into the TR-302 or -304 module.

Connector to Stub Cable at TR-2200 end:

This plugs into the stub cable connector of the TR-2200.

| <u>Number</u> | <u>Color</u> | <u>Function/Connection</u> |
|---------------|--------------|-----------------------------------------------------------------------------------------------------------------|
| 1 | white | Power control signal , pin 9 of PC's parallel port. |
| 2 | green | Ground side of 12 VDC power supply or negative pole of 12 VDC battery; and pin 24 of PC's parallel port. |
| 3 | black | 12 VDC power. |

Connector at TR-302 or TR-304 end:

Pins numbered as seen when looking at face plate of TR-302 from left to right.

| <u>Number</u> | <u>Color</u> | <u>Function/Connection</u> |
|---------------|--------------|-----------------------------------------------------------------------------------------------------------------|
| 1 | white | Power control signal , pin 9 of PC's parallel port. |
| 2 | green | Ground side of 12 VDC power supply or negative pole of 12 VDC battery; and pin 24 of PC's parallel port. |
| 3 | black | 12 VDC power. |

TR-250

This is simply a 5 wire cable used to extend cable TR-2200B when more than one multiplexer is used. A separate length of TR-250 is used to connect each multiplexer to the end of TR-2200B. The power, ground and three control signal wires are present. Wires should be stripped 6 mm (1/4 inch) from the end and tinned. The tinned ends (distal ends) should be clamped into the five pole connectors at each multiplexer according to the table below. The proximal ends should be stripped about 20 mm from the ends and twisted together with the appropriate wire from cable TR-2200B (all wires of one color in one pigtail). Each pigtail should be soldered and insulated with PVC electrical tape or heat shrink tubing. For reliability this connection should be made inside a weather tight enclosure.

5 pin connector at multiplexer:

| <u>Number</u> | <u>Color</u> | <u>Function/Connection</u> |
|---------------|--------------|-----------------------------------------------------------------------------------------------------------------|
| 1 | green | Ground side of 12 VDC power supply or negative pole of 12 VDC battery; and pin 24 of PC's parallel port. |
| 2 | red | 12 VDC power. |
| 3 | brown | SDE (serial device enable, pin 4 of PC's parallel port). |
| 4 | black | DATA (pin 2 of PC's parallel port). |
| 5 | white | CLK (clock, pin 3 of PC's parallel port). |

INSTALLING PROBES and CABLES

Probes may be installed either by direct burial or by pushing the probe rods into the soil. The former method is straightforward. However, installation by pushing the probe into the soil requires some attention to detail in order to avoid air gaps between the rods and soil. Provided with your probes are two clear plastic spacers. Push a spacer over a probe's rod ends leaving about 2 cm of free rod. Begin to insert the probe by pushing the rod tips into the soil. When the spacer reaches the soil surface remove the spacer and continue pushing the probe into the soil until the handle makes firm contact with the soil. Pack soil around the probe handle and bury the cable. The plastic spacer will ensure that the rod spacing at the point of entry into the soil is the same as the rod spacing at the handle of the probe. As long as the probe is pushed straight into the soil no air gaps will be formed.

Burial of the cables is recommended for two reasons. First, the buried cable undergoes less diurnal temperature variation and thus the cable insulation's dielectric constant changes very little. Cables left on the soil surface may undergo wide temperature changes which induce dielectric constant changes in the cable insulation (similar to the temperature dependency of water's dielectric constant). The changing dielectric constant will cause the travel time of the TDR signal in the cable to vary and thus cause a change of position of the wave form on the cable tester screen. Under extreme conditions this can cause important parts of the wave form to shift off the screen. The second reason for burial of the cables is that buried cables are much less prone to damage by rodents or other animals, tillage operations, etc. If cables cannot be buried they can be protected somewhat from temperature extremes by wrapping with pipe insulation held in place with white tape. The pipe insulation comes in pre-slit foam tubes at most hardware stores. White tape will reflect solar radiation and thus help prevent heat buildup. The reflective Al foil tape used to install heating duct insulation can also be used to hold in place and cover the pipe insulation.

We recommend that cables be protected where they leave the soil to enter a multiplexer enclosure or other opening. This protection can be afforded by a length of 1 inch diameter polyethylene (e.g. Tygon) tubing. Slit the tubing along its length and insert the cables. Then tape the tubing closed over the cables with electrician's plastic tape.

USING THE PROBE PLACEMENT JIG

Introduction

The TDR probe placement jig (Fig. 4-1) is designed for placing probes horizontally (parallel to the soil surface). Since horizontal probe placement is most critical near the soil surface the jig provides for placement of probes at depths arbitrarily near the surface and on down to 30 cm depth. Below 30 cm horizontal placement is not so critical since in most soils water content does not change so quickly with depth below 30 cm. The jig consists of a 9 inch square base of 3/4 inch plywood which rests on the soil surface, a similar plywood backplate which is attached perpendicularly to the base, and two steel legs graduated in millimeters with centimeter enumeration which extend in the opposite direction from the backplate, i.e. perpendicular to the base and into the soil pit. Included are five 8 inch by 3/4 inch aluminum cross straps with fasteners for fixing the straps to the jig legs at the depth(s) at which probes are to be installed. Also included are a plastic square for leveling the probes and two plastic leveling guides which fit onto the 3 stainless steel probe rods.

Use

Dig a pit in the soil slightly deeper than 32 cm and wide enough to accommodate the jig legs as well as a horizontal TDR probe. Flatten the soil on one face of the pit so that it is vertical and smooth to make a smooth fit with the probe handle. Attach the appropriate number of aluminum cross straps to the jig legs leaving the top edge of each strap just below the depth at which each TDR probe is to be installed (additional straps are available if needed). Place the jig base on the horizontal soil surface just above the smooth face of the pit with the legs extending vertically into the pit. Place a weight on the jig base to hold the jig firmly in place. Attach the two plastic leveling guides to the probe rods by snapping them on. Place the ends of the probe rods on the bottom-most of the cross straps and hold the probe horizontally. Place the wide edge of the plastic square against the cross straps above the probe or against the jig back plate as may be appropriate and slide the square down to touch the leveling guides. Move the handle of the probe up or down as needed to square the probe with the jig (both leveling guides touching the bottom of the square). Slide the probe into the soil, removing the square and leveling guides as needed, until the handle is about 1 inch from the cross strap. Loosen the wing nuts on the cross strap and rotate the backing washers until the cross strap comes free from the jig legs. Remove the cross strap and push the probe into the soil until the handle comes firmly into contact with the face of the pit. Repeat this process for any other probes to be placed, moving from the bottom to the top of the pit. Moving from the bottom to the top insures that there will always be cross straps above the probe currently be installed. These are needed for the square to rest against. The bottom to top procedure also guarantees that already installed probes and their attached cables will be out of the way of probes that are to be installed later.



Fig. 4-1. The probe installation jig in use. The square is used to ensure that the probe is horizontal to the soil surface.

TR-200 MULTIPLEXER

The TR-200 16-pole coaxial multiplexer has 16 BNC female connectors around the edges, and 1 BNC female connector near the center for connection to the cable tester or another multiplexer (Fig. 5-1). It requires a 12 VDC power line and a ground line, and 3 TTL level digital lines for addressing; all of which are connected through a five pole, polarized connector (Fig. 5-1). It has been successfully controlled using personal computers. It should be possible to program the addressing (8 synchronous serial bits) using a datalogger (e.g. Campbell Sci., Inc. CR10, 21X or CR7). Data on performance of the multiplexer are reported in Evett (1998)(see addendum 1 to this text).

A five pole connector is numbered and the power and control lines should be connected as follows:

| <u>Pin no.</u> | <u>Description</u> |
|----------------|---------------------------------------------------------|
| 1 | Ground or negative pole of 12 volt battery |
| 2 | 12 volts DC power |
| 3 | SDE (serial device enable, pin 4 of PC's parallel port) |
| 4 | DATA (pin 2 of PC's parallel port) |
| 5 | CLK (clock, pin 3 of PC's parallel port) |

The parallel port pin numbers are those used in the TR-2200 cable set and are those used by programs TACQ and TR200TST.BAS to control the multiplexer. Both programs may be downloaded from <http://www.cprl.ars.usda.gov/programs> (Microsoft BASIC source code included or TR200TST.BAS). Cable TR-2200B is connected to the multiplexer. These are the default pin number assignments used in the TACQ TDR data acquisition program. They may be changed if the cable wiring to the parallel port is changed accordingly. A diagrammatic view of the top of the multiplexer is given in Figure 5-1. The 5 pole connector is at the right and is numbered 1 to 5. The 16 BNC input connectors are numbered 1 through 8 from right to left on the bottom side of the figure and 9 through 16 from left to right on the top side of the figure. Note that the computer or data logger and the multiplexer must share a common DC ground. For example, if a laptop is connected to 120 volt AC power through a wall outlet, while the multiplexer is connected to a battery, the signals from the laptop's parallel port will float in reference to the battery ground and the multiplexer will not respond to signals or will respond unreliably. The solution is to run a ground wire between pins 24 or 25 on the laptop's parallel port and the ground on the multiplexer (pin 1). If the laptop (PC, or datalogger) and the multiplexer are powered by the same source (e.g. a 12 volt battery or solar system) then the ground wire should run from pins 24-25 to the negative side of the battery. The correct grounds are implemented in the TR-2200 cable set.

The multiplexer is serially addressed using an 8 bit clocked data stream. Four bits are used to specify one of the 16 inputs and the other 4 bits are used to specify the address of the multiplexer itself. The multiplexer may be set to one of 16 addresses by moving a jumper on the back (bottom of lower of two printed circuit boards). Figure 5-2 shows the positions that the jumper may occupy, numbered by address. The jumper is set for address 1 at the factory. The address number is the decimal number that is input to subprogram LINEADDRESS in program TR200TST.BAS. Subprogram LINEADDRESS then forms a binary address that is sent through the parallel port by subprogram VAZECCONTROL.

Subprogram LINEADDRESS is also used to convert the decimal input channel number to binary for use by subprogram VAZECCONTROL in setting the multiplexer to the desired input channel. These

subprograms have been used for automatic data acquisition on a pre-set time interval in the program TACQ.EXE. Note that the multiplexer may be set to any input channel at any time. There is no requirement that the channels be used in any set order, nor do all of the 16 channels have to be used.

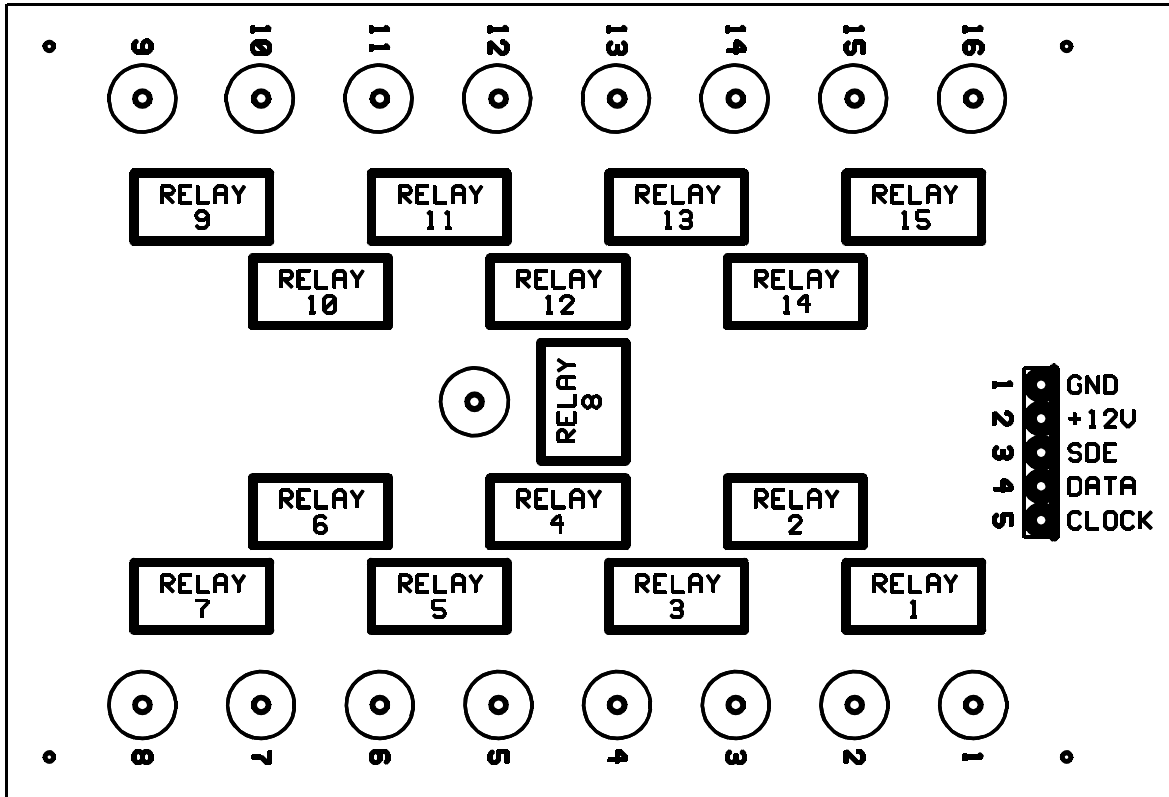

Figure 5-1. Vadose coaxial multiplexer, model TR-200, top view. Numbered concentric circles are BNC sockets, channels 1 through 16. Center BNC connector is for connection to primary multiplexer or to cable tester. Five pin, polarized power and control connector is at right.

Program TR200TST.BAS will control the multiplexer using any IBM PC/XT/AT compatible personal computer equipped with a parallel port configured as LPT1 or LPT2. Program TACQ.EXE controls the TR-200 or Cambell Scientific, Inc (CSI) multiplexers and allows automatic or manual data collection using a system equipped with a Tektronix 1502B or C connected to the PC's serial port. Alternatively, a modified Tektronix 1502 cable tester may be used. You are free to include code from program TR200TST.BAS in your own TDR data acquisition program.

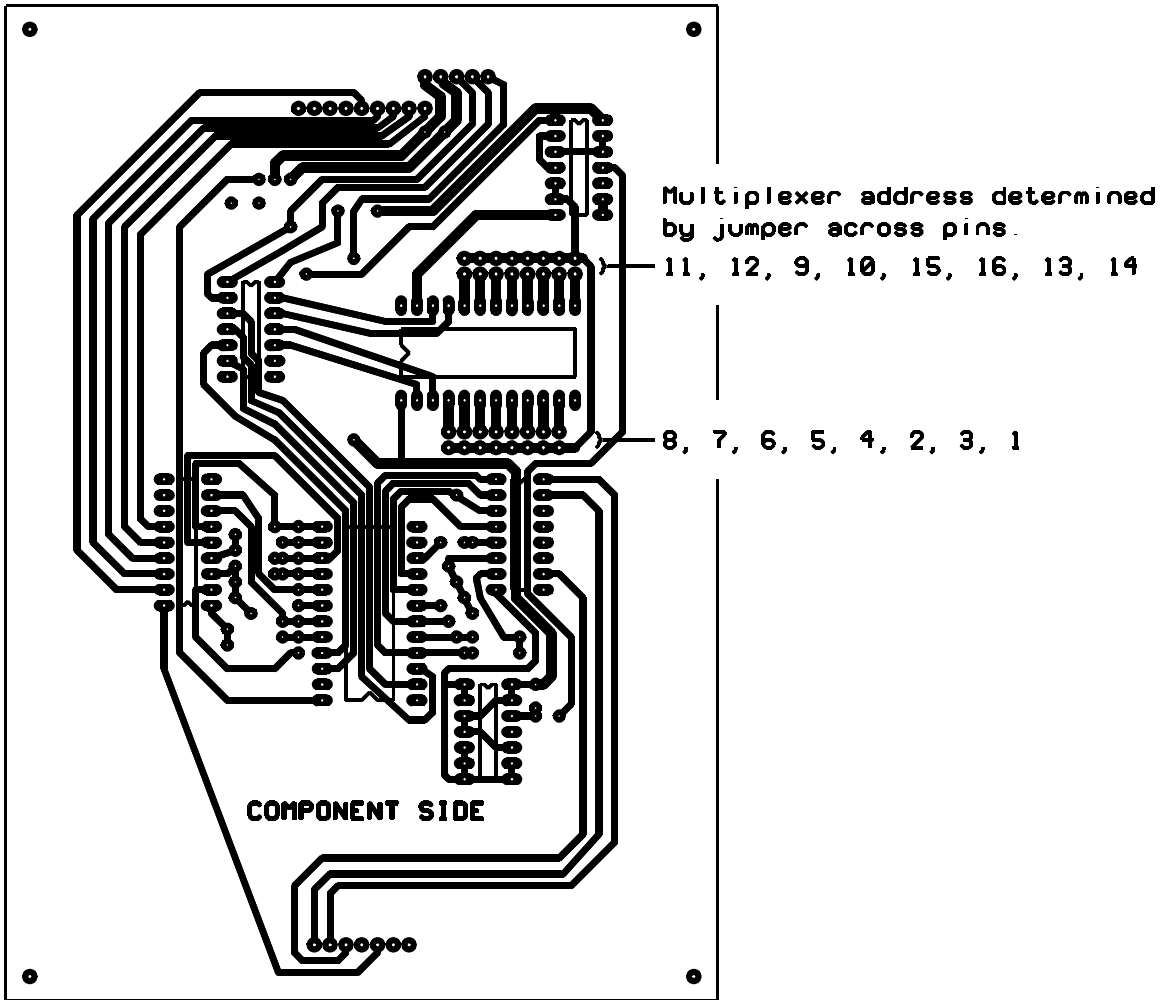

Figure 5-2. Vadose coaxial multiplexer, model TR-200, bottom view showing positions of the jumper for the 16 multiplexer addresses.

The CSI documentation for the model SDMX50 coaxial multiplexer describes the use of this multiplexer. Connections between the parallel port and the SDMX50 are similar but not identical to those described above. The connector on the SDMX50 does not have numbers, but a decal on the door of the multiplexer housing describes the connections as +12, GND, C1, C2, and C3. The connections to the parallel port are as follows:

| <u>Connection</u> | <u>Description</u> |
|-------------------|---------------------------------------------------------|
| GND | Ground or negative pole of 12 volt battery |
| +12 | 12 volts DC power |
| C1 | DATA (pin 6 of PC's parallel port) |
| C2 | CLK (clock, pin 7 of PC's parallel port) |
| C3 | SDE (serial device enable, pin 8 of PC's parallel port) |

These pin assignments are the defaults used by program TACQ. Note that the parallel port pin numbers may be changed from the default values given above for connection of the Vadose or CSI multiplexers. For example pins 2, 3 and 4 of the parallel port might be used to control the SDMX50 rather than the TR-200.

REFERENCES

Evelt, S.R. 1998. Coaxial multiplexer for time domain reflectometry measurement of soil water content and bulk electrical conductivity, Trans. ASAE 40(1):361-369.

The TDR systems described herein have been successfully powered from solar panels charging deep cycle lead acid batteries. Systems typically consist of a notebook computer, Tektronix cable tester, one or more multiplexers and attached TDR probes; all powered by 12 VDC from the lead acid batteries which are in turn charged by the solar panels. The cable tester is usually equipped with the TR-302 power control module so that the TACQ program can turn off power to the cable tester between data acquisition periods. The notebook computer's power conservation features should be enabled (this is usually done in BIOS setup) to allow the computer to turn off LCD backlighting, turn off the hard disk, and slow the clock speed while the program is not acquiring data; yet keep the CPU active so that the program can correctly time the next acquisition interval. The TACQ program is written such that it does not write to the screen between data acquisition intervals. The lack of screen activity allows the computer's power conservation features to cut in. The TACQ program also sets all multiplexers to channel 1 between data acquisition periods. Since channel 1 has the lowest power consumption (6 mA), this ensures the lowest possible multiplexer power consumption between data acquisition periods.

6.1 Power Requirements

Because the TDR system uses more power when data are actually being acquired than when the system is quiescent (waiting until the next data acquisition interval); design of the solar power subsystem is influenced by the number of probes in the TDR system, by the automatic data acquisition interval, and by the kind of data acquired. The kind of data acquired determines the time needed to acquire and store data from each probe. For instance, saving only water contents takes slightly less time than saving both wave forms and water contents, even though a wave form must be measured in both cases, because much more data is written to disk if wave forms are saved. Saving bulk electrical conductivity data takes even more time because four separate wave forms are acquired for each probe. The number of probes determines the number of multiplexers and the period of time needed for one data acquisition cycle. The acquisition interval determines the number of acquisition cycles in a day. The time required for one acquisition cycle, multiplied by the number of acquisition cycles in a day, determines the time during which the system is active. For the remaining time in a 24 h period the system is inactive or quiescent. If we know the power requirement during the active period and the power requirement during the quiescent period, plus the length of these periods, we can determine the power requirement for a 24 h period.

6.1.1 Multiplexer Power Requirements

During data acquisition, the power use by the multiplexers ranges from 6 mA for channel 1 to 101 mA for channel 16 at 12 VDC (Table 6-1, column 2). In multiplexing systems with up to 16 multiplexers, only two multiplexers are active at one time; the primary multiplexer and one second level multiplexer (See Fig. 1-2). In a 16 multiplexer system, multiplexing 240 probes,

there are 15 second level multiplexers and 1 primary multiplexer. The 15 secondary multiplexers use the first 15 channels of the primary multiplexer. Peak current on the primary multiplexer will thus be 78 mA, while peak current on any second level multiplexer will be 101 mA. Current on the non-active multiplexers at any one time will be $6 \times 14 = 84$ mA. Thus, peak current on this system will be $101 + 78 + 84 = 264$ mA. The third column in Table 6-1 gives the mean current for probes 1 through n where n is the channel number for the last channel used on a given multiplexer. [The mean current calculation assumed that each channel takes the same amount of time for data acquisition.] For the 16 multiplexer system, average current during the acquisition period will be $51 + 54 + 14 \times 6 = 189$ mA. Average current during the quiescent period will be $16 \times 6 = 96$ mA.

It is possible to connect a 17th multiplexer to the system if this multiplexer does not share the address of the primary multiplexer. Since the 17th multiplexer must share an address with one of the second level multiplexers, there will be a period during data acquisition when two second level multiplexers are switching. However, only one of these will be connected to the cable tester through the primary multiplexer at any one time. A 17 multiplexer system can multiplex up to 256 probes, but its power requirements are slightly different. During the quiescent period the current draw is $17 \times 6 = 102$ mA. The average current draw for 14/16 of the data acquisition period is $54 + 54 + 15 \times 6 = 198$ mA. The average current draw for 2/16 of the data acquisition (time when both the second level multiplexers sharing an address are on) is $54 + 54 + 54 + 14 \times 6 = 246$ mA. The average current draw for the entire data acquisition period is $198 \times 14/16 + 246 \times 2/16 = 204$ mA.

For smaller systems, current use during an acquisition period depends on the number of second level multiplexers (this determines the number of channels used on the primary multiplexer), and the number of channels used on those multiplexers. Peak and average current use can be estimated by referring to Table 6-1 for the mean current needed for the number of channels to be used and duplicating the calculations given above. For example, consider a system with 1 primary multiplexer, and 6 secondary multiplexers all of which have 16 probes attached. From the second and third columns of Table 6-1 we see that the primary multiplexer will use a

Table 6-1. Current draw when switched to different input channels.

| Current (mA) | | |
|---------------------|----------------------|--------------------------|
| Channel No. | For Chan. No. | Mean to Chan. No. |
| 1 | 6 | 6 |
| 2 | 31 | 18 |
| 3 | 31 | 22 |
| 4 | 55 | 31 |
| 5 | 31 | 31 |
| 6 | 55 | 35 |
| 7 | 54 | 37 |
| 8 | 78 | 42 |
| 9 | 31 | 41 |
| 10 | 55 | 42 |
| 11 | 54 | 44 |
| 12 | 78 | 46 |
| 13 | 54 | 47 |
| 14 | 78 | 49 |
| 15 | 78 | 51 |
| 16 | 101 | 54 |

peak current of 55 mA and a mean current of 35 mA over the course of the data acquisition period (6 channels used). The active secondary multiplexer will use a peak current of 101 mA and a mean current of 54 mA during the data acquisition period (assuming 16 channels used). Peak current to the multiplexers will be $55 + 101 + 5 \times 6 = 186$ mA. Average current during the data acquisition period will be $35 + 54 + 5 \times 6 = 119$ mA. Average current during the quiescent period will be $7 \times 6 = 42$ mA.

6.1.2 Computer and Cable Tester Power Requirements

A typical monochrome subnotebook computer uses about 500 mA at 12 VDC during data acquisition. Between acquisition periods the same computer will use about 300 mA (with hard disk and LCD backlight power management enabled). Current used by the Tektronix 1502B/C cable testers is about 1000 mA at 12 VDC. Average current draw during data acquisition will be the sum of 500 mA for the subnotebook computer plus 1000 mA for the cable tester plus the average current draw of the multiplexers (see previous paragraph). Between data acquisition periods the current draw will be the sum of 300 mA for the subnotebook, plus 5 mA for the cable tester (quiescent current of the TR-302 power control module), plus the number of multiplexers times 6 (6 mA quiescent current per multiplexer). For example, a system using 7 multiplexers would use $300 + 5 + (7 \times 6) = 347$ mA between data acquisition periods.

6.2 Length of Data Acquisition Period

The length of the data acquisition period depends on the number of probes being read, whether or not the travel times and water contents are to be found, and whether or not data for bulk electrical conductivity (BEC) calculations is to be acquired. The fastest acquisition will occur if the user has chosen to store only wave forms. Next fastest is if both wave forms and water contents are stored; and slowest is if wave forms, water contents, and BEC data are acquired and stored. It is virtually impossible to predict how quickly any given computer will be able to acquire data, but some examples are given here as guidelines.

Acquire 72 wave forms and convert to water content, saving both wave forms & water contents, 19200 baud:

| | | |
|-----------------------------------------------|---------------|----------------|
| 386SX at 16 MHz, no math coprocessor: | 19 min. | 15.83 s/probe. |
| 386SX at 16 MHz, with 387SX math coprocessor: | 12 min. | 10.00 s/probe. |
| Pentium at 133 MHz: | 6 min, 18 s. | 5.25 s/probe. |
| 486 SLC at 33 MHz: | 10 min, 49 s. | 9.01 s/probe. |

As above but with baud rate at 9600:

| | | |
|-------------------|--------------|---------------|
| 486 SLC at 33 MHz | 11 min, 7 s. | 9.26 s/probe. |
|-------------------|--------------|---------------|

Acquire 72 wave forms and save, 19200 baud:

486 SLC at 33 MHz 7 min, 25 s. 6.18 s/probe.

Acquire 72 wave forms and save only travel times, Ka and water contents:

486 SLC at 33 MHz 10 min, 16 s. 8.56 s/probe.

Acquire 72 wave forms and convert to water content, save both wave forms & water contents, acquire and save BEC data, 19200 baud:

Pentium at 133 MHz: 18 min, 41 s. 15.57 s/probe.

486 SLC at 33 MHz: 24 min, 12 s. 20.17 s/probe.

There are 3600 s per hour or 86400 s per day. Knowing the acquisition interval in seconds, we can divide it into 86400 to find the number of acquisition periods in a day. Using the data given above we can estimate the length of each acquisition period by multiplying the number of probes to be measured by the appropriate time needed for each probe (estimated from the above data considering the computer and baud rate to be used). Multiplying the number of acquisition periods by the length of each acquisition period gives the data acquisition time during a 24 h period. The remaining time is the quiescent time. Multiplying the data acquisition time (in hours) by the average current draw during data acquisition (in Amps) gives the Amp hours (Ah) needed for data acquisition. Multiplying the quiescent time by the current draw during the quiescent period gives the remaining Ah needed. Adding the Ah needed during acquisition to the Ah needed during the quiescent time gives the total Ah requirement. Multiply this by 1.2 to compensate for system losses (battery charging and discharging losses, resistive heat losses, etc.) to find the Ah per day needed from the solar panels. Note that Amp hours are not power. There is an assumed system voltage of 12 VDC. Power is measured in Watts (Joules/s). Wattage can be calculated using the formula: Watts = volts \times Amps. Also, energy is power times time. The Joule is the standard unit of energy. Another unit for energy is the Watt hour (Wh). We can calculate the daily energy requirements by multiplying the Ah requirement by the system voltage to get Watt hours (Wh).

6.3 Power Available from the Sun

Solar panels provide optimum power output only during a few hours of the day when the sun is high in the sky. These are called the peak hours. For a given location, the average number of peak hours available in a day varies with the season of the year, with latitude, with altitude, and to some extent with climate. The average number of peak hours can also be influenced by solar panel mounting, sun tracking, and concentrators. Systems that track the sun can extend the number of peak hours. Concentrators change the peak hour relationship by effectively increasing the surface area of the panel. The National Renewable Energy Laboratory (NREL) has made available on the world-wide-web solar radiation data for many stations throughout the U.S. Data

are available for flat plate and for concentrating collectors, and are available for one-axis and two-axis tracking systems as well as for systems mounted in fixed positions. Most solar systems used for remote data collection will utilize fixed mounting. The data are available at the URL <http://rredc.nrel.gov/solar/>. An example of average daily solar radiation available in December to a flat panel tilted at latitude plus 15 degrees is shown in Fig. 6-1. Note that the NREL data are in kWh/m²/day, not in peak hours. The units of kWh/m²/day are more defensible since they are standard units and peak hours are not. The concept of peak hours becomes confusing when concentrators are used. Also, note that this is solar energy available to the solar cells on the panel; not the electrical energy available from the panel. The panel electrical output will depend on the panel's overall conversion efficiency.

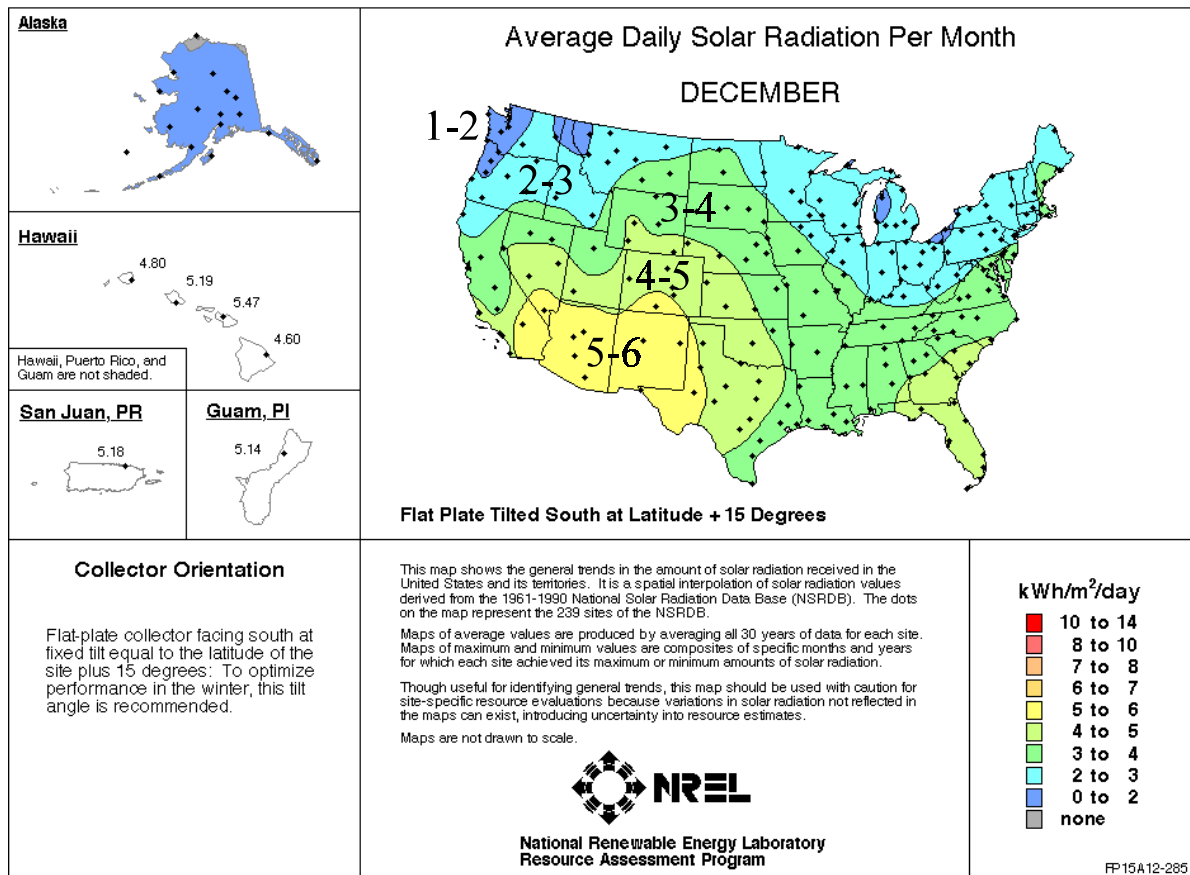

Figure 6-1 Solar radiation data from NREL.

6.4 Power Available from a Solar Panel

To find what power may be obtained from a solar panel we must know the panel's overall conversion efficiency and its surface area. Most solar cells have a conversion efficiency of about 13%; but solar panels, made of many cells, have lower efficiencies due to unused panel surface.

The overall conversion efficiency of a panel may be calculated from the panel rating, its size, and knowledge of the test conditions that prevailed when the panel rating was established. For example, a Solarex VLX-53 solar panel is rated at 53 Watts, determined under an illuminance of 1000 W/m², and has dimensions of 0.938 m by 0.501 m or an area of 0.469 m². Divide the rating in Watts by the surface area to get the rating in W/m² = 112.9 W/m². Divide the rating in W/m² by the illuminance in W/m² and multiply by 100 to get the efficiency in percent = 11.3%. The solar cells have a conversion efficiency of about 13% and the panels have only a slightly lower conversion efficiency because the solar cells cover most of the panel surface.

To use the data in Fig. 6-1 we can use the overall panel conversion efficiency to convert the daily solar radiation to power output by the panel. For example, in Amarillo, Texas the average daily solar radiation in December for a fixed panel tilted at latitude plus 15 degrees is about 4.9 kWh/m²/day. The Solarex panels would put out 0.113 × 4900 = 554 Wh/m². Since the panel has an area of only 0.469 m², a single panel would put out 260 Wh. Using the relationship W=vA, or Watts equal volts times Amps, we can convert the Wh number to an Amp hour or Ah number by dividing by the system voltage: 260/12 = 21.6 Ah.

6.5 Sizing a Solar Power System

As an example of how to configure a solar system, assume a TDR system consisting of 96 probes on six second-level multiplexers, which are in turn connected to one first level multiplexer. Also assume a notebook computer with the 486 SLC 33 MHz chip, and data acquisition every hour. Finally, assume that power to the cable tester is turned off when data is not being acquired. It takes 9.01 s/probe to acquire wave forms and water contents and save both to disk. For 96 probes it takes 96 × 9.01 × 24 = 20,760 s = 5.77 h to acquire the data. From Table 6-1 we see that the average current of the first level multiplexer (using the first 6 channels) is 35 mA during data acquisition. Also from Table 6-1 we see that the average current for one of the second level multiplexers is 54 mA during data acquisition, while the average current for the other five is 5 × 6 = 30 mA. The total average multiplexer power use during data acquisition is 119 mA. The total current for multiplexers in the quiescent period is 7 × 6 = 42 mA.

Power Consumption for a 24-h Period:

$$\text{Multiplexer during data acquisition} = 5.77 \text{ h} \times 119 / (1000 \text{ mA/A}) = \mathbf{0.69 \text{ Ah}}$$

$$\text{Multiplexer in the quiescent period} = (24 - 5.77) \times 42 / 1000 = \mathbf{0.77 \text{ Ah}}$$

$$\text{Computer during data acquisition} = 5.77 \times 500 / 1000 = \mathbf{2.88 \text{ Ah}}$$

$$\text{Computer in the quiescent time} = (24 - 5.77) \times 300 / 1000 = \mathbf{18.23 \text{ Ah}}$$

$$\text{Cable tester during data acquisition} = 5.77 \times 1000 / 1000 = \mathbf{5.7 \text{ Ah}}$$

$$\text{Cable tester in the quiescent period} = (24 - 5.77) \times 5 / 1000 = \mathbf{0.09 \text{ Ah}}$$

$$\text{Total power consumption in a day} = 0.69 + 0.77 + 2.88 + 18.23 + 5.7 + 0.09 = \mathbf{28.67 \text{ Ah}}$$

Multiplying this by 1.2 to account for losses due to charge/discharge we have a **34.4 Ah** daily power requirement. As seen in the last paragraph, in Amarillo, power from two 53-Watt solar panels should more than meet this need. These calculations show that using a low-power external timer to turn on the computer at acquisition times could save the majority of the total power used.

The solar power system is not complete without battery storage. The above calculations assume an average of 4.1 kWh/m²/day solar energy available. There may be cloudy periods during which the energy available is much less than this for several days. In a conservative design battery, capacity must be large enough to keep the system running for several days - up to 10 days in critical applications. Multiplying our 34.4 Ah daily power requirement by 10 we see we need at least a 344 Ah battery. To protect against discharging the battery too much we divide by 0.6 to get a 573 Ah battery capacity. This may be provided by a battery bank of one or more deep cycle lead acid batteries. To protect the battery bank from overcharging, a charge controller must be used between the solar panel(s) and battery bank.

The design example just provided used some simplifying assumptions. For example, it was assumed that the worst case for available solar radiation would be in December and that the panel should be tilted at latitude plus 15 degrees to enhance wintertime radiation capture. In some locations the worst case design might use data from another period of the year when local climate produces cloudy conditions that minimize solar irradiance. For more complex systems a good starting place is "Stand-Alone Photovoltaic Systems: A Handbook of Recommended Design Practices", Sandia National Laboratories, no. SAND87-7023. Available from NTIS, U.S. Dept. Of Commerce, 5285 Port Royal Rd., Springfield, VA 22161. Also helpful is the freeware computer program PVsize, available from the Energy Efficiency and Renewable Energy Clearinghouse (EREC), P.O. Box 3048, Merrifield VA 22116, tel. 800.363.3732 or by browser at <http://erecbbs.nciinc.com>, or through their BBS at 800.363.3732.

6.6 Cable Tester Power Control with the TR-302 Power Control Module

Considerable power savings may be attained by switching off power to the Tektronix cable tester when it is not in use. This may be accomplished by designating a pin of the computer's parallel port to signal power on (logic high) and power off (logic low) to the optional TR-302 power control module installed in the cable tester (1502B only). The Campbell Scientific model TR-302 installs in the space at the rear of the cable tester normally reserved for the removable battery pack. The pin used is normally pin 9 and this is the pin used in the TR-2200 cable set. But any pin from 2 to 9 may be used provided it is not designated for other use, and the user is willing to build a cable or rewire the TR-2200. See the documentation for program TACQ.EXE for details on designating the pin number. The TR-302 is connected to the computer, and to 12 VDC power, using cable TR-2200A of the TR-2200 cable set. A polarized connector on the TR-2200A ensures correct connection. The TR-302 is clearly marked for wires carrying 12 VDC power, ground, and the control signal from the parallel port. Be sure that a common ground exists for the computer and cable tester. See section 6.9 for alternative hardware for controlling 12 VDC power.

Program TACQ.EXE controls the power automatically. Power is on when the user is at the main menu of the program or in software setup; but is turned off when the program is in the automatic data acquisition mode until measurements start. When measurements begin, the computer provides a 5 VDC signal to turn on power. The computer waits for a short period (user designated in software setup, but usually 5 s) to allow the cable tester to self-initialize before beginning RS-232 communications. When measurements are finished the computer sets the pin

low, turning off power to the cable tester until the next acquisition interval. We recommend that this feature be used for systems that rely solely on battery power and/or solar power. If adequate power is available, we recommend that this feature not be used since switching the cable tester on and off carries the risk of cumulative damage to its electronic circuitry.

6.7 Cable Tester Power Control with the TR-304 AC Power Control Module

With a cable tester powered from an AC line, it sometimes happens that the wave form becomes noisy because of noise in the AC power. If the cable tester has an internal battery, the TR-304 AC Power Control Module may be used to switch off AC power during the data acquisition period, switching AC power back on to recharge the battery when data acquisition is finished. Unless the duty cycle of data acquisition approaches 100% this is a good solution to the noise problem. It is especially useful when the Tektronix 1502C cable tester is used, since this cable tester has no opening in its case for the TR-302 Power Control Module, precluding the easy use of regulated and isolated DC power. The TACQ software allows a pin of the parallel port to be dedicated to controlling the TR-304. If pin 9 is not used to control a TR-302 module, then pin 9 may be used; otherwise pin 5 is usually available as well. If the TR-2200 cable set is used, then the TR-2200A stub cable (with optional TR-2201 extension cable) may be plugged into the TR-304 AC module. In this case, pin 9 should be specified to control AC power, since pin 9 is the parallel port pin that is wired to the TR-2200A stub cable.

Note that the action of the TR-304 AC module is the opposite of that of the TR-302 module. During data acquisition the TR-302 turns on DC power to the cable tester; while for the TR-304, AC power to the cable tester is turned off during data acquisition. All three AC power wires are disconnected when power is off; the power, common, and ground wires. It is necessary to disconnect the ground wire because the noise is often on the ground. Noise problems of this sort are usually found in outdoor applications where AC power grounding is not the best.

6.8 Connect External 12 VDC Power to the 1502C TDR Cable Tester

The Tektronix model 1502C TDR cable tester was originally conceived as a commercial variant of the model 1502B, which was a military specification unit. Unlike the 1502B, it did not have a recess in the back of the case for a removable NiCd battery pack. It did have an option for an internal lead acid battery (12 VDC) and the uppermost power supply PCB has a four-pin in-line header for connecting the battery. The two outside pins are for ground and connect to the chassis; while the two inside pins are for +12 VDC. After the 1502B was discontinued, Tektronix revised the options for the 1502C and made available an option with the case recess and banana plug connectors to accommodate the removable NiCd battery pack. If bought with this option, the 1502C may be used, as was the 1502B, with the Campbell Scientific, Inc. (CSI) model TR302 power supply module to turn 12 VDC power on and off to the cable tester. This section is intended to help those who have a 1502C without the removable battery pack option (the majority of 1502Cs in service) to wire that cable tester for external 12 VDC power and to control that power. Note that these modifications may invalidate the manufacturer's warranty.

The most straightforward modification is to run a two wire cable through a hole in the back of the case (Fig. 6-2). Put a polarized connector on the cable to help avoid reversing the polarity. The cable must be long enough that the case can be removed from the chassis with the connector on the end of the cable (Fig. 6-3). Some care is required when replacing the case to avoid crimping the cable between the case and chassis. The cable should be terminated in a four position female in-line connector (0.1 inch spacing) with the two outer sockets connected to ground, while the two inner sockets are connected to +12 VDC (Fig. 6-4). The terminated cable may be plugged into the in-line header on the power supply PCB (Fig. 6-5). Before applying power, check that the ground side of the polarized connector has a closed path to the chassis; and check that the +12 VDC side of the polarized connector has a closed path to both of the inside pins on the power supply PCB, and no path to the chassis.

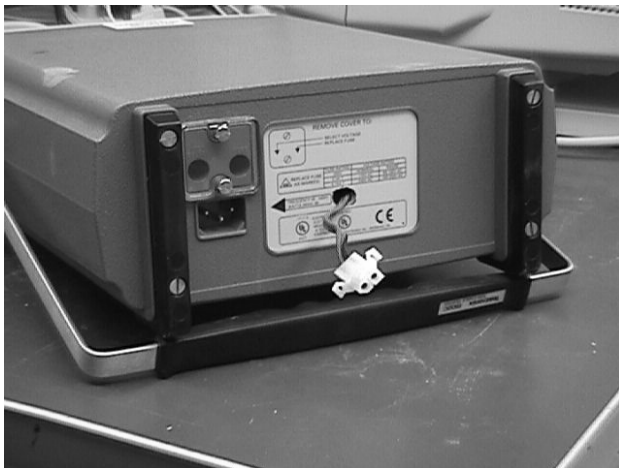

Figure 6-2 DC power cord, with polarized nylon connector, emerging from a hole drilled in the back of the case for a Tektronix 1502C TDR cable tester.

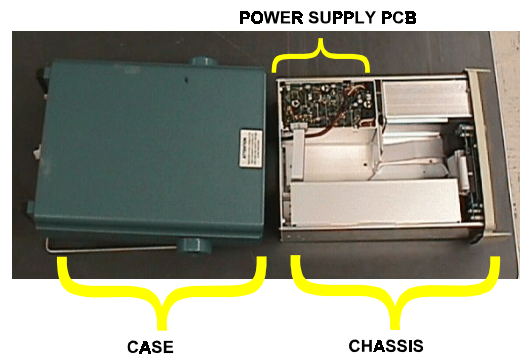

Figure 6-3 Tektronix 1502C TDR cable tester with case (at left) removed far enough to allow access to the power supply printed circuit board.

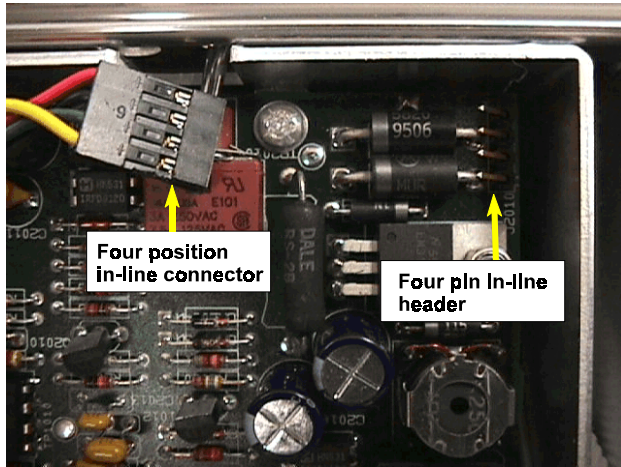

Figure 6-4 Close up view of power supply printed circuit board in model 1502C cable tester. The four position connector will be placed on to the header to complete the connection of an external 12 VDC power source.

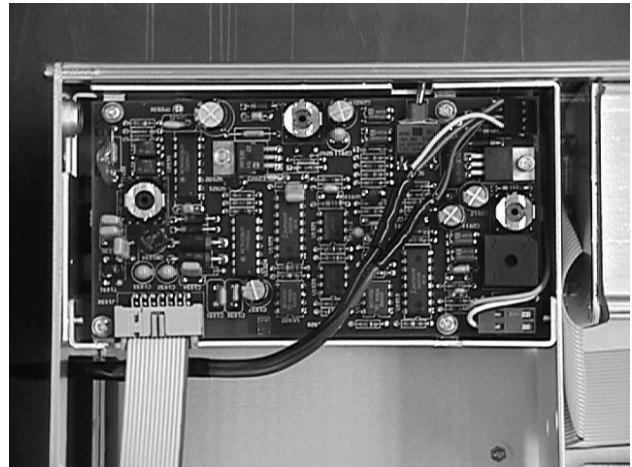

Figure 6-5 View of power supply circuit board in model 1502C cable tester with external power connected to four pin in-line connector. The two outer pins are connected to the ground side of the two-conductor cable.

The 12 VDC power supply should source enough current to allow the cable tester to power up without a low voltage fault. The Tektronix cable testers check for a low voltage condition at power-on. If the supply will not source enough current to prevent a dip in voltage at power-on then the cable tester will detect the dip as an out-of-range voltage and will not come on. For this reason, some AC-DC inverters will not allow the cable tester to reliably turn on. Because lead acid batteries source current very well, even a small 12 VDC lead acid battery will reliably turn on these cable testers.

6.9 Control 12 VDC Power to the 1502C TDR Cable Tester

If the CSI model TR302 power supply module cannot be used, we can control power with a simple Darlington transistor pair driving a relay and triggered by a TTL level signal (Figs. 6-6 and 6-7). Pin 9 of the computer's parallel port can be used to provide the TTL signal at the I/O pad (Fig. 6-6). Cabling can be similar to that used for the TR302. The three wires needed in the cable carry +12 VDC, ground, and the TTL signal, respectively. Spacing for the I/O, GRND, and +12 circuit pads is 0.2 inch (Fig. 6-6), which is compatible with many screw terminal strips. If a Wieland type 8213S/3WOB horizontal socket is used here, then the 3 pole Wieland 8213B/3 screw terminal plug may be used to terminate the cable carrying I/O, ground, and +12 VDC. This is compatible with the plug used with the TR302. Note that the circuit shown in Figures 6-6 and 6-7 is not optically isolated, has no fuse, is not diode protected against reverse polarity connections, and is not protected against transients with a MOV. The specified relay could probably be replaced with one rated for less current and voltage, but has proven reliable. The circuit draws from 30 to 40 mA at 12 VDC. A much lower power circuit could be designed using a small solid state relay and an optoisolator.

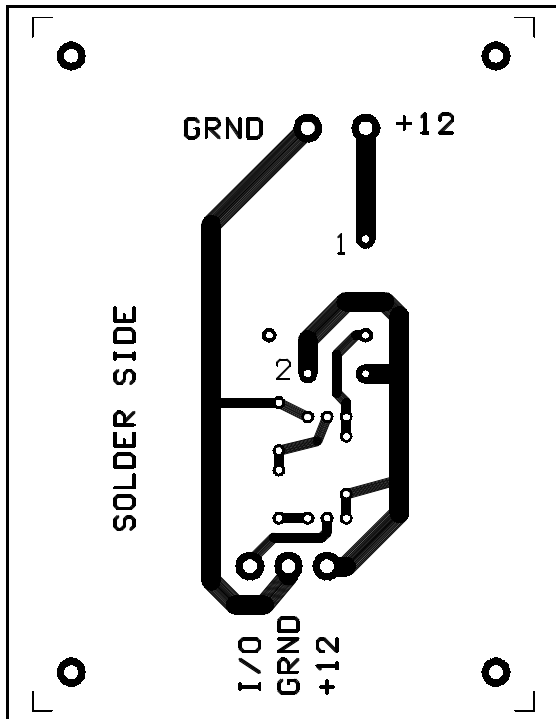

Figure 6-6 Solder side of circuit board for controlling power to the 1502C cable tester. The ground and +12 VDC pads at the top of the figure should be connected to the power supply PCB of the cable tester as described in the text. The I/O, ground, and +12 VDC pads at the bottom are for connection to pin 9 of the parallel port, the ground (negative side of the battery), and +12 VDC side of the battery, respectively.

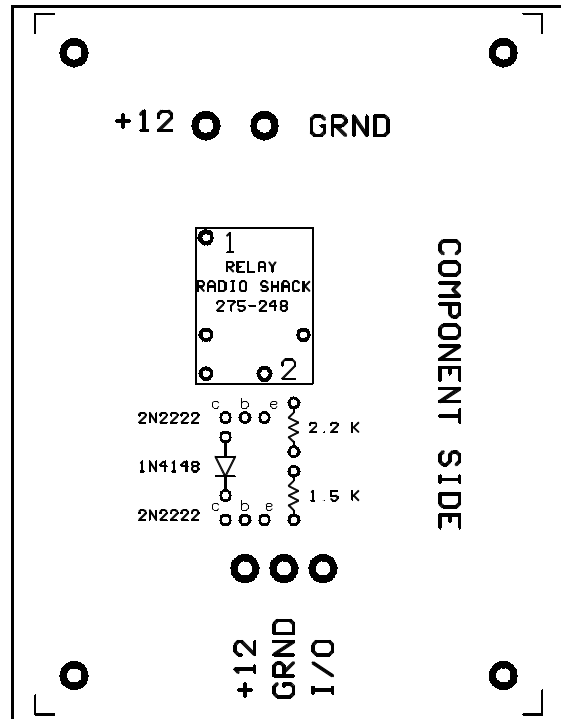

Figure 6-7 Component side of circuit board for controlling power to 1502C cable tester. The 2N2222 transistors are common NPN transistors. The 1N4148 is a common switching diode. The Radio Shack relay is made to be powered from 12 VDC. The normally open circuit in the relay is from pin 1 to pin 2. The coil resistance is about 400 ohms, and the contacts are rated at 10 A at 120 VAC.

Figures 6-6 and 6-7 are only approximately to scale. The apexes of the corner marks should be 2.6 inches apart horizontally, and 3.6 inches apart vertically. The circuit is single-sided and can be built using only the traces and pads shown in Fig. 6-6. The Gerber file for Fig. 6-6 is 1502CT-1.001, the aperture file is 1502CT-A.001, and the numerical control drill file is 1502CT-D.001. All three files may be downloaded from <http://www.cprl.ars.usda.gov/programs>

7 PRINCIPLES and METHODS for TIME DOMAIN REFLECTOMETRY

7.1 Introduction

Time domain reflectometry (TDR) has become increasingly popular for the determination of soil water content. The technique depends on the measurement of the travel time of an electronic pulse through a wave guide (also called a probe) inserted in the soil. Topp et al. (1980) and other early researchers determined travel times in TDR probes by fitting tangent lines to wave form features by hand, either reading directly off the instrument screen or working with photographs of the screen. Since then, automatic wave form acquisition systems have been created that allow the collection of thousands of wave forms (Baker and Allmaras, 1990; Heimovaara and Bouten, 1990; Herklerath et al., 1991; Evett, 1993, 1994), thus necessitating the creation of computer programs for automatic interpretation of the wave form to find travel times. Several impediments have been encountered. Wave forms acquired in the field are often not as reproducible as those found in the laboratory. Wave form shape can change depending on probe construction or installation. Wave form shape varies quite dramatically with soil water content, bulk density, and salinity changes in the soil over time; with clay content changes between horizons and across the field; and with noise caused by various external factors or the data acquisition system itself. Since 1991 a set of algorithms was developed, field tested, and improved, leading to a reliable computer program for real time, unattended determination of travel times from TDR wave forms.

7.2 The TDR Method for Water Content Determination

The TDR method depends on the change in apparent permittivity of the soil which occurs when soil water content changes. The permittivity of the mineral matter in soil varies between 3 and 5. The permittivity of air, which may take up as much as 45% of the soil volume, is negligible. By contrast, the permittivity of water is about 80 (depending on temperature). As soil wets and dries its apparent permittivity, ϵ_a , changes accordingly, though not in a linear fashion. For four fine textured mineral soils, Topp et al. (1980) found that a single polynomial function described the relationship between ϵ_a and volumetric water content, θ :

$$\theta = (-530 + 292 \epsilon_a - 5.5 \epsilon_a^2 + 0.043 \epsilon_a^3)/10^4 \quad [1]$$

Commonly, implementation of the method employs a Tektronix TDR cable tester which was designed to find the location of faults in a cable. The cable tester consists of an electronic function generator which outputs a square wave signal with a very fast rise time (120 ps) and an oscilloscope timed to the square wave. The vertical axis of the oscilloscope screen has units of voltage while the horizontal axis has units of distance along the cable (or other waveguide). The units of the horizontal axis are set using the distance per division (DIST/DIV) setting. The horizontal axis is divided into ten divisions so that if DIST/DIV is set, for example to 0.2 m then the entire screen width represents 2 m.

The cable tester also has a setting for the relative propagation velocity, V_{pr} . This is the ratio of the velocity at which the signal propagates in a cable or other waveguide, v , to the velocity of light in a vacuum, c_0 . The propagation velocity depends on the permittivity, ϵ , and the magnetic permeability, μ :

$$v = c_0(\epsilon\mu)^{-0.5} \quad [2]$$

The permittivity of different insulations is different and the velocity of the signal changes accordingly. For example, for polyethylene insulation the velocity of the signal is about 0.66 times c_0 so the relative propagation velocity is 0.66. The magnetic permeability is usually assumed to be unity.

It is important to understand that the oscilloscope measures time not distance. Therefore, in order to display distance on the horizontal axis of the screen the cable tester internally converts measured times to distances. The propagation velocity, v , is used to make the conversion. If the relative propagation velocity, V_{pr} , is set to 0.99 then the assumed propagation velocity is correspondingly:

$$v = 0.99 c_o = 0.99 \times 0.299792 \times 10^9 \text{ m/s} \quad [3]$$

To convert from time to distance, the cable tester uses this assumed value of v and the measured time in the following equation which relates the one-way distance, d , to the one-way travel time, t :

$$d = vt \quad [4]$$

On the cable tester a 'Distance' knob allows the user to change the delay between signal propagation and oscilloscope scan. This delay amounts to the time that it takes the signal to travel a given distance down the cable and back to the oscilloscope pickup. Thus, the user can adjust the screen to show portions of the signal being reflected from different distances down the cable. Again, the cable tester uses the propagation velocity that we have chosen to convert the delay time to distance units so that the 'Distance' dial shows the correct distance. The distance will only be correct if we have chosen the correct relative propagation velocity. The signal trace on the oscilloscope screen will be flat except where discontinuities in the cable cause impedance changes and a partial reflection, or loss, of the signal. Reflections are caused by increases in impedance such as an open or broken conductor while signal loss is caused by decreases in impedance such as a short to ground.

For a cable the propagation velocity is known because the permittivity of the insulation is known. Therefore the time, required for the signal to travel to an impedance change and back again, can be used to calculate the distance to the impedance change. In the soil the apparent permittivity is unknown. However, we can construct probes (waveguides) which cause two impedance changes at a known distance from each other in the soil. Then we can use the cable tester to measure the time for the signal to travel from one impedance change to the next and use Eq. 2 to calculate the apparent permittivity which is the basic datum needed to calculate water content from Topp's equation. If t_i is the two-way travel time measured by the oscilloscope for the signal to travel from one impedance change to the other and back again, and L is the distance between the impedance changes then $v = 2L/t_i$. Substituting this into Eq 2, assuming $\mu = 1$, and rearranging we can calculate the apparent permittivity, ϵ_a :

$$\epsilon_a = [c_o t_i / (2L)]^2 \quad [5]$$

Our problem is now reduced to finding the travel time, t_i , give the trace from the cable tester screen for a probe of known length, L . Note that we do not have to know the actual propagation velocity to get the correct value of t_i from the cable tester. We only have to know the propagation velocity factor that was set on the cable tester, when the wave form was measured, in order to convert the distance units reported by the cable tester back to time units by inverting Eq. 4.

A prototypical TDR signal from a 2 wire TDR probe constructed for water content measurements is shown in Figure 7-1. When the square wave signal reaches the point where the coaxial cable is connected to the rods a partial open circuit occurs because the outer braid is pulled away from the inner conductor. This partial open represents an increase in impedance which causes a reflection (increase in voltage) of the signal just before point t_1 (Fig. 7-1). Immediately after passing through this partial open the signal leaves the insulating handle of the TDR probe and enters the rods buried in the soil. The moist soil causes a partial closed circuit (partial short circuit) compared to the handle and the signal voltage decreases (wave form height decends). The sudden increase and then decrease in reflected wave form height as the signal passes through the probe handle and into the soil causes the peak in wave form height at point t_1 . As the signal passes through the rods buried in the soil it typically encounters only small changes in permittivity and conductor configuration so no reflections are seen. This is shown in the low and flat part of the signal between points t_1 and t_2 . When the signal reaches the ends of the rods in the soil it encounters an open circuit and is strongly reflected causing the increase in wave form height shown at point t_2 in Figure 7-1.

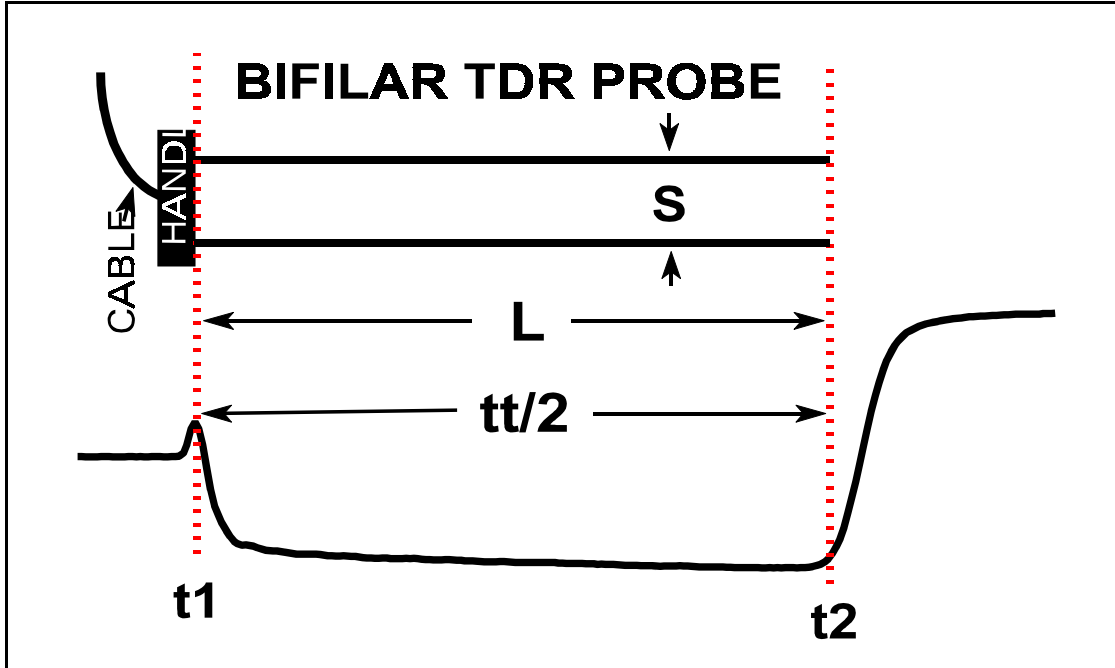

Figure 7-1. Relationship of TDR probe parts (top) to wave form features (bottom) for moist sand. For the wave form, the vertical axis has units of voltage and the horizontal axis units of time. The distance S is the rod spacing, L is the rod length, $tt/2$ is the one-way travel time, t_1 is the time when the step pulse exits the probe handle to travel down the rods, and t_2 is the time when the pulse reaches the ends of the rods and is reflected back.

If we measure the distance units along the horizontal axis between points t_1 and t_2 and convert the distance to time we can use this travel time in Eq. 5 to calculate the soil's apparent permittivity and use this value of ϵ_a to calculate the water content using Topp's or a similar calibration equation. For example, if we have set the DIST/DIV to 0.5 ft/division then, knowing that there are ten divisions across the screen we calculate that the horizontal axis represents 5 ft of distance from the leftmost division to the rightmost division. Furthermore, knowing the value of v that we have set in the cable tester we invert Eq. 4 to calculate the one-way travel time, t , represented by the horizontal axis:

$$t = d/v \quad [6]$$

or, for a relative propagation velocity of 0.99:

$$t = [5 \text{ ft} \times 0.3048 \text{ m/ft}] / (0.99 \times 0.299792 \times 10^9 \text{ m/s}) \\ = 5.13 \text{ ns} \quad [7]$$

If we have measured the position of points t_1 and t_2 in units of screen divisions we need only divide t by 10 and multiply by the number of divisions to first, point t_1 , and then point t_2 to find the travel times to these points. If we have measured the difference between points t_1 and t_2 in distance units we can enter the distance directly into Eq [6] (This is easy with the newer digital TDR cable testers). However, we note that the signal must travel twice the distance in order to go from point t_1 to point t_2 and back to point t_1 . The distance given on the horizontal axis of the screen is the one-way distance and so is the corresponding time. We must multiply by two to find the two-way travel time:

$$t_t = 2d/v \quad [8]$$

Using Figure 7-1 as an example and counting screen divisions from the left hand side, we see that point t1 is at 1.1 screen divisions and point t2 is at 6.7 screen divisions, the difference between point t2 and point t1 being 5.6 screen divisions. Multiplying 5.6 by 0.513 ns per division gives 2.87 ns for the travel time from point t1 to point t2. Because the signal must travel from point t1 to point t2 and back again we multiply this travel time by 2 to get the full travel time $t_t = 5.75$ ns. Using Eq 5 and the probe length of 0.2 m we calculate $\epsilon_a = 18.6$ and using Eq 1 we calculate $\theta = 0.33$ which is a reasonable value for a well graded and packed saturated sand. Equivalently, we may multiply the difference in screen divisions between points t1 and t2 (5.6 divisions) by the distance per division which is $[5 \text{ ft}/(0.3048 \text{ m/ft})/10] = 0.1524$ m. We calculate $d = 0.853$ m and using this value in Eq 8 we calculate a travel time of $t_t = 5.75$ ns which leads to a water content of 0.33 as before.

7.3 Description of wave form features as related to the TDR probe

The most basic TDR system consists of a pulse generator providing a step increase in voltage with a very fast rise time (typically 150 ps) and a fast oscilloscope that captures the wave form reflected from an attached cable or other waveguide (Topp et al. 1980). A TDR cable tester such as the Tektronix 1502 provides the pulse generator and oscilloscope in a tightly integrated unit. Note that although the cable tester gives distance as the units of the horizontal axis it really measures time. The cable tester may be adjusted to display on its screen any portion of the wave form including that part showing reflections from a probe installed in the soil.

Consider a TDR probe consisting of two stainless steel rods buried parallel to one another in a moist sand (non-saline) with the proximal ends soldered to coaxial cable (Fig. 7-1). The soldered connections are potted in epoxy. We will call the ensemble of epoxy potted connections the probe handle. The perpendicular distance between the rods is the separation distance, s , and the exposed length is L . Typically the coaxial cable would have a characteristic impedance of 50 ohms. A prototypical TDR wave form shows the reflections caused by the various parts of such a probe (Fig. 7-1). In particular, we are interested in the time necessary for the pulse to travel along the exposed length of the stainless steel rods, i.e. the one way travel time, $tt/2$.

The voltage level of the wave form at any time is representative of the impedance of the wave guide (cable or probe) at the corresponding physical location. Impedance has units of ohms but is a combination of resistance and inductance. Consider the coaxial cable leading to the probe. The cable features a very good insulator between the inner and outer conductors. For any length of the cable with uniform characteristics the voltage level of the line is unchanging except for a slight upward trend with increasing distance from the cable tester. Since the wave form level is representative of the impedance of the cable we expect the slight upward trend since the total resistance increases with cable length. If the characteristic impedance of the wave guide changes, this will cause partial reflections of the pulse. The sign of the reflections is determined by the sign of the change in impedance. If impedance increases the reflection is positive and the wave form level increases. If the impedance decreases the wave form level decreases corresponding to a negative reflection. The impedance, Z (ohms), of a transmission line (i.e. waveguide) is

$$Z = Z_0(\epsilon)^{-0.5} \quad [9]$$

where Z_0 is the characteristic impedance of the line (when air fills the space between conductors) and ϵ is the permittivity of the (homogeneous) medium filling the space between conductors. For our parallel transmission line (the two rods in the soil) the characteristic impedance is a function of the wire diameter, d , and spacing, s (Williams, 1991):

$$Z_0 = 120 \ln\{2s/d + [(s/d)^2 - 1]^{0.5}\} \quad [10]$$

or, if $d \ll s$:

$$Z_0 = 120 \ln(2s/d) \quad [11]$$

while for a coaxial transmission line the characteristic impedance is:

$$Z_0 = 60 \ln(D/d) \quad [12]$$

where D and d are the diameters of the outer and inner conductors, respectively. From Eqs. 9 through 12 it is apparent that impedance, Z, increases as wire spacing increases and decreases as ϵ (water content) increases for any probe type.

The permittivity for a homogeneous material is defined for propagation of a sine wave as

$$\epsilon = \epsilon' - j(\epsilon'' + \sigma_{dc}/\omega\epsilon_0) \quad [13]$$

where ϵ' and ϵ'' are the real and imaginary parts, respectively, σ_{dc} is the direct current conductivity, ω is the frequency of the wave, ϵ_0 is the permittivity of free space, and j is the square root of minus one.

Measurement of soil water content by TDR is based on the fact that the propagation velocity of an electromagnetic wave is given by (assuming $\mu = 1$)

$$v = c(\epsilon)^{-0.5} \quad [14]$$

where c is the speed of light in free space. If $\epsilon' \gg \epsilon''$ then

$$v = c(\epsilon')^{-0.5} \quad [15]$$

and v is very nearly solely dependent on water content. If a Tektronix cable tester is used to measure the travel time, tt, this time is the two way travel time; and the velocity is $v = 2L/tt$. The value of permittivity calculated using the measured v and Eq. 14 or 15 includes both real and imaginary parts and is an apparent permittivity, ϵ_a . The volumetric water content can be related to ϵ_a as did Topp et al. (1980) using a polynomial regression, or directly to t_t in which case the relationship is closely linear.

The base line before the first peak in the wave form (Fig. 7-2) is the flat line to the left of the reflections caused by the probe. This preincident base line corresponds to the cable connecting the probe to the cable tester and the level of the base line corresponds to the impedance of the cable as described by Eqs. 9 and 12. At the connection between the cable and the proximal ends of the probe rods the cable is typically split (at t1.bis in Fig. 7-2) into two separate conductors with the outer braid of the coaxial cable twisted into a stranded wire that is connected to one stainless steel rod, and the inner conductor of the cable connected to the other rod. For trifilar probes, the outer braid is connected to the two outer rods and the inner conductor is connected to the middle rod.

Regardless of the probe type, at the connection point there is a widening of the separation between the conductors of the cable. According to Eqs. 9 and 10, the separation causes an increase in impedance between t1.bis and t1, causing a positive reflection and the first rising limb of the wave form (Fig. 7-2) (assuming the permittivity of the handle material is the same or lower than that of the insulation between the inner and outer conductors of the coaxial cable). Other features of the wave form can also be described by Eqs. 9 and 10. At the point where the rods exit the handle (t1 in Fig. 7-2) the permittivity increases (in moist soil) and impedance decreases, and a corresponding negative reflection occurs shown by the first descending limb in Fig. 7-2.

As the pulse travels along the rods it enters an environment of continuously decreasing complex impedance in moist soils due to the relatively low resistance of the soil to conduction of the signal voltage from one rod to

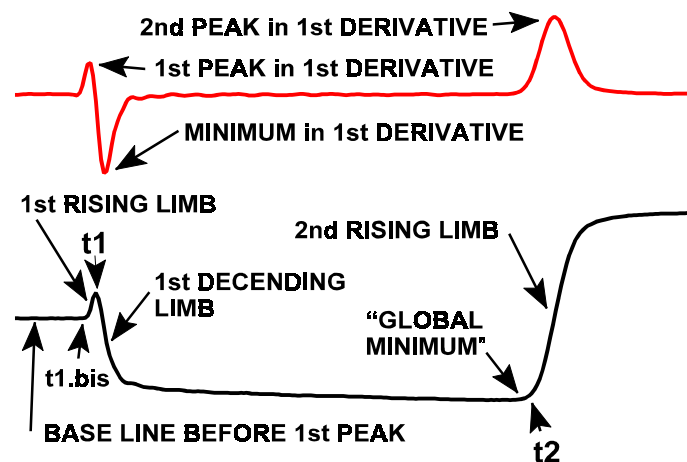

Figure 7-2. The TDR wave form (bottom) and its first derivative with respect to time(top), with features labeled.

the other. The total resistance decreases with probe length so the impedance decreases as well. This causes negative reflections at all points along the rods. Since the resistance is continuously (and usually smoothly) decreasing with rod length the reflections are not sudden as they are at the connection of the cable to the rods. Thus, the wave form shows a continuous decline as distance from the handle increases.

The distal ends of the rods represent an open circuit with corresponding high impedance since the wave guide ends. This causes a large positive reflection and a jump in the level of the wave form - the second rising limb (Fig. 7-2).

7.4 Visual Wave Form Interpretation and Early Computer Programs

Topp et al. (1982) described a method of interpreting wave forms captured on paper using a chart recorder or by photographing an oscilloscope screen. This analysis consisted of two graphical algorithms. Algorithm 1 consisted of drawing a horizontal line across the top of the first peak, and drawing a line tangent to the descending limb of the first peak (Fig. 7-2). The intersection of these lines defined t_1 . Algorithm 2 consisted of drawing a horizontal line tangent to the base line between the first peak and second inflection, and drawing a line tangent to the second inflection. The intersection of the latter two lines defined t_2 . The travel time of the pulse in the part of the wave guide that was buried in the soil was $t = t_2 - t_1$. Peaks and inflections were identified by eye and no computer code or algorithms were presented.

Later, Baker and Allmaras (1990) discussed a computer program for interpretation of wave forms following the ideas of Topp et al. (1982). The program, which was not published, included the following steps applied to a wave form consisting of 200 data points (Fig. 7-3):

- 1) Smooth and differentiate the data (Savitsky and Golay, 1964).
- 2) Use a loop to search the wave form data for the global minimum, V_{MIN} , and associated time, $t_{2.1}$.
- 3) Find the local maximum, V_{1MAX} , and associated time, t_{1p} , in the data between the first point and $t_{2.1}$. This is the time, t_{1p} , of the first peak.
- 4) Find the most negative derivative, D_{MIN} , the corresponding time, t_{DMIN} and wave form value, V_{tDMIN} , in a region of 25 points following t_{1p} . The slope of the first descending limb is D_{MIN} .
- 5) Define a line with intercept V_{1MAX} and slope of zero that is horizontal and tangent to the first peak. Define a second line with slope D_{MIN} and intercept such that it passes through V_{tDMIN} at t_{DMIN} . Solve the two lines for their intersection point and associated time, t_1 , that corresponds to the point where the rods exit the handle.
- 6) Find the maximum derivative, D_{2MAX} , in a region of 25 points following V_{MIN} , and associated time $t_{2.2}$ and wave form value $V_{t2.2}$.
- 7) Define a line tangent to the second inflection with slope D_{2MAX} and passing through $V_{t2.2}$ at $t_{2.2}$. Define a horizontal line tangent to V_{MIN} . Solve for the intersection of these lines to find t_2 , the time corresponding to the ends of the rods.

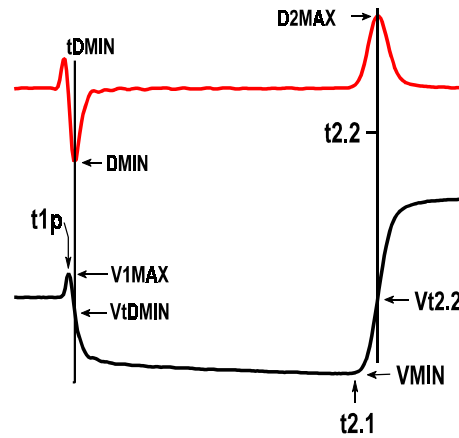

Figure 7-3. The TDR wave form (bottom) and its first derivative (top) with features identified by Baker and Allmaras (1990) (our nomenclature).

The travel time of the pulse through the exposed length of the rods was $t_1 = t_2 - t_1$. While these algorithms worked well for relatively moist soils there were problems with the absence of D_{MIN} and absence or movement of V_{MIN}

and associated times in wave forms for dry, low bulk density soils (see Section 7.5.1).

Heimovaara and Bouten (1990) described a computer program that involved fitting lines to the second inflection and to the base line between t_1 and t_2 . The regions of data points to which these lines were fit were determined empirically for a given probe. Also, they recognized that the wave form might not always descend at t_1 and so introduced the concept of fitting lines to the rising limb of the first inflection and to the base line before the first inflection, and using the intersection of these lines to define a time, $t_{1.bis}$, corresponding to the point of separation of the cable conductors. A correction time was added to $t_{1.bis}$ to get t_1 . This correction time was determined by performing a single measurement in air before probe installation.

The methods of Topp et al. (1982), Baker and Allmaras (1990), and Heimovaara and Bouten (1990) were found not to work for all Pullman clay loam soil conditions encountered at Bushland, Texas and in other soils in the early 1990s. Specific problems encountered and methods of dealing with them will be discussed in the following sections.

7.5 Factors Influencing Wave Form Shape

Many conditions may alter the wave form from the classical forms displayed in Figures 7-1, -2, and -3. It is perhaps an accident of location, climate, and soil type that many of the early computer algorithms emphasized finding the minimum, VMIN, and its time, $t_{2.1}$; the second maximum in the first derivative, D2MAX, and its time, $t_{2.2}$; and the minimum of the first derivative, DMIN, and its time, t_{DMIN} (see Fig. 7-3). In humid environments where soils are seldom dry, and are well leached so that bulk electrical conductivity is low, these features are found in almost all wave forms and can be reliably used as keys for computer analysis. However, in dry soils DMIN and the descending limb of the first peak may disappear. Also in dry soils, the position of VMIN may change dramatically, moving from the right side to the left side of the wave form. In soils with high bulk electrical conductivity the wave form may rise only slowly at the point corresponding to the ends of the rods; making the value of D2MAX so low as to be lost in the noise level of the first derivative. These and other factors influencing wave form shape are discussed here. Later, a suite of algorithms for interpreting wave forms despite these changes in shape will be presented.

7.5.1 Influence of Dry Soil on Wave Form Shape

As the soil dries, the first descending limb (Fig. 7-2) becomes less steep. Since dry soil has about the same permittivity as the plastic materials used in most probe handles there may be little or no impedance change between the wave guide in the handle and in the soil. Indeed, if the soil is both dry and of low bulk density the impedance of the wave guide may actually increase in the soil compared to the handle. Both conditions cause the first descending limb to be absent (Fig. 7-4) and render ineffective both algorithm 1 of Topp et al. (1982) and the corresponding methods of Baker and Allmaras (1990). Dry soils of low bulk density are usually found close to the surface. Since this is where the TDR method enjoys its greatest advantage compared to its nearest competitor, neutron scattering, it is imperative that the method be usable in such soils. For dry soil the second inflection, caused by the distal ends of the rods, is invariably steep and high, making it easy to find by searching for D2MAX. However, at the same time the global minimum may not occur after t_1 or the position of the local minimum may shift from just before the second inflection to a point just after the first peak, or to any intermediate position. This causes variations in the intersection of the two lines (horizontal tangent to global minimum and tangent to second inflection) that have no relation to the travel time, t_1 .

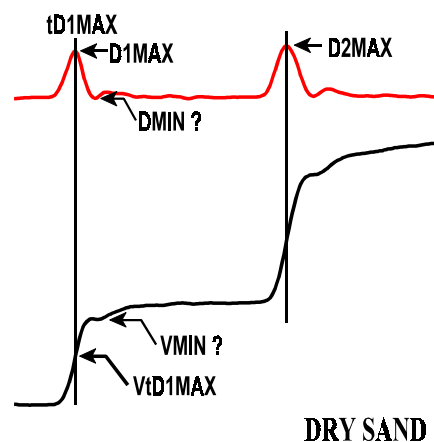

Figure 7-4. Influence of dry soil on wave form shape illustrating difficulty of finding DMIN and VMIN.

Another phenomenon sometimes found in low bulk density soils is the double peak. This may be due to compression of a thin layer of soil next to the handle as the probe was inserted into the soil at installation time. This higher bulk density soil will exhibit a lower impedance due to lower porosity (air has a permittivity of 1) and will cause the dip in the wave form after the handle. As the pulse enters less compressed soil it encounters a higher impedance and the reflected wave form rises, only to lower again as the pulse travels further down the rods (due to the impedance decline associated with the lowering of total resistance with rod length). It is important to have an algorithm to discriminate between these peaks.

7.5.2 Influence of Probe Design on Wave Form Shape

The height of the first peak increases with the separation distance of the rods because the impedance at this point in the wave guide increases with the separation distance (Eq. 10; Fig. 7-5). The impedance and peak height are inversely proportional to the diameter of the rods. The height is also influenced by the permittivity of the material separating the proximal ends of the probes (Eq. 9). For a handle made of epoxy (ϵ_a approx. 3), rod diameter of 3.2 mm and spacing of 30 mm the characteristic impedance increases from 50 ohms in the cable to approx. 90 ohms in the part of the stainless steel wave guide embedded in the handle (Fig. 7-5). The pulse travel time between $t_{1.bis}$ and t_1 increases with the permittivity of the material between the point of splitting the antenna cable and the connections to the rods. It also increases with the separation distance of the rods. Finally, this travel time increases with the distance between the split in the cable and the point of connection to the rods.

Consider an early type of TDR probe consisting of two stainless steel rods buried parallel to one another in the soil with the proximal ends connected to bifilar antenna cable. Connections were sometimes made using alligator clips, sometimes soldered, and sometimes made by clamping the wire to the rod with a screw. The perpendicular

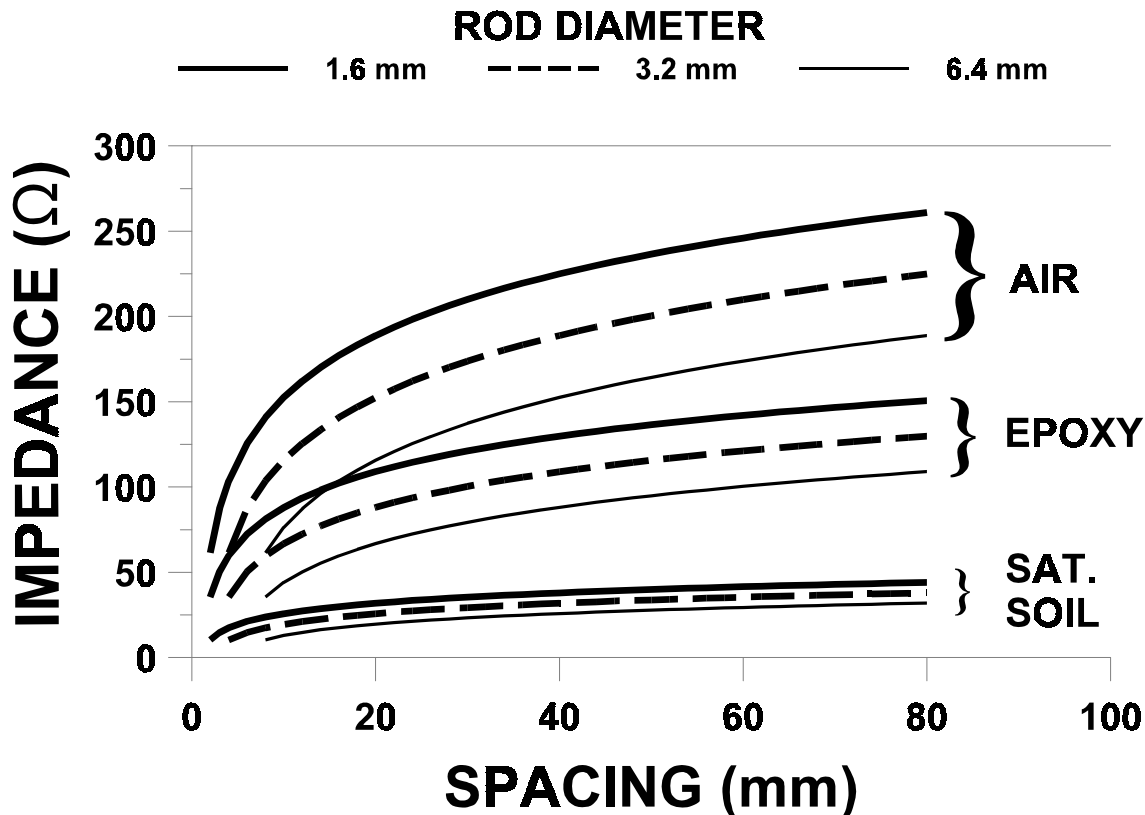

Figure 7-5. Influence of rod spacing, rod diameter, and permittivity of the medium on impedance of the waveguide according to Eqs. 9 and 10. Permittivities are: AIR, close to unity; EPOXY, close to 3; and SATurated SOIL, approx. 35.

distance between the rods was the separation distance. Typically the antenna cable would have a characteristic impedance of 300 ohms. In order to match impedances (thus lowering signal loss and distortion) between the antenna cable and the 50 ohm wave guide of the cable tester a balun (transformer) would usually be used to connect the antenna cable to the cable tester. In the case of our probe made with antenna cable and two rods, the connections are separated by the soil between the distal ends of the rods. In this case the height of the peak is influenced not only by the separation distance but by the water content of the intervening soil (assuming the probe is buried). For dry soil the impedance may be nearly the same as for epoxy but for wet soil the value of ϵ_a may approach 35 and the impedance may be 30 ohms or lower (Fig. 7-5).

Using our probe made with antenna cable and two rods we can see several reasons why the height of the first peak and the time between $t_{1.bis}$ and t_1 might not be reproducible between probes in the field. The length of cable split may vary, the separation distance at the proximal rod ends may vary (over time even if controlled at installation), and the permittivity of the porous medium separating the two wires of the wave guide may vary in time and space between the cable split and the point of connection to the rods. If the rods are installed vertically and the point of connection is at the soil surface the split cable may be separated by air, whereas if the probe is installed deeper in the soil the split cable will be separated (along at least some of its length) by soil that varies in permittivity as it wets and dries.

If we have a reliable algorithm for finding t_1 we need not worry about the time between $t_{1.bis}$ and t_1 . However, as we have seen, there are soil conditions that make finding t_1 alone practically impossible. Also, the varying permittivity of the material separating the rods makes the height of the first peak variable (the first rising limb may cease to exist under some conditions), further complicating the search for t_1 . If t_1 is difficult to find we may search for an algorithm that finds $t_{1.bis}$ reliably. But, since the travel time we ultimately need is $t_t = t_2 - t_1$ not $t_2 - t_{1.bis}$, we would need to have a consistent time ($t_1 - t_{1.bis}$) in order to use $t_{1.bis}$ to find t_t . With our probe made of antenna cable and two rods it is virtually impossible to guarantee consistent conditions that would allow reliable determination of either t_1 or $t_{1.bis}$, or that would guarantee that $t_1 = t_{1.bis} + t_c$ where t_c is a constant.

For these reasons the TDR probes commercially available today are invariably made with the split in the cable (usually coaxial cable) and the connections to the rods fixed in some sort of rigid configuration, usually called the handle; and enclosed in a material of consistent and constant permittivity. The handle may be made of epoxy resin, delrin, polymethyl methacrylate (acrylic), RTV silicone or some other plastic and may contain metal for shielding or connection of rods. These handles share the properties of a fixed separation distance, fixed permittivity of the material separating the conductors of the wave guide in the handle (with some minor temperature variations), fixed distance between the cable split and the point of connection to the rods, and fixed distance between the point of connection at the proximal ends of the rods and the point at which the rods exit the handle and enter the soil. Such handles provide optimal conditions for reliable algorithms determining $t_{1.bis}$ and t_1 , and the rest of this discussion will assume such a handle.

It has been argued (Spaans and Baker, 1993), that in order to match impedances (thus lowering signal loss and distortion) between the coaxial cable and the two rods in a bifilar probe, a balun should be used at the point of connection. Also, the balun should serve to convert the unbalanced signal in the coaxial cable (where the inner conductor carries the wave form and the outer conductor remains at virtual ground) to a balanced signal in the two rods (where both conductors carry the wave form). The argument states that, absent a balun, the unbalanced signal will tend to balance as it travels down the rods, eventually becoming closely balanced at some point along the rods. But, between the handle and that point the signal reflections will be distorted due to the partial imbalance. If the rods are very short the distorted part of the wave form may interfere with the second inflection. The trifilar probe responds to this concern by providing a waveguide that is geometrically more similar to a coaxial waveguide (Zegelin et al., 1989). Measurements by Zegelin et al. (1989) show only minor differences in wave form shape between trifilar and coaxial waveguides.

7.5.3 Influence of Bulk Electrical Conductivity on Wave Form Shape

As the bulk electrical conductivity (BEC) of the soil increases the impedance of the wave guide in the soil decreases due to the lowering of the resistance component of impedance. In addition there is a lowering of signal voltage along the length of the rods due to conduction through the soil. This causes the wave form level after the first peak to decline relative to that for a soil of lower BEC. It also lowers the slope, $D2MAX$, of the second rising limb (Hook and Livingston, 1995) and the final height to which the wave form rises after the second inflection. This

latter fact has been used successfully to find the BEC of soils (e.g. Dalton et al., 1984; Topp et al., 1988; Wraith, 1993).

However, these effects can make it difficult to reliably find the second rising limb by searching for D2MAX. Smoothing of the wave form and its first derivative can make the determination of D2MAX more reliable by reducing the relative height of peaks in the first derivative that are caused by random noise in the wave form. However, in case of a very weak second rising limb the peak in the first derivative can be so spread out that the apparent position of the second rising limb, deduced from the position of D2MAX, is not consistent. Fortunately, in these cases the high BEC guarantees that the wave form will slope downward between t_1 and t_2 , in turn guaranteeing that the position of VMIN is always just before the second rising limb. Thus, in this situation, VMIN can be used reliably as the key to an algorithm used to find t_2 described below.

Unfortunately, increased soil salinity is only one source of increase in BEC. Another source of BEC is the conductivity arising from certain clays, especially clays with high CEC. These are often expanding lattice clays containing cations entrapped between clay layers. When such soils are dry they exhibit low BEC, probably due to the contracted nature of the clay micelles and discontinuous water films on soil particles and the resulting low mobility of cations. As these soils wet their BEC increases as shown in Fig. 7-6 for an expansive Pullman clay loam with mixed mineralogy at Bushland, TX. The effects are apparent as a lowering of the second inflection and final wave form height as these soils wet. Although the problems posed by this phenomenon vis-a-vis the finding of t_2 can usually be solved, the implications for relating TDR wave forms to soil salinity cannot be ignored.

Furthermore, this phenomenon has implications for the application of frequency domain (FD) probes to water content determination in these soils, similar to the implications and reported problems related to salinity effects on water content determination by FD probes. A frequency domain probe relies upon the change in frequency of an oscillator circuit caused by the change in permittivity of the soil around the probe. For the oscillator to change states the reflected voltage must reach the set point voltage of the oscillator at which time the oscillator changes states and drives the wave guide to the opposite polarity. The time it takes for the reflected voltage to reach the set point is determined not only by the travel time to t_2 but by the additional time between t_2 and the time at which the second rising limb rises to the set point. Thus, the frequency of oscillation is dependent not only on t_2 or t_2-t_1 but on the BEC of the medium. Since the BEC may be changed by salinity changes, clay content changes and/or water content changes in a clayey or saline soil it is obvious that calibration of an FD probe for routine field use, where these factors may change in time and space, is problematic. Not all clay soils show increases in BEC with water content as illustrated in Fig. 7-7 for a Cecil clay of kaolinitic mineralogy from Watkinsville, GA.

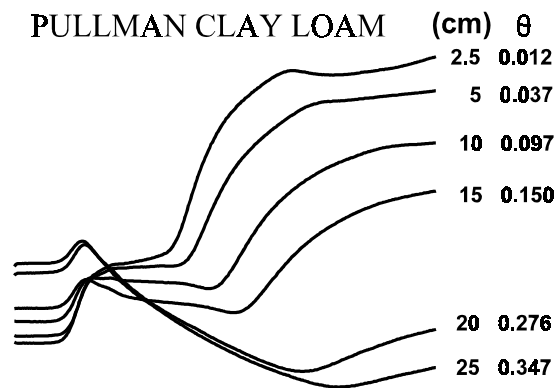

Figure 7-6. Effect of soil water content (θ , $m^3 m^{-3}$) on the bulk electrical conductivity of a non-saline clay loam at several depths (cm) in the A horizon (2.5 to 15 cm) and B horizon (20 and 25 cm).

7.5.4 Influence of Equipment and Acquisition Method on Wave Form Shape

There are myriad ways to generate the TDR pulse and capture the reflected wave form. Some of the first systems used a separate pulse generator and oscilloscope and captured the wave form by photographing the oscilloscope screen. The Tektronix 1502, 1502B and 1502C TDR cable testers have also been used very widely and successfully. This discussion is limited to Tektronix cable testers although some of the discussion will apply to other instruments. The model 1502 is an analog output device that outputs a voltage level to drive the pen on a chart recorder when a toggle switch is pushed. The X-output is a ramping voltage to drive the x-axis movement of the pen at a constant speed across the paper. The Y-output is a voltage varying with the level of the wave form at an ordinate on the wave form corresponding to the level of the ramping X-output. The instrument takes 20 s to output a signal in

this fashion. Baker and Allmaras (1990), Herkelrath et al. (1991), Evett (1993, 1994) and others described systems for capturing the Y-output signal unattended and in electronic digital form by using a data logger or computer to toggle the output via a relay and digitizing the Y-output voltage, storing the set of values in memory. The digital models 1502B and 1502C simplified the process of wave form capture by digitizing the wave form internally and providing a digital connection to a computer (usually via RS-232 serial port).

There are trade offs between the digital and analog cable testers. The pulse of the analog model 1502 has a 120 ps rise time, somewhat faster than the 150 ps rise time for the digital models. The Y-output of the 1502 can be digitized to almost any precision desired and many points across the wave form can be captured. For instance it is relatively easy to digitize to 12 bits resolution and capture 400 points per wave form using inexpensive equipment. The number of points captured has some implications for the reliability of computer algorithms. The digital cable tester provides 251 points across the wave form and is not adjustable in this respect. In some situations the first peak in the wave form may be so very sharp that it is less than one point wide. In such a case the peak may not appear on every wave form. Toggling the 1502 to output a wave form and digitizing the Y-output is prone to some errors in that the timing of wave form output and data acquisition may be difficult to synchronize. This can result in digital wave form data that are good in the middle but have sharp drops or rises at the ends that are artifacts of the data acquisition process, and not related to the wave guide and soil. A computer program must discriminate against these artifacts.

With any form of digitization there is the certainty of some noise in the digitized wave form plus the possibility of noise in the signal arising from outside sources. Smoothing of the wave form can reduce the influence of noise on the effectiveness of algorithms for finding t_1 and t_2 by making clearer the times t_{D1MAX} and $t_{2.2}$ of the peaks in the first derivative. But excessive smoothing can result in errors due to loss of peaks in either the wave form or its first derivative. Also, excessive smoothing can change the slopes of the rising and descending limbs of the wave form to which tangent lines are fit. This in turn can change the point of intersection of tangent lines and the value of t_1 or t_2 derived from these intersections. The models 1502B and 1502C offer smoothing of the wave form by averaging of successive captured wave forms. While effective this may take more time than computer algorithms for smoothing such as those employed by Baker and Allmaras (1990).

7.5.5 Influence of Cable Length on Wave Form Shape

As the pulse moves down the cable to the probe its higher frequency components are selectively attenuated. The cable acts as a low pass filter. This means that the longer the cable, the slower the rise time of the pulse at the probe, and the less steep the rising and descending limbs of the inflections caused by probe handle and end of rods, i.e. transition time increases (Hook et al., 1992; Hook and Livingston, 1995). If the wave form is correctly interpreted then the travel time, t_r , should be constant despite cable length. However, if the probe is short enough, the descending limb of the first peak will intersect the rising limb of the second inflection causing the travel time to be incorrect. The longer the cable, the lower the slope of the descending limb and the longer the probe must be to avoid this problem. However, longer probes cause increased attenuation of the step pulse due to DC conduction through the soil between the rods and due to the lossy nature of soils. In some soils the increased attenuation causes the reflection of the step pulse at time t_2 to be lost. Since the slope of the descending limb also decreases with increasing BEC of the soil, a probe length appropriate for a given cable length is difficult to predict. Another problem associated with long cable lengths is the loss of the first peak altogether.

7.6 Algorithms for Graphical Interpretation of Wave Forms

The preceding discussion shows that computer based interpretation of TDR wave forms requires algorithms that include decision making ability, encapsulating as far as possible the human ability to recognize the inflections of the wave form reliably despite severe changes in shape; as well as the human ability to disregard noise. Such algorithms are described below in the order in which they are employed in the TACQ.EXE program.

7.6.1 Positioning of the Wave Form on the Screen

We are aware of no reports that describe a method for positioning the wave form on the cable tester screen that allows for reproducible and consistent computerized finding of t_t . Yet positioning has a direct affect on whether enough data are present to reliably fit lines to various portions of the wave form. Consider a wave form similar to that in Figs. 7-1 to 7-3 but occupying only a portion of the screen. Since the data are digital representations of an analog phenomenon there are only a fixed number of data pairs of voltage and time representing a screen of data. For instance for the Tektronix model 1502B/C cable testers there are 251 data pairs. For Fig. 7-2 there were only 4 data pairs in the first rising limb, 12 data pairs in the first descending limb, and about 25 data pairs in the second rising limb. For Fig. 7-4 there were 18 data pairs in the first rising limb, only 3 data pairs in the first descending limb, and 24 data pairs in the second rising limb. If the wave forms were compressed horizontally even by 50% it would be difficult to find enough data points to fit tangent lines to key parts of the wave forms. Thus it is best to have the wave form occupy as much of the screen as possible. This is easily accomplished using the distance per division, DIST/DIV, and relative velocity of propogation, V_{pr} , settings of the cable tester. However, the width of the wave form increases with soil water content, and unless the cable tester is set when the water content is at saturation the wave form may widen enough with increasing water content that the second rising limb can no longer be seen on the screen. Figure 7-6 illustrates this. If the wave form width had been set to occupy the full screen for dry soil (2.5 cm depth, $\theta = 0.012$), the wave form for wet soil (25 cm, $\theta = 0.347$) would be too wide for the second rising limb to appear on the screen.

Fortunately, if we have a good idea of what the saturated water content would be for a given soil, we can compute the desired screen width in ns as follows. First compute the apparent permittivity from Eq. 16 (Topp et al., 1980):

$$\epsilon_a = 3.03 + 9.3\theta_s + 146\theta_s^2 - 76.7\theta_s^3 \quad [16]$$

where θ_s is the saturated water content. The saturated water content can be estimated from the soil dry bulk density, ρ_b . Simply calculate the total soil porosity, $f = 1 - \rho_b/\rho_p$, where ρ_p is the particle density (assumed equal to 2.65); and assume that all air is displaced when the soil is saturated so that $\theta_s = f$. Calculate the velocity of propogation using Eq. 2. Then calculate the travel time over the length of the probe by inverting Eq. 4. Adding additional time for the base line before the first peak and for the second rising limb after t_2 we have the time that we wish to have represented by the full screen width. Then we have only to find a combination of distance per division (DIST/DIV) and relative propagation velocity (V_{pr}) settings that results in a full scale horizontal axis at least equal to this time. Experience shows that it is best to have at least one tenth of the screen width (one division) between the left had side of the screen and the first peak in order to reliably fit the base line. Also it is best to have at least 0.2 of the screen width between t_2 and the right hand side of the screen to reliably fit the tangent to the second rising limb. A computer algorithm for finding appropriate combinations of DIST/DIV and V_{pr} , given the soil's saturated water content and the probe length, is given in Appendix 7-A. Example results for several probe lengths and saturated water contents are given in Table 7-1. These are for the Tektronix 1502B or 1502C cable testers which allow variation of V_p settings in hundreths.

Table 7-1. Optimum relative propagation velocity (V_{pr}) and distance per division (Dist/Div) settings and resulting screen widths in ns for several combinations of probe length and saturated water content. Settings give screen widths within 2% of those calculated using the assumptions in the preceding paragraph.

| Probe Length (m) | $\theta_s = 0.5$ | | | $\theta_s = 0.4$ | | | $\theta_s = 0.3$ | | |
|------------------|------------------|--------------|-------------------|------------------|--------------|-------------------|------------------|--------------|-------------------|
| | V_{pr} | Dist/Div (m) | screen width (ns) | V_{pr} | Dist/Div (m) | screen width (ns) | V_{pr} | Dist/Div (m) | screen width (ns) |
| 0.05 | 0.59 | 0.025 | 1.40 | 0.69 | 0.025 | 1.20 | 0.85 | 0.025 | 0.98 |
| 0.10 | 0.59 | 0.05 | 2.80 | 0.69 | 0.05 | 2.39 | 0.42 | 0.025 | 1.96 |
| 0.15 | 0.39 | 0.05 | 4.20 | 0.46 | 0.05 | 3.59 | 0.56 | 0.05 | 2.94 |
| 0.20 | 0.59 | 0.10 | 5.61 | 0.69 | 0.10 | 4.78 | 0.42 | 0.05 | 3.92 |
| 0.30 | 0.39 | 0.10 | 8.41 | 0.46 | 0.10 | 7.18 | 0.56 | 0.10 | 5.87 |

For the older Tektronix model 1502 cable tester, the V_{pr} setting has much less flexibility. There are three buttons for V_{pr} . Pressing Solid PTFE gives a V_{pr} of 0.70; pressing Solid POLY gives a V_{pr} of 0.66; and pressing OTHER allows the V_{pr} to be adjusted from 0.55 to 0.99 by turning the VAR screw. When all three buttons are out the V_{pr} is 0.99; or, when the VAR button is pressed in and the VAR screw is turned all the way clockwise, the V_{pr} is 0.99. Unfortunately, there is no simple way to know the exact V_{pr} value that is set with the VAR screw, so the user is left with just three usable V_{pr} settings, 0.66, 0.70, and 0.99. If the Tektronix 1502 is selected in Software Setup in TACQ then pressing D for defaults will, in addition to allowing the user to set the V_{pr} and Dist/Div settings, give two recommendations for Dist/Div (using the V_{pr} value chosen by the user). The first recommendation will show a negative percent error, and the second will show a positive percent error. These are the percentages difference from the optimum screen width in ns. If the negative percent error is small, then the user may be able to use the corresponding Dist/Div recommendation. Otherwise, the user should use the Dist/Div recommendation that gives a positive percent error. This will result in a screen width in ns that is wider than absolutely necessary, but that will ensure that the second rising limb of the wave form is not lost off the right side of the screen when the soil becomes saturated. The user should use V_{pr} values of 0.66, 0.70, and 0.99 and see which gives the smallest percent error. Tables 7-2 and 7-3 give some possible combinations of probe length and Dist/Div and associated errors as a percentage of the optimum screen width in ns for V_{pr} values of 0.99 and 0.70, respectively.

Table 7-2. Distance per division (Dist/Div) settings, and associated errors compared with optimum screen width, for V_{pr} of 0.99 and for a range of saturated water contents and probe lengths. For a cable tester set for units of feet.

| Probe Length (m) | $\theta_s = 0.5$ | | $\theta_s = 0.4$ | | $\theta_s = 0.3$ | |
|------------------|------------------|---------------|------------------|---------------|------------------|---------------|
| | Dist/Div (ft) | Percent Error | Dist/Div (ft) | Percent Error | Dist/Div (ft) | Percent Error |
| 0.05 | 0.1 | -27 | 0.1 | -14 | --- | --- |
| | 0.2 | 47 | 0.2 | 72 | 0.1 | 5 |
| 0.10 | 0.2 | -27 | 0.2 | -14 | 0.1 | -48 |
| | 0.5 | 83 | 0.5 | 115 | 0.2 | 5 |
| 0.15 | 0.2 | -51 | 0.2 | -43 | 0.2 | -30 |
| | 0.5 | 22 | 0.5 | 43 | 0.5 | 75 |
| 0.20 | 0.5 | -8 | 0.2 | -57 | 0.2 | -48 |
| | 1.0 | 83 | 0.5 | 7 | 0.5 | 31 |
| 0.30 | 0.5 | -39 | 0.5 | -28 | 0.5 | -13 |
| | 1.0 | 22 | 1.0 | 43 | 1.0 | 75 |

It is obvious that for some combinations of probe length and saturated water content there is no combination of Dist/Div, and the V_p settings possible with the push buttons on the Tektronix 1502 cable tester, that comes close to providing an optimum screen width. This doesn't necessarily mean that good data can't be obtained, but it does mean that the user may want to chose probe lengths that lend themselves more easily to optimization of this sort.

Table 7-3. Distance per division (Dist/Div) settings, and associated errors compared with optimum screen width, for V_{pr} of 0.70 and for a range of saturated water contents and probe lengths. For a cable tester set for units of feet.

| Probe Length (m) | $\theta_s = 0.5$ | | $\theta_s = 0.4$ | | $\theta_s = 0.3$ | |
|------------------|------------------|---------------|------------------|---------------|------------------|---------------|
| | Dist/Div (ft) | Percent Error | Dist/Div (ft) | Percent Error | Dist/Div (ft) | Percent Error |
| 0.05 | --- | --- | --- | --- | --- | --- |
| | 0.1 | 4 | 0.1 | 21 | 0.1 | 48 |
| 0.10 | 0.1 | -48 | 0.1 | -39 | 0.1 | -26 |
| | 0.2 | 4 | 0.2 | 21 | 0.2 | 48 |
| 0.15 | 0.2 | -31 | 0.2 | -19 | 0.2 | -1 |
| | 0.5 | 73 | 0.5 | 102 | 0.5 | 147 |
| 0.20 | 0.2 | -48 | 0.2 | -39 | 0.2 | -26 |
| | 0.5 | 30 | 0.5 | 52 | 0.5 | 85 |
| 0.30 | 0.5 | -14 | 0.2 | -60 | 0.2 | -51 |
| | 1.0 | 73 | 0.5 | 1 | 0.5 | 24 |

7.6.2 Wave Form Smoothing

Wave forms are smoothed using the Savitsky-Golay procedure (Gorry, 1990). The user may choose any degree of smoothing from none to a 21 point smooth. Only odd numbers of points are allowed to provide a symmetrical smooth. Derivative smoothing may vary from none to a 19 point smooth. Derivative smoothing must be over a number of points at least two lower than the number chosen for wave form smoothing. The user should specify only enough smoothing to reduce extraneous peaks in the first derivative. Excessive smoothing can cause errors, most particularly loss of sharp wave form features such as the first peak.

7.6.3 Circumscribing Wave Form Interpretation

In order to avoid dealing with sudden drops or rises in level that may occur at the beginning or end of the wave form (usually only seen with the 1502 cable tester) the user may set any number of points not to be used in wave form interpretation at either end of the wave form. Vertical lines on the screen show the parts of the wave form thus excluded. The number of points for either end may be set by entering a number or by moving the lines interactively using the cursor keys. Also, the user may define a limit excluding data in the right hand side of the wave form from being used to find the first peaks in the wave form and first derivative. This excludes the second peak in the first derivative from consideration for finding time 1 and eliminates confusion between the first and second rising limbs. Correspondingly, the user may exclude a portion of the left hand side of the wave form from consideration when determining the location of the second rising limb. Again, these limits may be set by entering a number or by using the cursor keys to move the vertical lines that represent the limits on the computer screen.

User Set Limits on Data Searched for Wave Form Features:

| | |
|------------------|----------------------------------------------------------------------------------------------------|
| StartPt | Time before which to exclude data from examination. |
| EndPt | Time after which to exclude data from examination. |
| D2Lim | Time at which to begin search for second maximum in the first derivative. Search ends at EndPt. |
| D1Lim | The data between StartPt and D1Lim are searched for the first peak in the first derivative, D1MAX. |
| SafetyLim | If t1 is less than this time then zeros are written to the output. |
| t1Swath | Number of data points after tD1MAX to use when searching for V1MAX. |

7.6.4 Choosing Wave Form Interpretation Methods:

For finding the center of the second rising limb (t2.2) the user may choose to use only a global minimum method (i.e. find VMIN and t2.1), only a method that finds D2MAX and associated time t2.2, or an automatic method that uses the global minimum method if the value of D2MAX is below a user set threshold, D2Thresh, and that uses the time of D2MAX otherwise. The global minimum method for t2 is similar to that of Baker and Allmaras (1990) except that the search for VMIN is conducted in the data between t1p and EndPt rather than over all the data. Regardless of the method for finding t2.2 the line tangent to the second rising limb is found by linear regression on a swath of points around t2.2 (user chosen swath width).

The user may choose how to fit the "horizontal" intersecting line that partially defines t2. The line is either a horizontal line passing through the wave form at t2.1 or a line fit by regression to a swath of points just prior to t2.1 (user chosen swath width). If the horizontal tangent method is chosen the program will examine the slope of a fitted line and if the slope is positive the program will use the fitted line rather than the horizontal tangent. This avoids improper interpretation of wave forms from dry soils for which VMIN may be located closer to t1 than t2.

For finding t1 the user may choose to use a method (M1), similar to that of Baker and Allmaras, that finds t1p by searching for V1MAX and DMIN but that starts the search from the time of D1MAX; and that, failing to find V1MAX and D1MAX assigns values as explained below. Or, the user can choose method M2 that finds D1MAX and fits a line tangent to the first rising limb and a horizontal line tangent to the baseline before the first rising limb and solves the intersection for t1.bis. Method M2 then adds a user set time, t_c, to t1.bis to get t1. The time t_c = t1 - t1.bis is found by measurements on probes installed in wet soil using method M1.

7.6.5 Finding Travel Times

Times t_1 and t_2 are reliably found by a combination of searches and decisions based on the results of those searches. In this discussion the wave form is assumed to consist of NP digitized data pairs of voltage and time with equal increments of time between consecutive data pairs.

1. Smooth data and first derivative using the Savitsky-Golay method and user set number of points, and find the maximum and minimum first derivative, maxDeriv and minDeriv.
2. Scan the wave form data from D2Lim to EndPt to find the lowest value, VMIN, and corresponding time, t2.1.
3. Scan the first derivative in a loop from StartPt to D1Lim to find the first maximum value, D1MAX, and associated time tD1MAX. If tD1MAX is greater than t2.1 then reduce D1Lim by NP/40 and try again. If D1Lim reaches 0 then write zeros to output.
4. Scan wave form data from tD1MAX+30 to EndPt for the lowest value, VMIN, and associated time, t2.1.
5. Scan wave form data from tD1MAX to tD1MAX + NP/8 to find the highest value, V1MAX, and associated time, t1p. Update V1MAX whenever the wave form value is higher than V1MAX and accumulate a count whenever the wave form value is lower. If count is greater than t1Swath then stop the search. This avoids finding the second peak if double peaks exist. If the wave form is continuously rising then t1p may be greater than tD1MAX + NP/20. If so then set t1p equal to tD1MAX + NP/20 and set V1MAX to the wave form value at that time.
6. Unless the global minimum method for finding t2 is forced, scan the derivative data from D2Lim to EndPt for the maximum derivative, D2MAX, and corresponding time, t2.2.
7. If the t2 derivative peak method is forced or if the t2 method is automatic and D2MAX is larger than D2Thresh then scan the data from t2.2 to t2.1 to find the zero derivative nearest to t2.2. Redefine t2.1 at this point and take the value of the wave form at this point as VMIN. If no zero derivative is found in this range of data then set t2.1 equal to t1p plus tAtVMINfrac times the quantity (t2.2 - t1p) and set VMIN equal to the corresponding value of the wave form.
8. If the method for t2 is automatic and D2MAX is less than D2Thresh then set t2.2 equal to t2.1 plus the offset (RiseLimbOffset) specified by the user and set D2MAX equal to the corresponding value of the first derivative. Then set t2.1 equal to t1p plus tAtVMINfrac times the quantity (t2.2 - t1p) and set VMIN equal to the corresponding value of the wave form.
9. If the local minimum method for t2 is forced then set t2.2 to t2.1 plus RiseLimbOffset (limited to less than or equal to NP) and set D2MAX to the corresponding value of the first derivative.
10. Regardless of how t2.2 is determined set Vt2.2 equal to the wave form value at t2.2.
11. Fit by linear regression a line to the base line between t2.1 and t2.1-BaseSwathWidth where BaseSwathWidth is a user chosen number of data points. If the slope of this line is positive then force a regression fit to the base line rather than a horizontal line tangent to VMIN.
12. Scan the derivative data from t1p to t1p plus t1Swath to find the lowest derivative value, DMIN, and corresponding time, tDMIN, which are associated with the descending limb of the first peak.
13. If DMIN is greater than -0.01 then set $DMIN=(y_{ll}-y_{uu})/(x_{uu}-x_{ll})$, and set tDMIN equal to t1p + 1. The

values of y_{ll} and y_{uu} are the minimum and maximum of the wave form, respectively, and the values of x_{ll} and x_{uu} are the minimum and maximum of the x-axis. Thus, the slope is scaled to the wave form amplitude.

14. Set V_{tDMIN} equal to the wave form value at t_{DMIN} , and if this value is greater than V_{1MAX} then set V_{tDMIN} to V_{1MAX} .
15. Calculate the time of the intersection of tangent lines for t_1 and if this time is less than t_{1p} then increase the value of t_{DMIN} and the magnitude of the slope, $DMIN$, until the intersection is at t_{1p} or greater.
16. If t_1 is less than the safety limit, $SafetyLim$, then write zeros to the file.
17. Set up limits on data used to fit tangent line to second rising limb as $t_{2.2-Xinc}$ and $t_{2.2+Xinc}$ where $Xinc$ is user chosen. If these limits are out of range then write zeros to file.
19. If actual point to point slope near t_{D1MAX} is greater than smoothed slope, $D1MAX$, then set $D1MAX$ to actual maximum slope.
20. Examine derivative before first rising limb for slope close to zero (slope lesser in magnitude than $[\maxDeriv-\minDeriv]/100$). If such points are found then use the average wave form value for those points as the intercept for a line tangent to the baseline with slope of zero. If such points are not found then set the intercept of the horizontal line to the minimum wave form value to the left of t_{D1MAX} .

7.7 References

- Baker, J.M., and R.R. Allmaras. 1990. System for automating and multiplexing soil moisture measurement by time-domain reflectometry. *Soil. Sci. Soc. Am. J.* 54(1):1-6.
- Dalton, F.N., W.N. Herkelrath, D.S. Rawlins, and J.D. Rhoades. 1984. Time-domain reflectometry: simultaneous measurement of soil water content and electrical conductivity with a single probe. *Science* 224: 989-990.
- Evet, S.R. 1994. TDR-Temperature arrays for analysis of field soil thermal properties. *In Proceedings of the Symposium on Time Domain Reflectometry in Environmental, Infrastructure and Mining Applications*, Sept. 7-9, 1994. Northwestern University, Evanston, Illinois.
- Evet, S.R. 1993. Evapotranspiration by soil water balance using TDR and neutron scattering. *In Management of Irrigation and Drainage Systems*, Irrigation and Drainage Div./ASCE, July 21-23, 1993, Park City, Utah. pp. 914-921.
- Gorry, P.A. 1990. General least-squares smoothing and differentiation by the convolution (Savitsky-Golay) method. *Anal. Chem.* 62:570-573.
- Heimovaara, T.J., and W. Bouten. 1990. A computer-controlled 36-channel time domain reflectometry system for monitoring soil water contents. *Water Resour. Res.* 26(10):2311-2316.
- Herkelrath, W.N., S.P. Hamburg, and F. Murphy. 1991. Automatic, real-time monitoring of soil moisture in a remote field area with time domain reflectometry. *Water Resour. Res.* 27(5):857-864.
- Hook, W.R., N.J. Livingston, Z.J. Sun, and P.B. Hook. 1992. Remote diode shorting improves measurement of soil water by time domain reflectometry. *Soil Sci. Soc. Am. J.* 56:1384-1391.
- Hook, W.R., and N.J. Livingston. 1995. Propagation velocity errors in time domain reflectometry measurements of soil water. *Soil Sci. Soc. Am. J.* 59:92-96.
- Savitsky, A., and M.J.E. Golay. 1964. Smoothing and differentiation of data by simplified least squares. *Anal. Chem.* 36:1627-1639.
- Spaans, E.J.A., and J.M. Baker. 1993. Simple baluns in parallel probes for time domain reflectometry. *Soil Sci. Soc. Am. J.* 57:668-673.
- Topp, G.C., J.L. Davis, and A.P. Annan. 1980. Electromagnetic determination of soil water content: Measurements in coaxial transmission lines. *Water Resour. Res.* 16(3):574-582.
- Topp, G.C., J.L. Davis, and A.P. Annan. 1982. Electromagnetic determination of soil water content using TDR: I. applications to wetting fronts and steep gradients. *Soil Sci. Soc. Am. J.* 46:672-678.
- Topp, G.C., M. Yanuka, W.D. Zebchuk, and S. Zegelin. 1988. Determination of electrical conductivity using time domain reflectometry: Soil and water experiments in coaxial lines. *Water Resour. Res.* 24:945-952.
- Williams, T. 1991. *The Circuit Designer's Companion*. Butterworth-Heinemann, Ltd., Pub. 302 pp.
- Wraith, J.M., S.D. Comfort, B.L. Woodbury, and W.P. Inskeep. 1993. A simplified waveform analysis approach for monitoring solute transport using time-domain reflectometry. *Soil Sci. Soc. Am. J.* 57:637-642.
- Zegelin, S.J., I. White, and D.R. Jenkins. 1989. Improved field probes for soil water content and electrical conductivity measurement using time domain reflectometry. *Water Resour. Res.* 25(11):2367-2376.

Appendix 7-A.

```
SUB BestDistDv.Vp (ProbeLen, FtMtrs, Theta)
'Routine for choosing the best combination of Dist/Div and Vp for a given
'probe length based on inversion of Topp's equation for permittivity, Ka,
'as a function of water content.  Written in Microsoft BASIC 7.1 by Steven R.
Evelt

'ProbeLen is probe length in meters.
'FtMtrs 'If 1 then units are feet else units are m.
'Theta is volumetric water content (m^3/m^3).

SHARED Vp
SHARED Dist
SHARED DistDv
SHARED CardType%

i% = 10
DIM TimeErr(i%)
DIM DistVal(i%)

'Limit values of water content:
IF Theta < 0 THEN Theta = 0
IF Theta > .6 THEN Theta = .6

'Calculate the apparent permittivity (Ka) (Topp et al., 1980):
Ka = 3.03 + 9.3 * Theta + 146! * Theta * Theta - 76.7 * Theta * Theta * Theta

'The velocity of propogation is a function of Ka:
v = .299792 * 1E+09 / SQR(Ka)

'The travel time is a function of v and probe length:
tt = ProbeLen / v

'Assume that the travel time should occupy 70% of the screen max.
NewTtFull = (tt / .7) * 1E+09 'in ns

row% = CSRLIN
col% = POS(0)

TryAgain% = 0
SELECT CASE CardType%
CASE 5
Start.Search:
'Try smallest Dist first, then next biggest, etc.
'Get Dist for i=1 to 10:
FOR i% = 0 TO 10
  DistDv = i%
  ReturnDistDv 'This returns one of the 11 possible Dist/Div settings.
  'Make sure DistM is in meters:  DistM is the distance per division.
  IF FtMtrs = 1 THEN
    'was in feet, convert to meters
    DistM = Dist * .3048
  ELSE
    'was in meters
    DistM = Dist
  END IF
  'Try biggest Vp first, then go to smallest
  FOR Vp = .99 TO .39 STEP -.01
    TtFull = DistM * 10 / (Vp * .2997925)
    IF TtFull >= NewTtFull THEN EXIT FOR
  NEXT Vp
```

```

        IF TtFull >= NewTtFull THEN EXIT FOR
NEXT i%
TimeError = (TtFull - NewTtFull) / NewTtFull
BestDist = Dist
IF ABS(TimeError) > .02 THEN
    PRINT "Best DIST/DIV and Vp not found."
    PRINT "Error was"; TimeError * 100; "%"
    PressAKey (5) 'Wait for a key press before continuing.
END IF
'One combination of Vp and Dist/Div is known.
'The Dist/Div value is in BestDist. Print both Vp and Dist/Div:
PRINT "          For VWC ="; Theta;
LOCATE row% + 1, col%
PRINT USING "recommend Vp: .## "; Vp;
PRINT "and DIST/DIV:"; BestDist;
IF FtMtrs = 1 THEN
    PRINT "ft";
ELSE
    PRINT "m";
END IF

CASE ELSE
'For Tektronix 1502 cable tester, not 1502B/C.
'Provide two closest Dist/Div values for given Vp.
Start.Search2:
'Get Dist for i=1 to 10:
FOR i% = 0 TO 10
    DistDv = i%
    ReturnDistDv
    'Make sure DistM is in meters:
    IF FtMtrs = 1 THEN
        'feet
        DistM = Dist * .3048
    ELSE
        'meters
        DistM = Dist
    END IF
    'Use actual Vp first, and return error if TimeErr is too great
    TtFull = DistM * 10 / (Vp * .2997925)
    TimeErr(i% + 1) = (TtFull - NewTtFull) / NewTtFull
    DistVal(i% + 1) = Dist
    IF TimeErr(i% + 1) > 0 THEN EXIT FOR
NEXT i%

LOCATE 22, col%
PRINT "For VWC ="; Theta;
PRINT USING " and for Vp: .## "; Vp;
FOR j% = i% TO i% + 1
    LOCATE 22 + 1 + j% - i%, col%
    PRINT "could use DIST/DIV:"; DistVal(j%);
    IF FtMtrs = 1 THEN
        PRINT "ft";
    ELSE
        PRINT "m";
    END IF
    PRINT USING ". Error: ###"; TimeErr(j%) * 100;
    PRINT "%";
NEXT j%
END SELECT
REDIM TimeErr(0)
REDIM DistVal(0)
END SUB

```

8 **TEKTRONIX¹ 1502 MODIFICATION for WAVEFORM OUTPUT**

When equipped with the X-Y Output Module, the Tektronix model 1502 TDR cable tester will provide analog outputs suitable for driving a chart recorder. These outputs consist of a ramping DC voltage for the X-axis signal and a variable DC voltage between about 0 and 1 VDC that is the Y-axis signal corresponding to the waveform display on the screen. The waveform is output over a 20-s interval after the toggle switch on the 1502 is depressed. This note describes a modification that will allow the TACQ.EXE program to toggle the output electronically using one pin of the computer's parallel port. When used with a suitable analog to digital conversion device, this allows the waveform to be digitized by the computer that is running TACQ. The toggling modification will be presented first, followed by two suggestions for analog to digital conversion that TACQ is able to use.

8.1 **Modifying the Tektronix 1502 for Digital Toggling of Waveform Output**

8.1.1 **Parts List**

Tektronix model 1502 TDR cable tester

X-Y Output Module for the cable tester

22 or 24 gage solid, insulated wire

Two 4-40 by ½ inch screws for mounting the relay circuit board to the bottom of the X-Y Output Module, and four to six 6-32 nuts for spacers between the circuit boards

Relay circuit board for toggling output. See Figures 8-1 to 8-3 below

Mylar plastic film for insulating relay circuit board

Optoisolator, GEH11AA1 or ECG3041 or TIL113 or MOC3030, or equivalent, 6 pin

Relay, 5 VDC, SPST, Radio Shack 275-232 reed relay or equivalent

4.7 kΩ resistor, 5%, carbon film

1 kΩ resistor, 5%, carbon film

NPN transistor, 2N2222 or ECG123A or equivalent

Switching diode, 1N914 or equivalent

One meter of four conductor stranded, 22 or 24 gage, tinned copper, shielded cable.

¹The mention of trade or manufacturer names is made for information only and does not imply an endorsement, recommendation, or exclusion by USDA-Agricultural Research Service.

Switchcraft DIN straight cord plug type 05CL5M with 30° locking ring, 5 pins at 180°. Bought from Allied Electronics, Inc., Tel:800-433-5003, part no. 932-0154.

Switchcraft DIN receptacle type 57HA5F, for locking ring plug, 5 contacts at 180°. Bought from Allied, part no. 932-0185. See page 308 in Allied catalog no. 956.

8.1.2 Relay Circuit Board

Gerber files for the relay circuit board are TOGGLE.001 and TOGGLE-F.001 and may be downloaded from <http://www.cprl.ars.usda.gov/programs>. Figures 8-1 through 8-3 show the solder and component sides of the board. The TOGGLE.001 and TOGGLE-F.001 files have three images of the circuit board for ganging on a single copper clad board. Files TOG1.001 and TOG1-F.001 are the same but have only one image of the circuit. This is really a single sided board so only the solder side is strictly necessary. If it is not feasible to produce the single-sided printed circuit board, a piece of perf-board may be substituted with insulated wires replacing the circuit board traces.

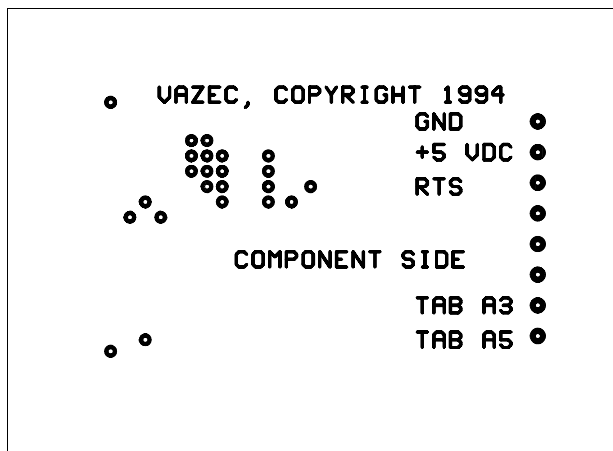

Fig. 8-1. Component side of the toggle relay PCB.

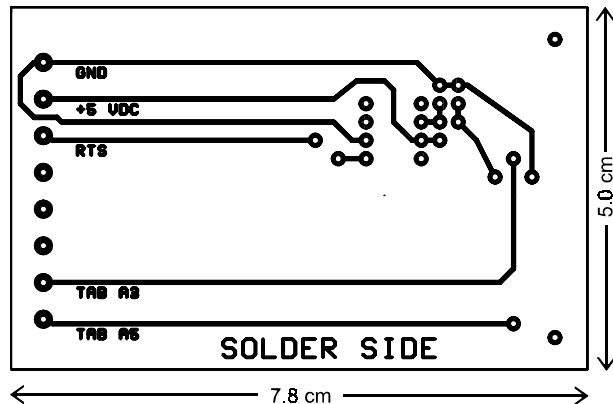

Fig. 8-2. Solder side of the toggle relay PCB.

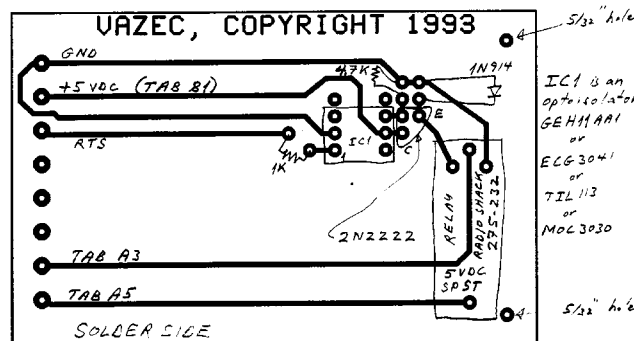

Fig. 8-3. Components and connections for the toggle relay PCB.

8.1.3 Assembly

The Switchcraft DIN plug is wired at one end of the shielded cable as follows. Connections should correspond to the positions shown for the DIN socket (receptacle) in Fig. 8-4.

| <u>Pin Number</u> | <u>Color</u> | <u>Use</u> | |
|-------------------|--------------|------------|-----------------------------------------------------------------------------------------------------------------------------------------------------------------------|
| 1 | White | RXD | Unused or connected to the RXD pin of the computer's serial port if used with the DATAQ DI-130 A/D device (see 8.4) |
| 5 | Black | DTR | Unused or connected to the DTR pin of the computer's serial port if used with the DATAQ DI-130 A/D device |
| 3 | Green | GRND | Connected to ground pin of the computer's parallel port, or to the ground pin of the computer's serial port if used with the DATAQ DI-130 A/D device. |
| 4 | Red | RTS | Toggle signal, connected to pin 5 of the computer's parallel port, or connected to the RTS pin of the computer's serial port if used with the DATAQ DI-130 A/D device |

The Switchcraft DIN socket is mounted in the face of the X-Y Output Module through a hole (about 1/2 inch) drilled in the face (Fig. 8-4). Use a set punch to dimple the face of the Module just above the word TEKTRONIX and centered between the R and O. Be sure that the Module is setting face up on the edge of a table and positioned so that the card edge connector (circuit board) is not taking the force of the blow. Lay the module on the table top on its side with the face plate overhanging the edge of the table and clamp the Module to the table top. Drill a 1/8 inch diameter pilot hole followed by a 1/4 inch hole, followed by successively large holes until the finish diameter is achieved. Set the module face up on the table's edge, again protecting the circuit board. Place the DIN socket in the hole and use the punch to mark one of the two screw holes. Drill the screw hole. Place the DIN socket in the large hole again and place and tighten the first screw. Now drill the second screw hole. Take the DIN socket out of the hole and solder four 20 cm long wires to the appropriate lugs as shown in Fig. 8-4. If the DATAQ DI-130 A/D device (see section 8.4) is not used then solder wires only to the lugs labeled RTS and GND in Fig. 8-5.

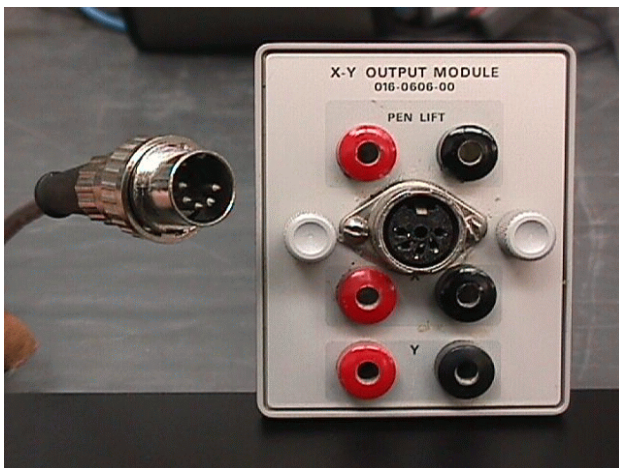

Fig. 8-4. DIN socket mounted in front of X-Y Output Module, and DIN plug on cable.

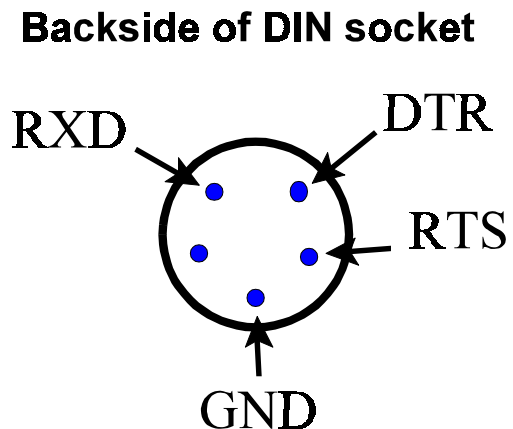

Fig. 8-5. Rear side of DIN socket.

Thread the wires through the ½ inch hole. The GND wire goes to the grounding lug on the bottom side of the circuit board of the X-Y Output Module. The RTS wire goes to the relay circuit board for toggling the 1502 to output a wave form (see relay circuit board below). Place the DIN socket in the ½-inch hole and use round head machine screws to bolt it to the face of the X-Y Output Module.

Place the X-Y Output Module on the table with the face towards you and the card edge connector facing away from you. The card edge connector has 20 gold tabs. Numbering the top set of tabs A1 through A10 from left to right you will see that tabs numbered A8, A9 and A10 are connected to traces on the circuit board. Numbering the bottom set of tabs B1 through B10 from left to right you will see that tabs B1, B8, B9 and B10 are connected to traces on the bottom side of the circuit board. Tabs A3 and A5 are unused. Drill a 1/16 inch hole through the circuit board about 1/16 inch behind tabs A3 and A5. Wires from tabs A3 and A5 will be connected to the relay circuit board. Strip and bend a 20 cm length of 22 gauge wire so that it comes up through a hole and just touches the back side of the gold tab. Solder the wire in place. Repeat for the other hole. Be careful not to put too much solder on the tab as this will interfere with the tabs seating fully with the card edge connector inside the cable tester (Fig. 8-6).

There is a grounding lug on the bottom side of the circuit board of the X-Y Output Module. Strip and tin the ends of a 20 cm wire and solder to the grounding lug (Fig. 8-7). This will connect to the relay circuit board. Strip and tin the ends of a 20 cm wire. Follow the circuit board trace that leads from tab B11 along the bottom side of the X-Y Output Module circuit board to one end of a resistor. This is the 5 VDC power line. Turn over the X-Y Output Module, and solder the wire to the end of the resistor that connects to this trace.

Drill 5/32 inch holes in the relay circuit board as indicated in the drawing. Solder the components into the relay circuit board as indicated in the drawing. Solder the wires from tabs A3 and A5 into the holes labeled A3 and A5 on the drawing. Solder the wire from the lug on the DIN socket that is labeled RTS in the drawing to the pad labeled RTS on the relay circuit board drawing.

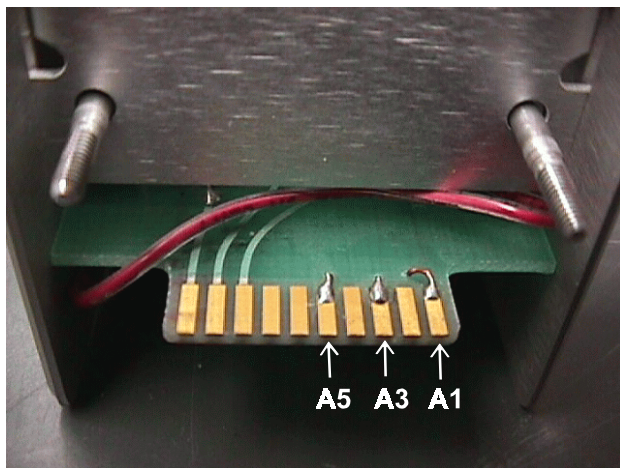

Fig. 8-6. Card edge connector of X-Y Output Module. The wire to tab A1 is used to provided power to an analog to digital conversion device described in Section 8.2.2.2.

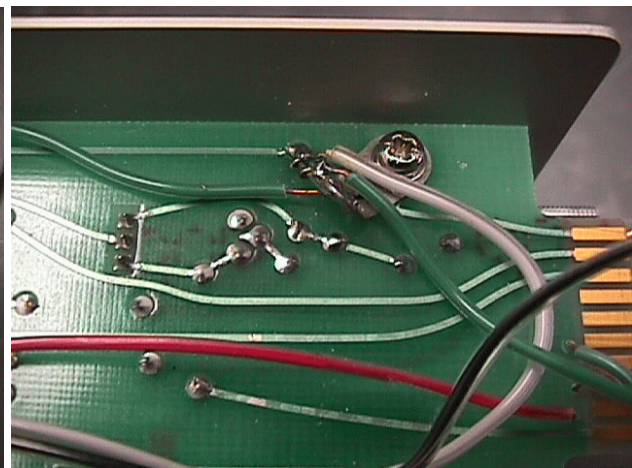

Fig. 8-7. Grounding lug on bottom side of X-Y Output Module circuit board.

Solder the wire that is connected to the grounding lug of the Module to the pad labeled GND on the relay circuit board drawing. Solder the wire that was connected to 5 VDC power (resistor on trace to tab B11) to the pad labeled +5 VDC on the relay circuit board (Fig. 8-8). Tape a piece of mylar plastic film over the solder side of the relay circuit board. There are four screws holding the X-Y Output Module circuit board in place. Remove the the two screws nearest the face plate and mount the relay circuit board below the Module circuit board using two longer screws. Use two slightly larger nuts between the circuit boards as spacers. Fold the excess wire out of the way, preferably between the two circuit boards.

Remove the battery pack and the case from the cable tester after loosening the four screws in the two feet at the rear of the cable tester. Remove the two Al shields to expose the internal circuitry. Inside the cable tester, solder wires to the other side of the card edge connector

corresponding to the wires that you have just soldered to the Output Module. Do this by removing the four mounting screws from the power supply board and moving the board out of the way so that you can get to the back side of the card edge connector. You may have to remove some of the wires plugged into the top of the power supply board in order to move it. Make sure you know how they go so they can be replaced later. Look below the power supply board and note the positions of the wires plugged into the bottom of the board. These sometimes come loose when the board is moved and you should know how they are connected so that you can check the connections when putting the board back in place. A strategically placed small screwdriver may serve to wedge the board out of the way while you are soldering. Strip and tin about 1/4 inch of 22 gauge solid wire, 40 cm long. Put a hook in the tinned end and use this to hook the lug on the backside of the card edge connector corresponding to tab A3. Pull the lug slightly upward to separate it from its neighbors and wrap the wire around some convenient part of the cable tester to keep tension on the wire (or have someone hold it for you). Using a small soldering iron, solder the wire to the lug. Repeat for the lug corresponding to tab A5. Replace the power supply circuit board making sure all connections are good. Route the long wires through the cable tester to the bottom side next to the toggle switch.

Remove the toggle switch from the face of the cable tester by unscrewing the rubber boot from the front side. The switch is sealed in place with silicone sealant and may be troublesome to remove. Do not remove any of the wires. Refer to Fig. 8-9 showing the backside of the switch. Note the two cross bars soldered between lugs on the back of the switch. The drawing shows these and you should be able to find lugs 1 and 3 as numbered in the drawing. Solder one of your wires (from tabs A3 and A5 of the card edge connector) to lug 1 and the other to lug 3 of the toggle switch. The polarity doesn't matter since this is a simple shorting circuit. Replace the switch, using a dab of silicone sealant (RTV) to re-seal it.

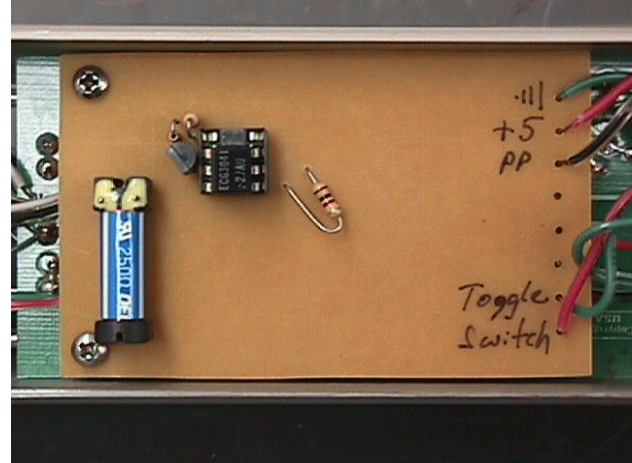

Fig. 8-8. The relay circuit board installed on the bottom of the X-Y Output Module. On the right side, from top to bottom, wires are connected to the grounding lug, to the resistor that is connected to tab B-11, to the RTS line (labeled PP here) on the DIN plug, and to tabs A3 and A5.

8.1.4 Testing

Test the circuit before connecting power. Plug the X-Y Output Module into the cable tester. Check resistance across the lugs 1 and 3 of the toggle switch. This resistance should be quite high ($M\Omega$) indicating an open circuit. Check resistance between each lug and the cable tester chassis. Again the resistance should be quite high indicating an open circuit. Check resistance between the “battery” lug on the power supply board and the chassis. This resistance should be very high indicating an open circuit. Replace the chassis in the cable tester case and plug in a charged battery pack. Do not use AC power, the battery pack has a fuse on it that will protect the cable tester. Turn on the cable tester and check to see if there is a line on the screen. Push the toggle switch to see if the line turns into a slowly moving dot that crosses the screen from left to right.

Connect the cable between the parallel port (or serial port if using the DATAQ DI-130) of the computer and the DIN connector on the X-Y Output Module. Run TACQ.EXE under DOS (not a DOS window under Windows 3.X or 9X, not even full screen) and press S to enter Software Setup. Press T to choose a TDR instrument and then A to enter the Advanced menu. Choose the “Computer Boards CI08 A/D card” by pressing the Enter key when that choice is displayed. A series of setting options will be displayed. At this time you may choose the defaults by pressing the Enter key. Also in Software Setup, configure the parallel port to use pin 5 to toggle the cable tester. Return to the main menu of TACQ and you will see an enhanced menu with an option to toggle waveform output from a Dynamax-modified 1502. Press T to toggle the cable tester. You should again see the slowly moving dot on the cable tester screen.

8.2 Digitizing the Waveform

The Y-axis output of the X-Y Output Module may be digitized in any number of ways to produce a computer readable data file representing the waveform. The TACQ program is written to use two models of analog to digital (A/D) conversion hardware, the Measurement Computing (Middleboro, MA, formerly ComputerBoards) model CI08 series or more recent versions of Measurement Computing A/D cards that are software equivalent, and the DATAQ Instruments, Inc. model DI-130 or equivalent more recent versions. The CI08 gives better timing between data points and is recommended. It also may be used to measure temperatures using thermocouples. Note that in TDR soil water content measurement, we convert the travel time of the step pulse to water content. The travel time is determined from the waveform; and, thus the waveform should accurately represent the distance (equivalent to time) between data points.

8.2.1 Using the Measurement Computing CI08 A/D Card

Installation of the CI08 is well-described by its manufacturer. Once installed in the computer, the Y-axis output and ground of the Output Module may be connected to the analog input of the

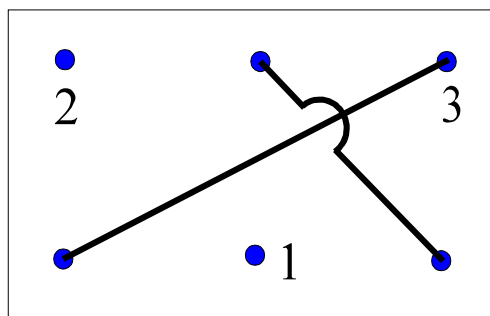

Fig. 8-9. Schematic of back side of toggle switch.

CI08. Twisted pair wiring is suggested. Banana plugs may be used to plug directly into the Output Module. Run TACQ and press S to enter Software Setup. Then press T to choose a TDR instrument, followed by pressing A to enter the Advanced menu. Press the up and down cursor keys to see the options. Choose the “Computer Boards CI08 A/D card” by pressing the Enter key when that choice is displayed. A series of setting options will be displayed. Pay particular attention to the base address of the CI08 (see manufacturer’s documentation). The default settings are for a CI08 used in conjunction with a Measurement Computing model MUX-32 multiplexer board. If you are not using the multiplexer you may need to change some of the settings. Note that the Measurement Computing parallel port A/D device and the National Instruments and Data Translation A/D devices are not supported in the current version of TACQ.

Connect a TDR probe to the cable tester and use the distance knob to display the probe wave form on the screen. Press “B” at the main menu of TACQ to acquire the wave form and check the acquired wave form against that shown on the cable tester screen.

Measurement Computing can be reached at www.computerboards.com or

Measurement Computing
(Formerly, ComputerBoards, Inc.)
16 Commerce Blvd.
Middleboro, MA 02346
USA

Tel: 508-946-5100
FAX: 508-946-9500

8.2.2 Using the DATAQ Instruments Serial Data Acquisition Module

8.2.2.1 Parts List

Tektronix model 1502 TDR cable tester.

X-Y Output Module for the cable tester.

DATAQ Instruments, Inc. model DI-130 serial data acquisition module. 150 Springside Drive, Suite B220, Akron, Ohio 44333-2473, Tel:800-553-9006, FAX:216-666-5434.

Switchcraft DIN straight cord plug type 05CL5M with 30° locking ring, 5 pins at 180°. Bought from Allied Electronics, Inc., Tel:800-433-5003, part no. 932-0154.

Switchcraft DIN receptacle type 57HA5F, for locking ring plug, 5 contacts at 180°. Bought from Allied, part no. 932-0185. See page 308 in Allied catalog no. 956.

One meter of four conductor stranded, 22 or 24 gage, tinned copper, shielded cable.

One 9 pin D-shell socket for connection to serial port of computer.

One 9 pin D-shell plug for connection to the DI-130.

One plastic hood for 9 pin D-shell socket.

22 or 24 gage solid, insulated wire.

Three screws for mounting DI-130 in X-Y output module, 4-40 or 6-32 by 3/8" flat head with nuts.

Two 4-40 by 1/2 inch screws for mounting relay circuit board to bottom of X-Y output module, and four to six 6-32 nuts for spacers between the circuit boards.

Parts for relay circuit board for toggling output. See section 8.1.1.

8.2.2.2 Assembly with DATAQ Hardware

The cable between the computer and DIN plug is constructed as describe above. The DIN plug is wired and mounted in the X-Y module of the Tektronix 1502 as described in section 8.3. The RTS wire is connected to the relay circuit board (Fig. 8-8) as described in section 8.1.3. The 20-cm wire connected to RXD on the DIN plug (if wired per section 8.1.3) should now be connected to pin 2 of the 9-pin D-shell plug. Note that this 9-pin plug will be on the inside of the X-Y Output Module so that it can be plugged into the DI-130. The 20-cm wire connected to DTR on the DIN plug should now be connected to pin 4 of the 9-pin plug. A separate wire should be connected between the grounding lug on the bottom side of the circuit board of the X-Y Output Module and pin 5 of the 9-pin plug. The wire connected to the grounding lug on the X-Y Output Module is thus also connected to the GND pin on the DIN plug (see section 8.1.3). Pin 1 of the 9-pin plug should be connected to power that you will connect to tab A1 of the card edge connector of the X-Y Output Module. Instructions for wiring the card edge connector appear below.

The DI-130 is mounted in the top of the X-Y Output Module (Fig. 8-10). Its plastic case will just slip inside the aluminum side walls of the X-Y Output Module. Position the case inside the top of the Output Module, with the top of the plastic box just below the top of the aluminum sides of the Output Module, and clamp it to the Module with a small C-clamp. Drill holes through the aluminum and plastic case near the top, avoiding the components inside the case. It is easy to find a spot to drill three holes, two on one side and one on the other. This is enough for rigid mounting. Remove the DI-130 and clean any debris out of it. Counter sink the holes in the outside of the X-Y Output Module to recess the heads of the flat head screws.

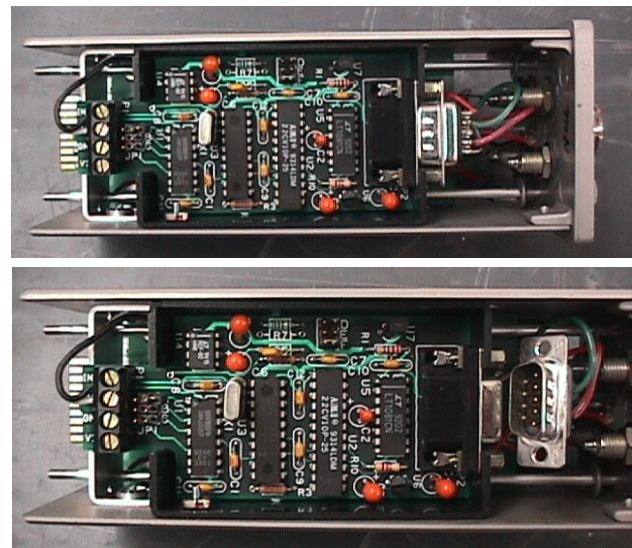

Fig. 8-10. The DI-130 A/D module installed in the X-Y Output Module. Top photograph is with the 9-pin D-shell plug connected to the DI-130. Bottom is with it unplugged.

Place the Output Module on the table with the face towards you and the card edge connector facing away from you. The card edge connector has 20 gold tabs. Numbering the top set of tabs A1 through A10 from left to right you will see that tabs number A8, A9 and A10 are connected to traces on the circuit board. Numbering the bottom set of tabs B1 through B10 from left to right you will see that tabs B1, B8, B9 and B10 are connected to traces on the bottom side of the circuit board. Drill a 1/16 inch hole through the circuit board about 1/16 inch behind and to one side of tab A1. Be careful to avoid the trace that is connected to tab B1 on the other side of the circuit board. A wire from tab A1 will carry battery power to the DI-130. Strip and bend a 20-cm length of 22 gauge wire so that it comes up through the hole and just touches the back side of the gold tab. Solder the wire in place (Fig. 8-6). Be careful not to put too much solder on the tab as this will interfere with the tab seating fully with the card edge connector socket inside the cable tester. Solder the wire that was connected to tab A1 to pin 1 of the 9-pin plug that will connect to the DI-130. This will supply unregulated 12 VDC battery power to the DI-130, which has its own 5 VDC regulator. Strip and tin two 20-cm lengths of wire and solder one to the wire connected to the X-Y Output Module circuit board at the pad labeled Y (this is the wire connected to the red Y output on the face of the Module). Solder the other wire to the wire connected to the pad labeled GND that is next to the pad labeled Y. This is the analog ground. Do not solder this to any other ground nor to chassis ground.

Plug the 9 pin connector, previously wired to the DIN socket, into the DI-130. Place the DI-130 in the Output Module, carefully folding the wires underneath it, and bolt it into place with the flat head machine screws. Connect the wire from the Y output ground to the minus input of the DI-130 (labeled IN -). Connect the wire from the Y output (pad labeled Y on the Module circuit board) to the plus input of the DI-130 (labeled IN +). This is a differential input. Test the modified X-Y Output Module as follows. Check resistance between the plus input and chassis ground and between the minus input and chassis ground. These should indicate open circuits. There should also be open circuits between all of the other connections that you made and chassis ground except for the GND connection on the relay circuit board and the GND connection on the 9 pin plug that is plugged into the DI-130.

Before proceeding, ensure that the cable tester is not connected to AC power (not plugged in), and remove the battery pack if present. Remove the case as described in section 8.1.3. Inside the cable tester, solder a 15-cm wire to the other side of the card edge connector corresponding to the wire that you have just soldered to tab A1 of the Output Module. Do this by removing the four mounting screws from the power supply board and moving the board out of the way so that you can get to the back side of the card edge connector. You may have to remove some of the wires plugged into the top of the power supply board in order to move it. Make sure you know how they go so they can be replaced later. Look below the power supply board and note the positions of the wires plugged into the bottom of the board. These sometimes come loose when the board is moved and you should know how they are connected so that you can check the connections when putting the board back in place. A strategically placed small screwdriver may serve to wedge the board out of the way while you are soldering. Strip and tin about 1/4 inch of 22 gauge solid wire, 15 cm long. Put a hook in the tinned end and use this to hook the lug on the backside of the card edge connector corresponding to tab A1. Pull the lug slightly upward to separate it from its neighbors and wrap the wire around some convenient part of the cable tester to keep tension on the wire (or have someone hold it for you). Using a small soldering iron, solder the wire to the lug. Replace the power supply circuit board making sure all connections are good. Now solder the other end of the 15-cm wire to the “battery” connection on the power supply board. This is a source of unregulated 12 VDC power.

Connections for the relay circuit board should have already been made inside the cable tester per section 8.1.3.

8.2.2.3 Testing

Test the circuit before connecting power. Plug the X-Y Output Module into the cable tester. Check resistance across the lugs 1 and 3 of the toggle switch. This resistance should be quite high ($M\Omega$) indicating an open circuit. Check resistance between each lug and the cable tester chassis. Again the resistance should be quite high indicating an open circuit. Check resistance between the “battery” lug on the power supply board and the chassis. This resistance should be very high indicating an open circuit. Replace the chassis in the cable tester case and plug in a charged battery pack. Do not use AC power, the battery pack has a fuse on it that will protect the cable tester. Turn on the cable tester and check to see if there is a line on the screen. Push the toggle switch to see if the line turns into a slowly moving dot that crosses the screen from left to right. Connect the cable between the serial port of the computer and the DIN connector on the X-Y Output Module and use the TACQ.EXE program to toggle the cable tester. You should again see the slowly moving dot on the cable tester screen. Connect a TDR probe to the cable tester and use the distance knob to display the probe wave form on the screen. Press “B” at the main menu of TACQ to acquire the wave form and check the acquired wave form against that shown on the cable tester screen.