

USER'S MANUAL

FOR

TTG-7000 TCAS\TRANSPONDER

RF GENERATOR

1. OVERVIEW	5
2. HARDWARE	8
3. TOUCHSCREEN APPLICATION	12
3.1. MAIN MENU	12
3.1.1. SYSTEM MENU	16
3.1.1.1. Software Update Menu	18
3.1.1.2. Network Connections Menu	20
3.1.2. TCAS MAIN MENU	23
3.1.2.1. TCAS Settings Menu	25
3.1.2.2. TCAS Own Aircraft Menu	28
3.1.2.3. TCAS Receiver Menu	32
3.1.2.3.1. TCAS Receiver Filtered Masked Menu	35
3.1.2.3.2. TCAS Receiver Highlight Masked Menu	37
3.1.2.4. TCAS Transmitter Menu	39
3.1.2.4.1. RTCA/DO-260 Tests	40
3.1.2.4.2. Block Transmission	52
3.1.2.5. TCAS Scenario Menu	56
3.1.2.5.1. Static Mode S TCAS Only Definition Menu	59
3.1.2.5.1.1. Coordination Message Menu	62
3.1.2.5.1.2. Broadcast Message	65
3.1.2.5.1.3. Coordination Replies (DF16 Replies)	68
3.1.2.5.1.4. UFO Messages	70
3.1.2.5.2. Dynamic Mode S TCAS Only Definition Menu	72
3.1.2.5.3. Static Mode C Definition Menu	75
3.1.2.5.4. Dynamic Mode C Definition Menu	78
3.1.2.5.5. Static Mode S Extended Definition Menu	81
3.1.2.5.5.1. Mode S Squitter Definition	85
3.1.2.5.5.2. Position Squitter Definition Menu	86
3.1.2.5.5.3. Velocity Squitter Definition Menu	87
3.1.2.5.5.4. Ident Squitter Definition Menu	89
3.1.2.5.5.5. BDS Register Definition Menu	91
3.1.2.5.6. Dynamic Mode S Extended Definition Menu	92
3.1.2.5.7. Static TIS-B Definition Menu	96
3.1.2.5.8. Dynamic TIS-B Definition Menu	99
3.1.2.5.9. Static ADS-R Definition Menu	102

3.1.2.5.10.	Dynamic ADS-R Definition Menu	105
3.1.2.5.11.	TCAS Display Menu	108
3.1.2.5.12.	TCAS Ground Station Menu	109
3.1.2.5.13.	TCAS ATCRBS Pulse Information Menu	112
3.1.2.5.14.	TCAS Mode S Pulse Information Menu	114
3.1.2.5.15.	TCAS Video Blocks Menu	116
3.1.2.6.	TCAS ATE Line Menu	121
3.1.2.7.	TCAS Chamber Mode Menu	123
3.1.2.8.	MEASUREMENT MENU	125
3.1.3.	TRANSPONDER MENU	129
3.1.3.1.	Transponder Settings	130
3.1.3.2.	Transponder Mode A Menu	132
3.1.3.3.	Transponder Mode C Menu	134
3.1.3.4.	Transponder Mode A All-Call Menu	136
3.1.3.5.	Transponder Mode C All-Call Menu	138
3.1.3.6.	Transponder Mode A/Mode S All-Call Menu	140
3.1.3.7.	Transponder Mode C/Mode S All-Call Menu	142
3.1.3.8.	Transponder Mode S Menu	144
3.1.4	UAT MENU	146
3.1.4.1.	UAT Settings	147
3.1.4.2.	UAT Receiver Menu	149
3.1.4.3	UAT Receiving Station Menu	152
3.1.4.3.	UAT Scenario Menu	154
3.1.4.4.1	UAT Target Definition Menu	156
3.2.	HOW TO ...	164
3.2.1.	HOW TO CHANGE GPIB ADDRESS	164
3.2.2.	HOW TO CHANGE TRANSMITTER FREQUENCY	164
3.2.3.	HOW TO SET A SCOPE OUTPUT	164
3.2.4.	HOW TO PROGRAM DSP SOFTWARE OR FPGA FIRMWARE	164
3.2.5.	HOW TO INSTALL THE TTG-7000C RF AMPLIFIER	165
3.2.6.	HOW TO ENTER OWN AIRCRAFT INFORMATION	165
3.2.7.	HOW TO SETUP A STATIC ATCRBS INTRUDER	165
3.2.8.	HOW TO SETUP A DYNAMIC ATCRBS INTRUDER	167
3.2.9.	HOW TO SETUP A STATIC MODE S INTRUDER	168
3.2.10.	HOW TO SETUP A DYNAMIC MODE S INTRUDER	170
3.2.11.	HOW TO SETUP A STATIC MODE S EXTENDED INTRUDER	171
3.2.12.	HOW TO SETUP A DYNAMIC MODE S EXTENDED INTRUDER	173
4.	REMOTE CONNECTION (VNC)	176

1. Overview

The TTG-7000 TCAS\Transponder RF Generator is a test set that can be used to perform RF test of a TCAS, Transponder or UAT system. The TTG-7000 contains two Receivers (Top/Bottom), six Transmitters (6 with pulse modulation capability and three with BPSK capability for UF interrogations), and an Antenna Simulator.

The TTG-7000 was designed to allow operators to perform most DO-185, DO-181, DO-260, and DO-300 tests.

The TTG-7000 has the capability of simulating ATRCBS, Mode S Only, Mode S Extended (ADS-B), and ADS-B Only (DF18) aircrafts. The test set can simulate up to 32 dynamic intruders and 568 static intruders.

The TTG-7000 can be controlled from the front panel touch screen display or via commands from USB, GPIB, or TCP/IP.

The TTG-7000 test set performs special software applications not shown in this document that are Customer specific.

TTG-7000 Specifications	
<u>Transmitter Specification:</u>	
Frequency:	
Range:	962 to 1213 MHz
Resolution:	100 KHz
Accuracy:	+/- 10 KHz
Power:	
Range:	-20 to -90 dBm per element (Low Power Mode) [TCAS and Transponder] +1 to -69 dBm per element (High Power Mode) [TCAS] +1 to -98 dBm [UAT]
Resolution:	1 dB
Accuracy:	+/- 1 dB, typically < +/- 0.5 dB
Chamber Mode:	+10 to -60 dBm (TTG-7000 with TTG-7000C)
Port:	Top (4 Elements), Bottom (4 Elements), Any Individual Element
Calibration:	Calibrated at 1090, 1030, and 978 (UAT option unit) MHz Calibration performed on top/bottom (All ports active)
Pulse Modulation:	
Accuracy:	+/- 0.05 uS
On/Off Ratio:	>80dB

Rise/Fall Time:	Normal (<50 nS)/Slow (600 nS)
Bearing Simulation:	
Range:	0 to 359°
Resolution:	1°
Accuracy:	Typical <+/- 1°, max +/- 3° (4 Port Simulation)
Range Simulation:	
Range:	0 to 150 NMI
Resolution:	12.5 Feet
Accuracy:	+/- 200 Feet
Velocity Simulation:	
Range:	+/- 2000 Kt/Hr
Resolution:	1 Kt/Hr
Accuracy:	+/- 1 Kt/Hr
Vertical Speed Simulation:	
Range:	+/- 32608 Ft/Min
Resolution:	64 Ft/Min
Accuracy:	+/- 64 Ft/Min
Altitude Simulation:	
Range:	-1000 to 126700 Feet
Mode:	Gilham and 25 Feet
Resolution:	25/100 Feet up to 50175 Feet 100 Feet above 50175 Feet
<u>Receiver Specifications:</u>	
VSWR:	<1.4
Maximum Input Power:	+60 dBm
Antenna Simulation:	Internal with Antenna Resistors for ACSS, Collins, and Honeywell
Receivers:	1030 MHz with BPSK Demodulation 1090 MHz 978 MHz [UAT Option]
Dynamic Range:	40 dB
Dual Receiver:	Top/Bottom
Power Measurement:	
Range:	+17 to +57 dBm

Resolution: 0.1 dB
Accuracy: 1 dB

Relative Phase Measurement:

Range: 0 to 359 degrees
Resolution: 1 degree
Accuracy: +/- 4 degrees

Frequency Measurement:

Resolution: 0.2 KHz
Accuracy: 1 KHz
Using Special Test Mode

Pulse Characteristic Measurement:

Resolution: 10 nS

Software Interfaces:

Ethernet
GPIB
USB 2.0
VNC Viewer

Interfaces:

Suppression Bus (Front/Rear)
ATE Lines (Front/Rear)
429 Tx/Rx (Front/Rear)
Two Scope Outputs (Front/Rear)
LAN (Front/Rear)
USB Type B Control (Front)
Two USB Type A (Front) for Peripherals (Flash Disk, HID ...)
Six External I/O Ports (Rear) [Application Specific]
Top/Bottom RF Coupled Outputs

2. Hardware

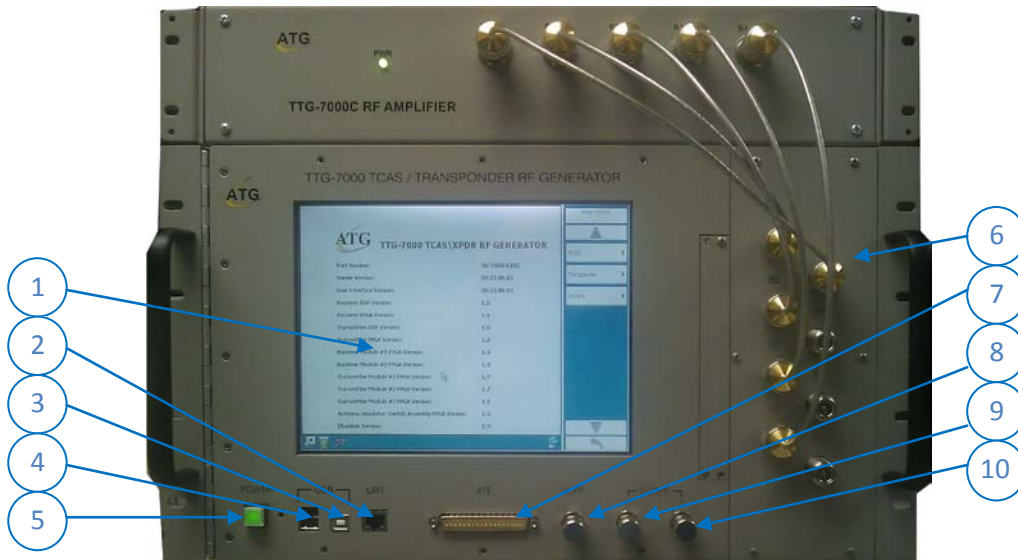

Figure 2.1 – TTG-7000 TCAS\Transponder RF Generator with Chamber RF Amplifier (TTG-7000C)

TTG-7000 Front Interfaces

- 1 Color LCD Touch Screen Display
- 2 Ethernet RJ-45 jack for remote control of test set via TCP/IP. Another RJ-45 jack is provided in the rear.
- 3 USB Type B jack for remote control of test set.
- 4 Two (2) USB Type A jacks for interface to external USB devices (Keyboards, mouse, flash drives..)
- 5 Power Switch and Indicator
- 6 Eight (8) Antenna Ports. T1/T2/T3/T4/B1/B2/B3/B4
- 7 ATE Line input. This connection is also available in the rear. It contains discrete inputs, discrete outputs, and 429 Tx/Rx.
- 8 Suppression Input/Output
- 9 Scope Channel 1
- 10 Scope Channel 2



Figure 2.2 – TTG-7000 TCAS\Transponder RF Generator (Rear)

TTG-7000 Front Interfaces

- 1 Ethernet RJ-45 jack for remote control of test set via TCP/IP. Another RJ-45 jack is provided in the front.
- 2 Spectrum Analyzer Output. Coupled output from the Top Receiver. SMA Jack
- 3 Spectrum Analyzer Output. Coupled output from the Bottom Receiver. SMA Jack
- 4 Aux Control Port. D-Sub 25 Pin Female. [TTG-7000C Interface Port]
- 5 External I/O Ports 1-6. BNC Jack [Application Specific]
- 6 Scope Channel 1
- 7 Scope Channel 2
- 8 Suppression Input/Output
- 9 ATE Line Port. D-Sub 37 Pin Male.
- 10 GPIB Bus Port
- 11 Fan
- 12 Power Supply. 115/230 VAC, 50/60 Hz

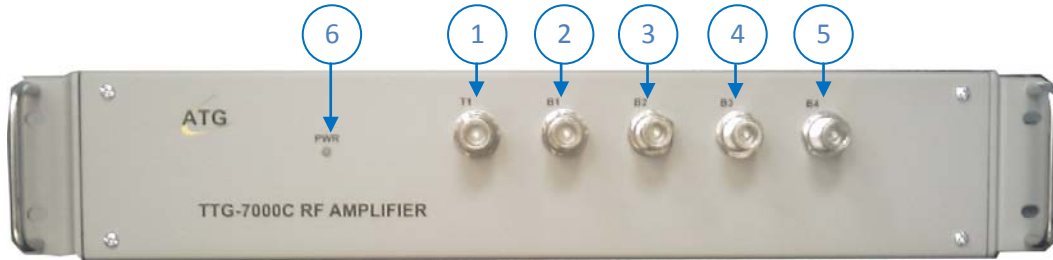

Figure 2.3 – TTG-7000C RF Amplifier (Chamber) Front

- 1 T1 Port – Connect to TTG-7000 T1 Port (Receiver Port)
- 2 B1 Port – Connect to TTG-7000 B1 Port (Ground Station and UF Interrogations)
- 3 B2 Port – Connect to TTG-7000 B2 Port (Generator 1 Port)
- 4 B3 Port – Connect to TTG-7000 B3 Port (Generator 2 Port)
- 5 B4 Port – Connect to TTG-7000 B4 Port (Generator 3 Port)
- 6 Power Indicator

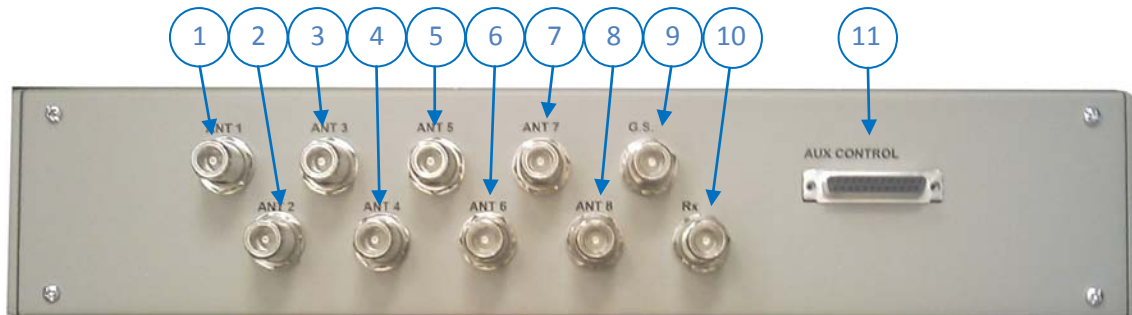

Figure 2.4 – TTG-7000C RF Amplifier (Chamber) Rear

- 1 Antenna 1 - 0° Port
- 2 Antenna 2 - 45° Port
- 3 Antenna 3 - 90° Port
- 4 Antenna 4 - 135° Port
- 5 Antenna 5 - 180° Port
- 6 Antenna 6 - 225° Port
- 7 Antenna 7 - 270° Port
- 8 Antenna 8 - 315° Port
- 9 GS – Ground Station and UF Interrogations Port
- 10 Rx – Receiver Port
- 11 Aux Control Port. D-Sub 25 Pin Female Jack. Connect to TTG-7000 Aux Control Port on rear. Connect cable with power off on TTG-7000.

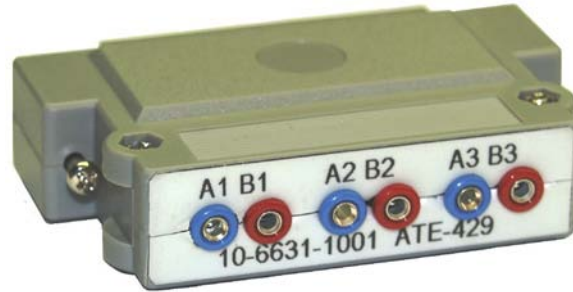

Figure 2.5 – TTG-7000 429 Input Adapter [Optional]

3. TouchScreen Application

3.1.Main Menu

Figure 3.1.1 illustrates the TTG-7000 Main Menu. The Main Menu shows status of test set configuration and software versions.

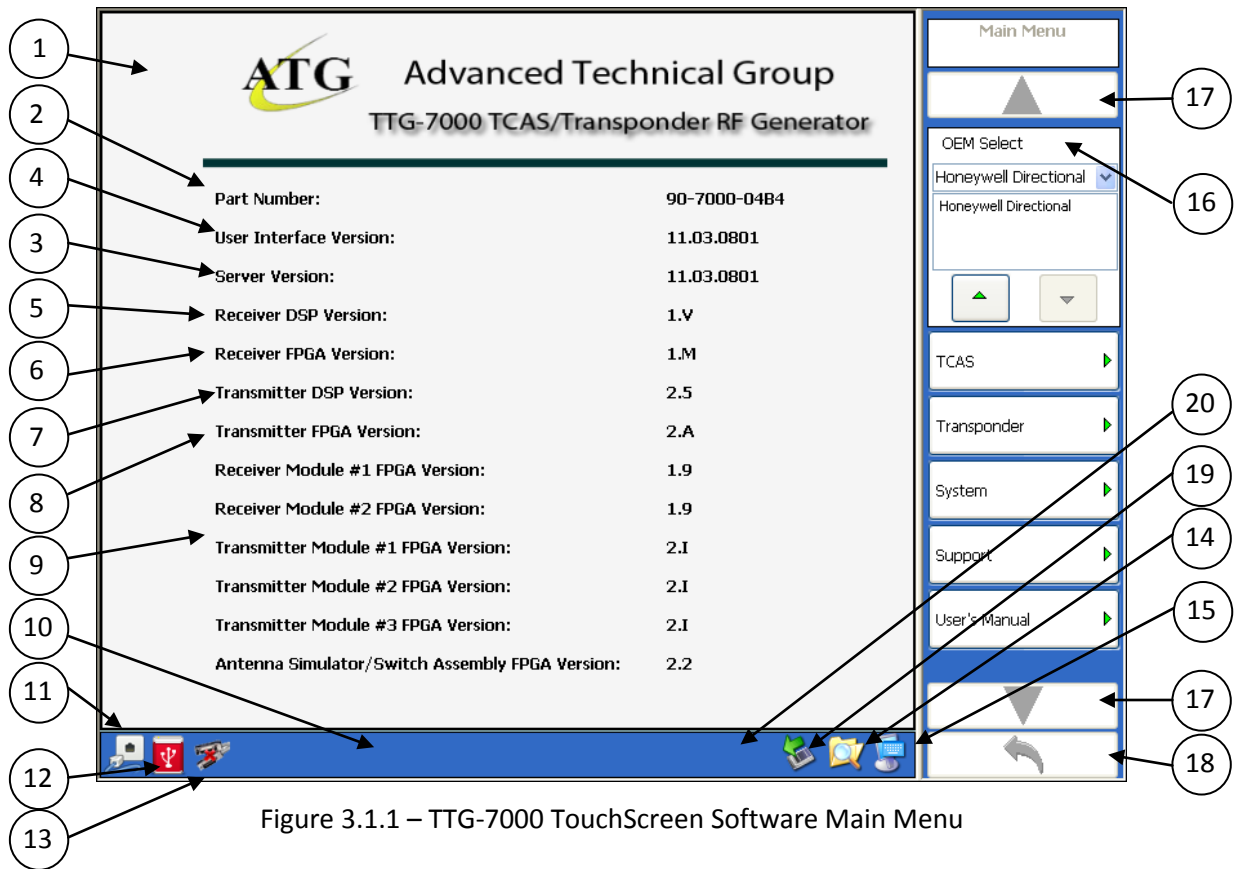

Figure 3.1.1 – TTG-7000 TouchScreen Software Main Menu

Menu Controls	Function
1	Shows status of the test set configuration and software version
2	The Unit Part Number is illustrated with the base number (90-7000) and the dash number provides the hardware version and the software version of the test set. The first two characters of the dash number represent the hardware version (04 in example in the Figure 3.1.1). The last two characters represent the software version (B4 in the example in Figure 3.1.1)
3	Server (Kernel) Software version

Menu Controls	Function
4	User Interface (TouchScreen) version
5	Receiver DSP embedded software version
6	I/O Controller Receiver FPGA firmware version
7	Transmitter DSP embedded software version
8	I/O Controller Transmitter FPGA firmware version
9	FPGA firmware version of all subassemblies present, including auxiliary equipment (i.e. Chamber Test Set if connected)
10	Status Menu (present on all TouchScreen menus)
11	Ethernet command reception status. Ethernet commands can be received either from the front or rear RJ-45 Ethernet ports.
12	USB control port status. Provides status whether or not the front USB Type B port for control could be configured.
13	GPIB command reception status.
14	Explorer Icon. Press this icon to open windows explorer. (In the example in Figure 3.1.2)
15	On Screen Keyboard Icon. Press this icon to open the on screen keyboard for data entry.
16	Menu Softkey Section. This section is contained in all menus. If a softkey button contains an arrow to the right, that softkey will open another menu.
17	Up/Down Softkey. The up/down arrows if not grayed illustrates that there exist more softkeys either up or down.
18	Return to Previous Menu Softkey. This softkey if not grayed allows the user to return to the previous menu.
19	Safely Remove Hardware Icon. Press this icon to open safely remove hardware dialog. (In the example in Figure 3.1.3)
20	Configuration warning triangle. This warning triangle is only illustrated if the configuration does not match with the subassemblies present in the system or a DSP or FPGA firmware version is incorrect. If Exclamation warning is illustrate then an error has occurred. Place the mouse cursor over the exclamation warning to get a description of the error.

Softkey	Function
TCAS Menu	Allows user to enter TCAS Menu.
Transponder Menu	Allows user to enter Transponder Menu.
System Menu	Allows user to enter System Menu.
UAT Menu	Allows user to enter UAT Menu. [Optional]
OEM Select	Allows selection of UUT OEM. Honeywell Directional Honeywell OMNI Collins Phase Directional Collins Phase OMNI Collins Magnitude Directional Collins Magnitude OMNI ACSS Directional ACSS OMNI Garmin Avidyne
Support Menu	If connection to the Internet is available, menu illustrates ATG TTG-7000 Support Page. Allows downloading of latest TTG-7000 software for update.
User's Manual	Illustrates a PDF copy of this manual on screen.

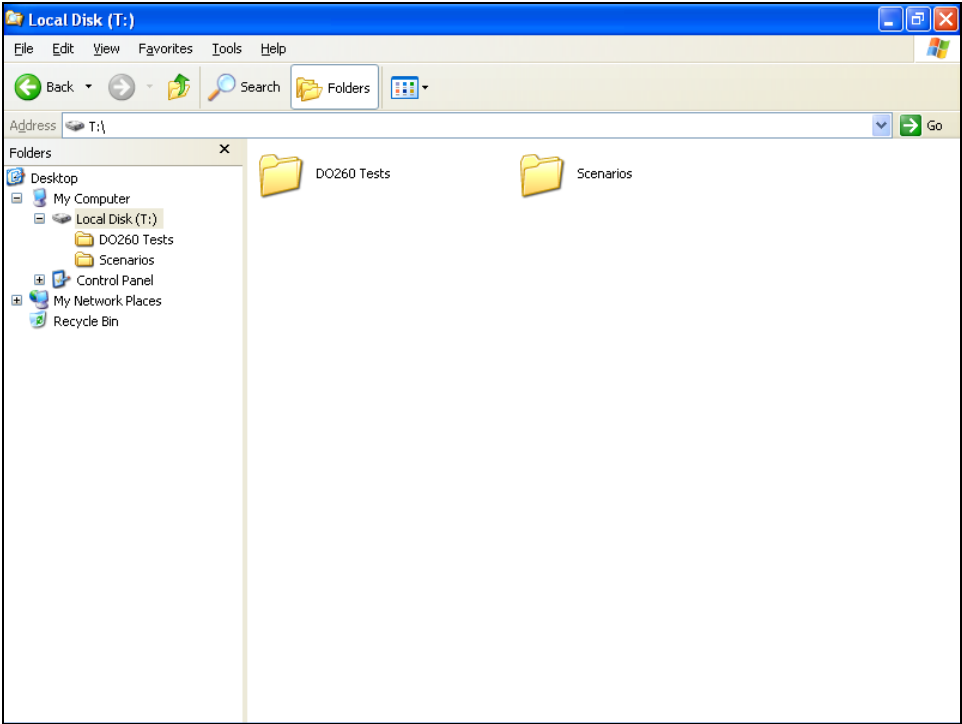

Figure 3.1.2 – Windows Explorer Icon.

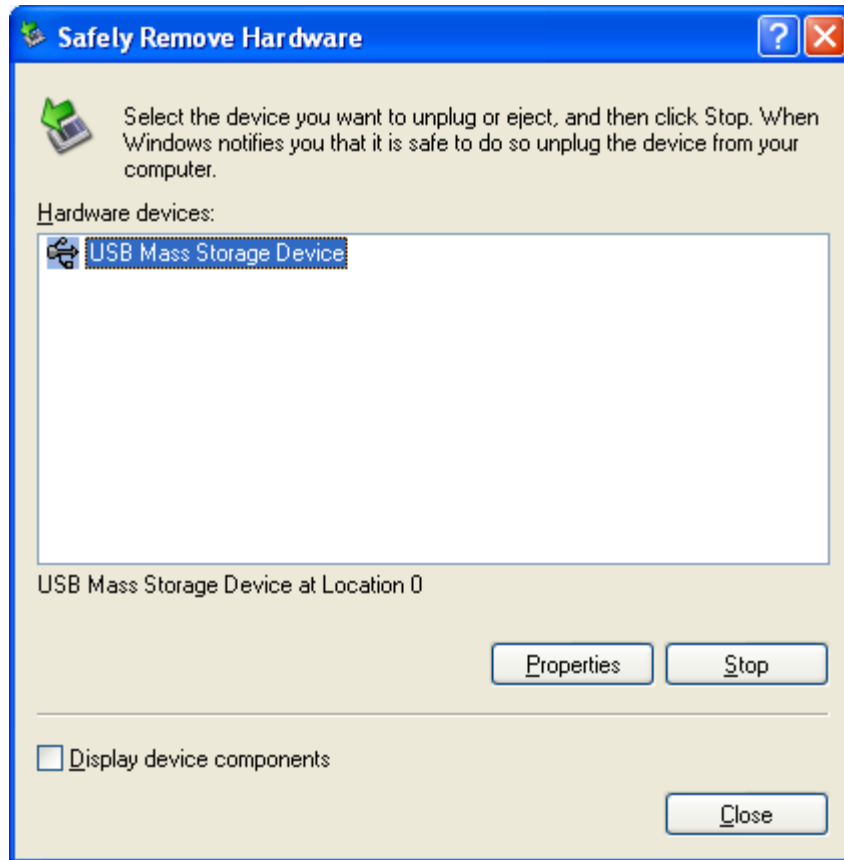

Figure 3.1.3 – Safely Remove Hardware Icon.

3.1.1. System Menu

Figure 3.1.1.1 illustrates the TTG-7000 System Menu. The System Menu allows the user to set different system parameters (i.e. GPIB address, Product Key, Scope Port Outputs ...).

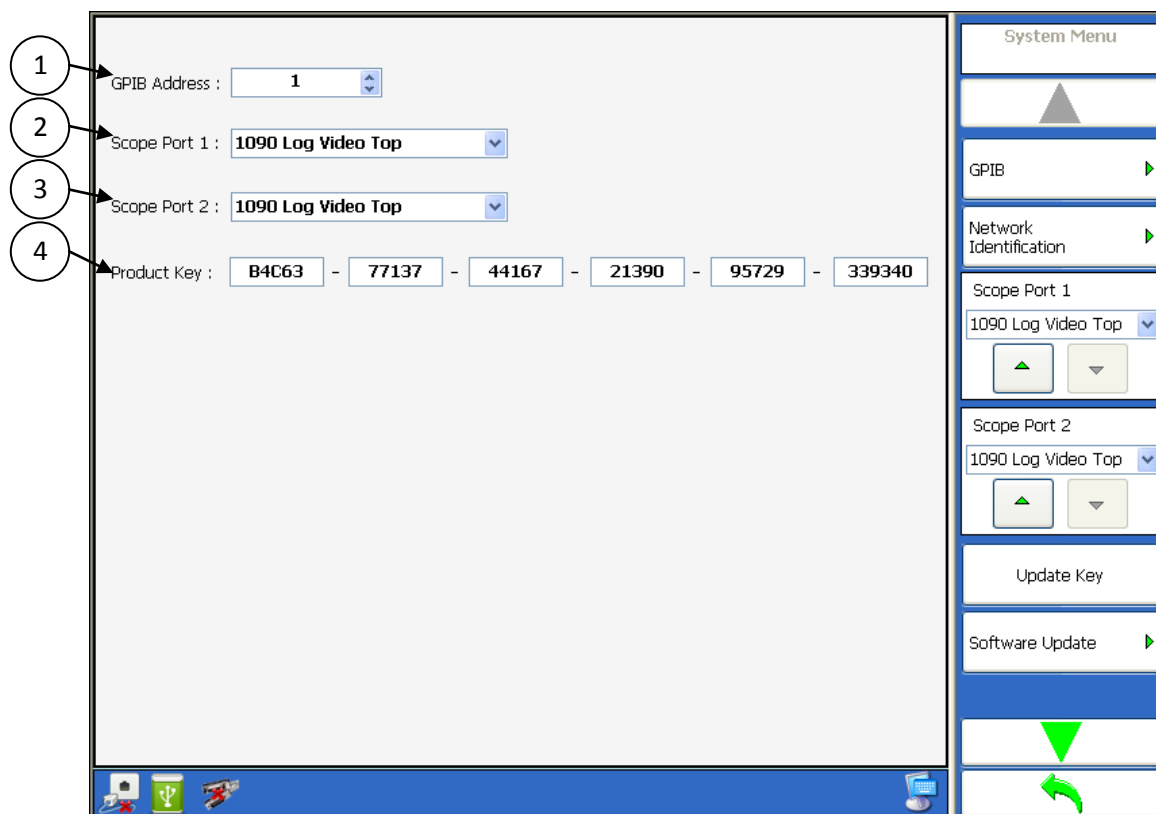

Figure 3.1.1.1 – TTG-7000 System Menu

Menu Controls	Functions
1	Current GPIB Address. GPIB address can be modified using this combo box control or GPIB softkey. GPIB address range 1 -31. Once the GPIB address is set, the TTG-7000 GPIB address on all future power up cycles will be the same. If a software update is performed then you may have to reset the GPIB address.
2	Scope Port 1. User can select from multiple test set signal lines (i.e. Log Video, DPSK Demodulation, Transmitter Modulation ...). The user can use the combo box control or softkey to select the signal. The user selection is saved and the same selection will be used on future power up cycles.
3	Scope Port 2. User can select from multiple test set signal lines (i.e. Log Video, DPSK Demodulation, Transmitter Modulation ...). The user can use the combo box control or softkey to select the signal. The user selection is saved and the same selection will

Menu Controls	Functions
	be used on future power up cycles.
4	Product Key. The product key enables/disables options in the TTG-7000 test set. ATG will provide the product key.

Softkey	Function
GPIB →	
	GPIB Address Reset
	Same as menu control item 1 Resets the GPIB Interface
Scope Port 1	Same as menu control item 2
Scope Port 2	Same as menu control item 3
Update Key	Validates the Product Key entered.
Software Update Menu	Programs DSP software and FPGA firmware.
Calibration History	Shows last calibration date and result.
BITE	Future use
Error Log	Shows any command failures via GPIB, Ethernet, or USB.
Network Identification	Shows Hostname and IP address of TTG-7000. Pressing Alt+P shows the port number.
Touch Align	Touch Screen Alignment Program
Display Settings	Display Settings

3.1.1.1. Software Update Menu

Figure 3.1.1.1.1 illustrates the TTG-7000 Software Update Menu. The Software Update Menu allows the user to update the DSP software or the FPGA firmware.

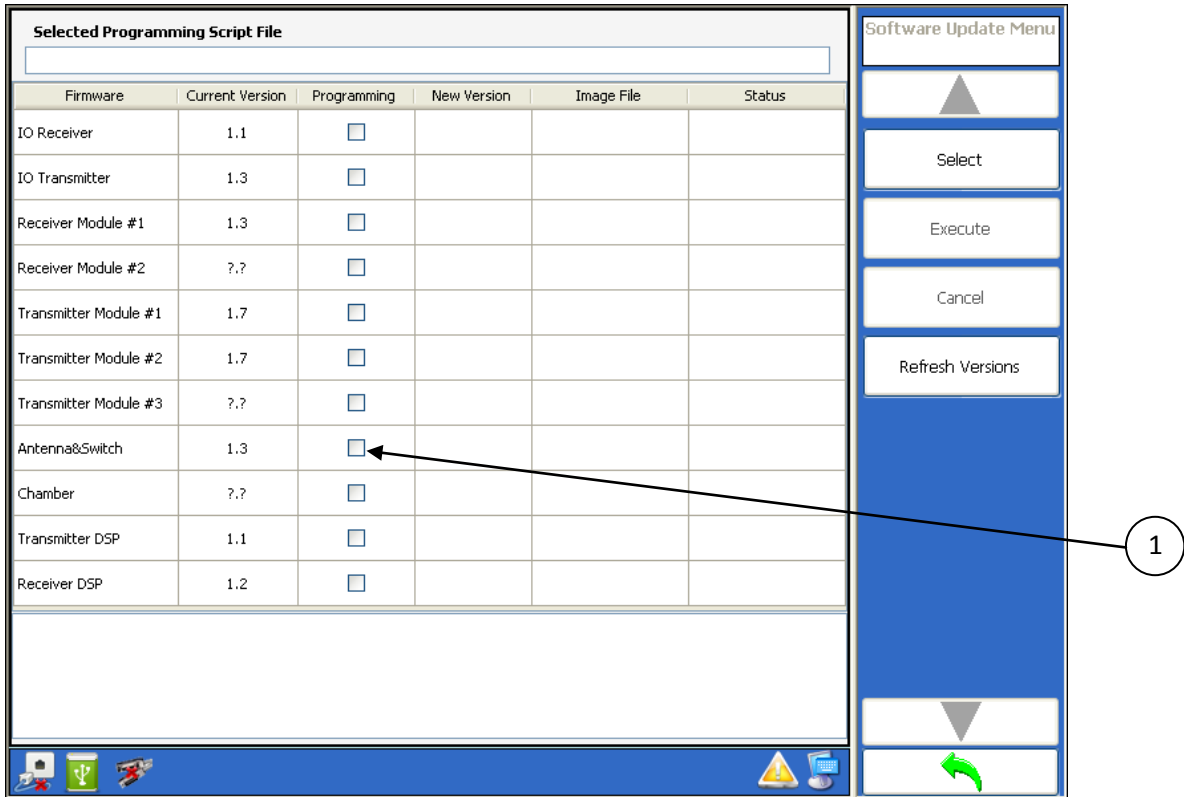

Figure 3.1.1.1.1 – TTG-7000 Software Update Menu

Menu Control	Function
1	Programming Enable Checkbox. Enables/disables the programming of a specific DSP or FPGA device.

Softkey	Function
Select	Opens a file dialog to select the programming configuration file.
Execute	Programs all the FPGAs and DSPs that are selected
Cancel	Cancels the programming sequence.
Refresh Versions	Refreshes the software and firmware versions.

Note: If you place the cursor in the “**Selected Programming Script File**” textbox on the top of the screen and press **Alt+S**, the Touchscreen software will read the last valid configuration file and displays all the valid FPGA and DSP versions.

Software Update Process:

1. Kernel and Touchscreen software are updated.
2. Kernel and Touchscreen software are executed.
3. Touchscreen software automatically starts in the Software Update Menu and programs all necessary DSP software and FPGA firmware for the updated software.
4. If step 4 is not accomplished because of an update failure. Follow the instructions on the note above to program the DSPs and FPGAs.

3.1.1.2. Network Connections Menu

Figure 3.1.1.2.1 illustrates the TTG-7000 Network Connections Menu. The Network Connections Menu illustrates the current network settings and allows changing the network settings. There should be three connections: 1) Front LAN; 2) Rear LAN; 3) DSP Connection (Names could be different). The screen will illustrate the current settings whether the IP is static or dynamic and if connected what is the current IP address. The internal connection is at IP Address 192.168.0.1 (Factory Setting). ATG recommends that if you are not required to use this address for the external connections, not to change the internal IP address. All Ethernet communications to the TTG-7000 are on port 2001.

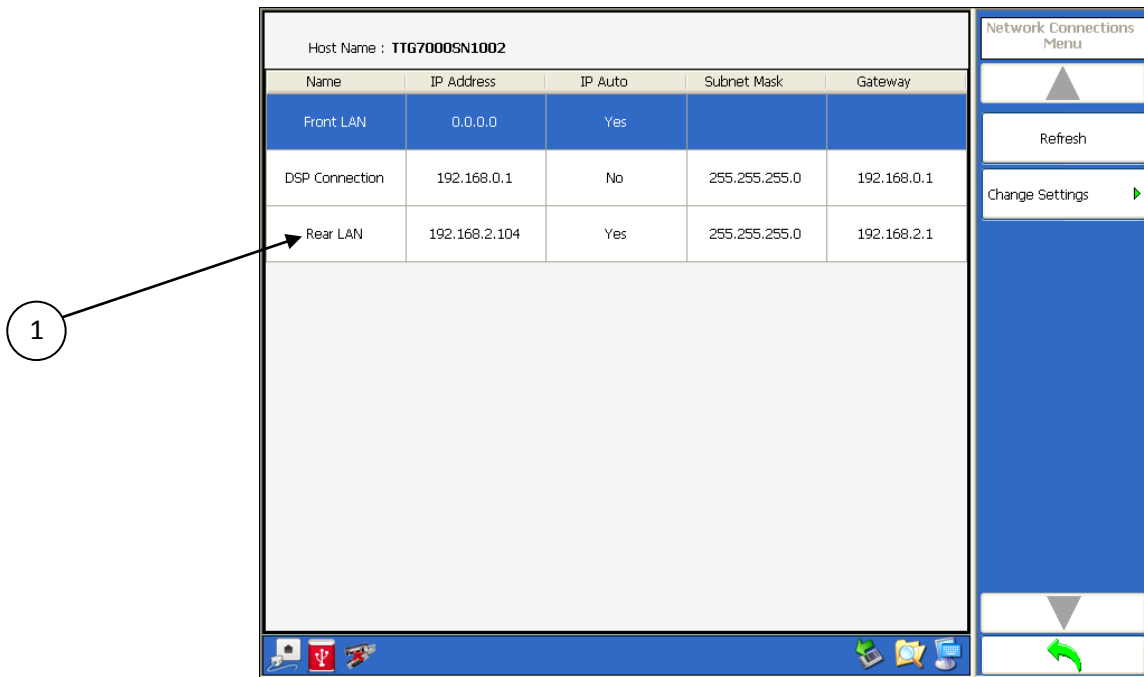

Figure 3.1.1.2.1 – TTG-7000 Network Connections Menu

Menu Control	Function
1	Shows the current setting of the network connections

Softkey	Function
Refresh	Updates the current settings
Change Settings	Illustrates the network connection change settings menu

For example, user wants to change the IP of the Rear LAN from dynamic to static. Select the Rear LAN line on the grid of the current menu and press the “**Change Settings**” Softkey.

Figure 3.1.1.2.2 illustrates the TTG-7000 Network Connections Change Settings Menu. To change the IP address to a static IP select the “**Use the following IP Address**” group box. Enter the IP address, Subnet Mask, and Gateway Address. Press the “**Set**” softkey and the IP address will be changed to a static IP. To change to a dynamic IP, select the “**Obtain an IP Address automatically**” group box and press the “**Set**” softkey.

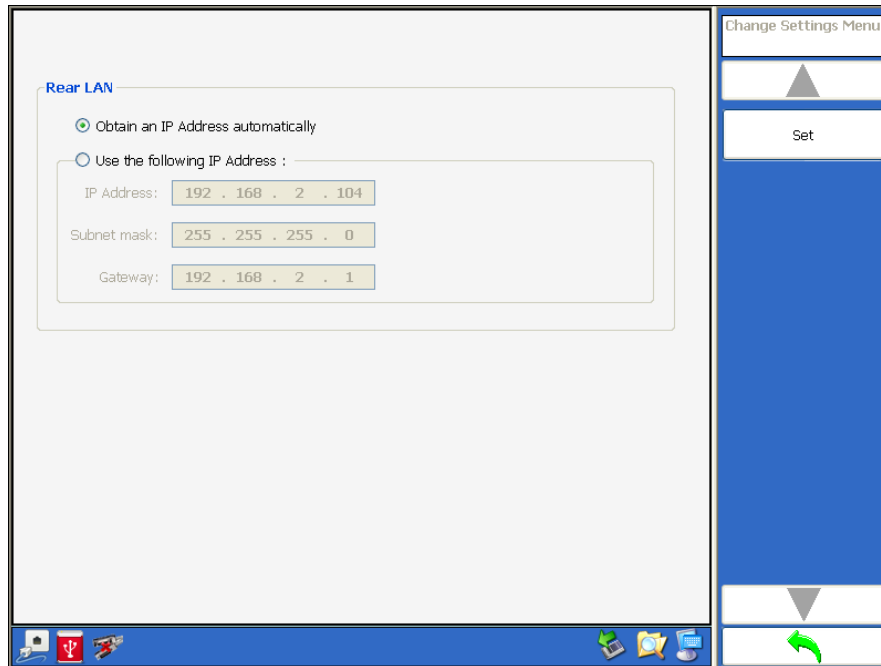

Figure 3.1.1.2.2 – TTG-7000 Network Connections Change Settings Menu

The internal DSP IP address can also be changed from the factory default of 192.168.0.1, but ATG recommends not changing it, only if the IP address is needed by the external LAN connections. On the Network Connections Menu select the DSP connection row on the grid and press the “**Change Settings**” softkey. A screen similar to Figure 3.1.1.2.3 should appear.

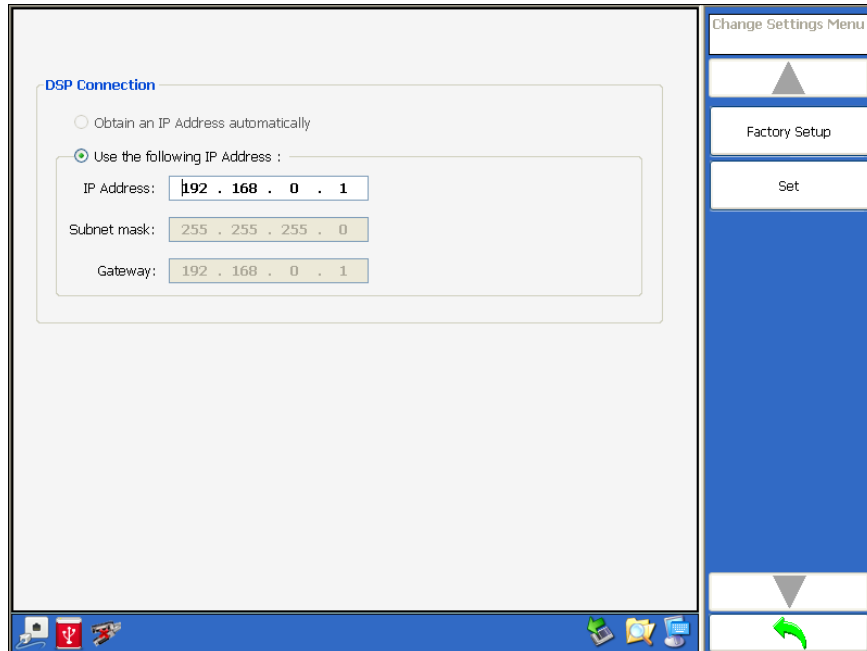

Figure 3.1.1.2.3 – TTG-7000 Internal Network Change Settings Menu

Enter the IP address desired for the internal DSP connection. The TTG-7000 will set the gateway address to the same IP Address, and will internally set the DSP IP address and will communicate the address to the DSP module when the operator presses the “**Set**” Softkey. The application software will communicate the new address to the DSP, reset the connection, and reboot the DSP. This process will take a few minutes. At the end of the process the application software will reestablish communications with the DSP using the new IP Address. On every future reboots the current IP address will be used. If the operator wants to return to the factory setup, enter the same screen and press “**Factory Setup**”. The application software will start the previously mention process with the IP address set to 192.168.0.1.

3.1.2. TCAS Main Menu

Figure 3.1.2.1 illustrates the TTG-7000 TCAS Main Menu. The TCAS Main Menu allows the user to select from multiple submenus for testing of a TCAS system.

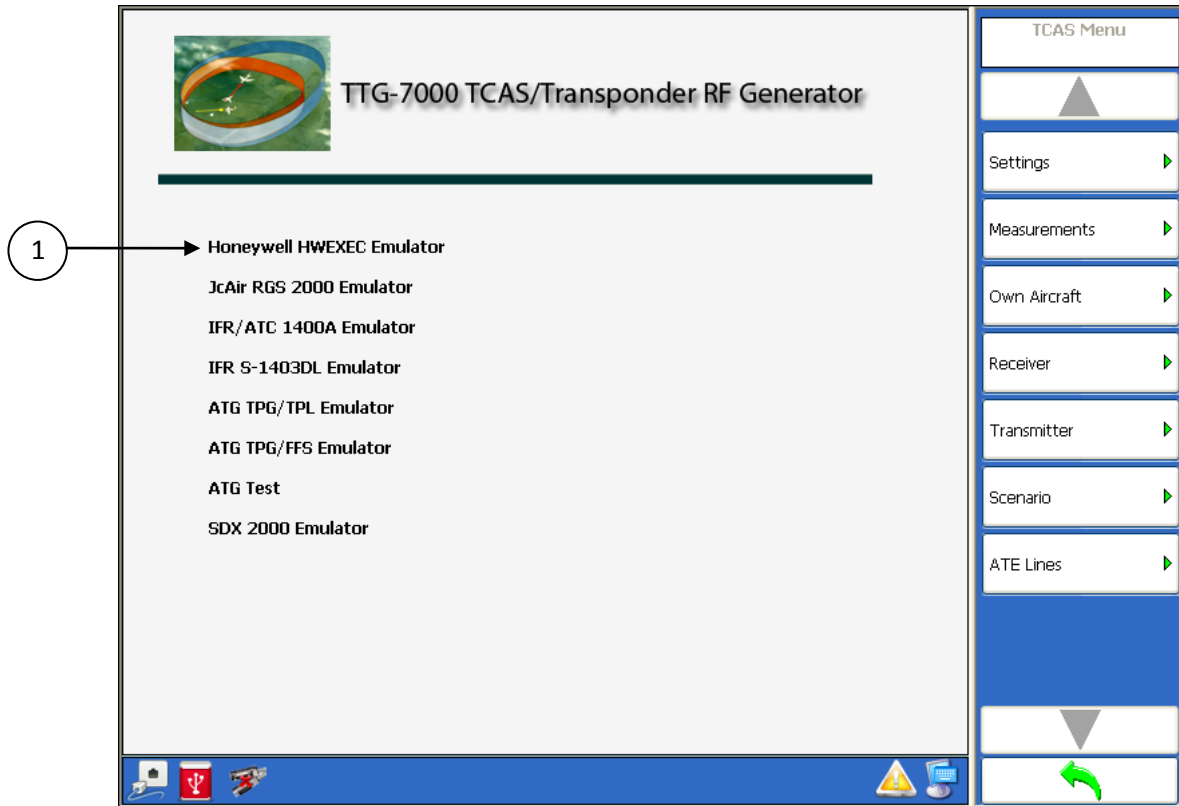

Figure 3.1.2.1 – TTG-7000 TCAS Main Menu

Menu Control	Function
1	Illustrates TCAS test options enabled for the current product key.

Softkey	Function
TCAS Setting Menu	
TCAS Measurement Menu	
Own Aircraft Menu	
TCAS Receiver Menu	
TCAS Transmitter Menu	

Softkey	Function
TCAS Scenario Menu	
ATE Lines Menu	
Chamber Mode Menu	

3.1.2.1. TCAS Settings Menu

Figure 3.1.2.1.1 illustrates the TTG-7000 TCAS Settings Menu. The TCAS Settings Menu allows the user to configure the Transmitter, Receiver, and Antenna Simulator modules within the test set. This menu is mainly used for testing and troubleshooting of the TTG-7000. For TCAS unit testing, this menu should only be used to set the individual RF generator frequencies.

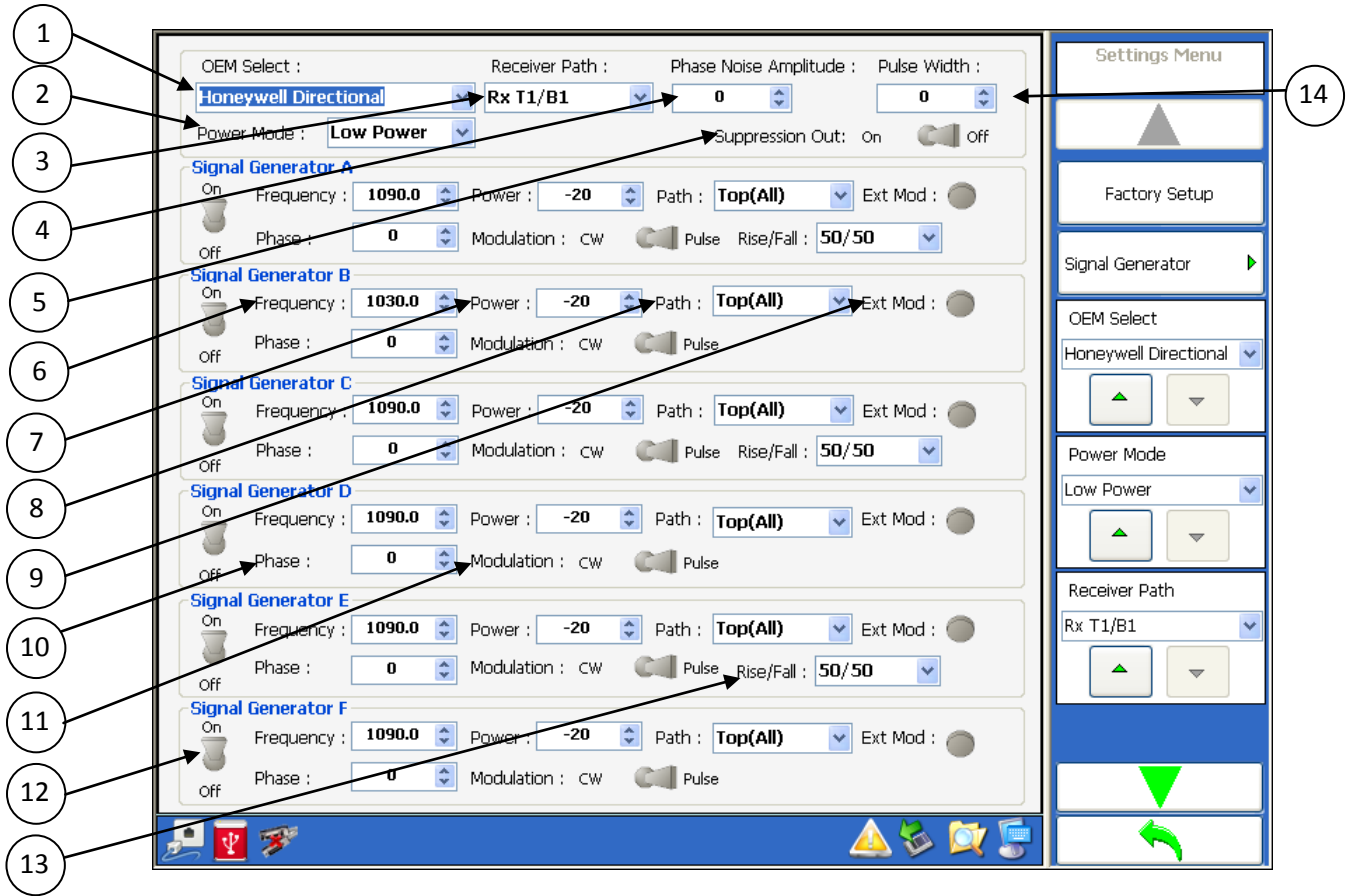

Figure 3.1.2.1.1 – TTG-7000 TCAS Settings Menu

Menu Control	Function
1	OEM Select Combobox allows the user to select the TCAS system OEM. The antenna resistors are set according to OEM selection. Also the calibration tables to emulate the bearing of intruders are loaded according to the OEM selection. OEM selections are Honeywell Directional, Honeywell Omni, Collins Phase Directional, Collins Phase Omni, ACSS Directional, ACSS Omni, Collins Magnitude Directional, Collins Magnitude Omni, Garmin or Avidyne.

Menu Control	Function
2	Power Mode Combobox allows the user to select between high or low power modes. Low power allows setting the output power from -20 to -90 dBm. High power allows setting the power from 1 to -69 dBm.
3	Receiver Path Combobox allows the user to select which port to connect the Top/Bottom Receiver. Selections available are Rx T1/B1, Rx T2/B2, Rx T3/B3, Rx T4/B4, Chamber, or Combiner. Note : On Collins Magnitude or ACSS this setting is automatically switched to Combiner.
4	Phase Noise Amplitude. Future use.
5	Suppression Out On/Off. Future use.
6	Tx Frequency Numeric Box allows the setting of the Transmitter frequency. Individual setting for each transmitter. Range from 962 to 1213 MHz in 0.1 MHz steps.
7	Tx Power Numeric Box allows the setting of the Transmitter power from -20 to -90 dBm in 1 dB steps in low power mode or from 1 to -69 dBm in 1 dB steps in high power mode.
8	Tx Path allows setting the Tx path to Top All Ports/Bottom All Ports/Single Port. Selections are T1, T2, T3, T4, Top (All), B1, B2, B3, B4, and Bottom (All).
9	External Modulation On/Off. Future use.
10	Phase (Bearing) for the specific Transmitter. Range 0 to 359 degrees in 1-degree steps.
11	Modulation CW/Pulse
12	Signal Generator On/Off
13	Pulse Risetime/Falltime slow or normal.
14	Pulsewidth Combobox allows the user to adjust the pulsewidth of all the transmissions by +/- 100 nanoseconds in 25 nanosecond steps.

Softkey		Function
Factory Setup		Sets all hardware to default setting according to hardware configuration.
Signal Generator Menu→	Generator A→ On/Off Frequency Modulation Path Power Phase Rise/Fall Ext. Mod Generator B On/Off Frequency Modulation Path Power	Same as menu control item 12. Same as menu control item 6. Same as menu control item 11. Same as menu control item 8. Same as menu control item 7. Same as menu control item 10. Same as menu control item 13. Same as menu control item 9. Same as menu control item 12. Same as menu control item 6. Same as menu control item 11. Same as menu control item 8. Same as menu control item 7.

Softkey		Function
	Phase Ext. Mod Generator C Generator D Generator E Generator F	Same as menu control item 10. Same as menu control item 9. Same as Generator A. Same as Generator B. Same as Generator A. Same as Generator B.
OEM Select		Same as menu control item 1.
Power Mode		Same as menu control item 2.
Receiver Path		Same as menu control item 3.
Suppression Out		Future use.
Phase Noise		Future use.
Pulsewidth		Same as menu control item 14.

Note: Selection of OEM changes the Antenna Simulation module, the antenna resistors, and loads the calibration tables for bearing for the selected OEM.

3.1.2.2. TCAS Own Aircraft Menu

Figure 3.1.2.2.1 illustrates the TTG-7000 Own Aircraft Menu. The TCAS Own Aircraft Menu allows the user to change the latitude, longitude, altitude, heading, and Mode S address of the own aircraft (TCAS under test).

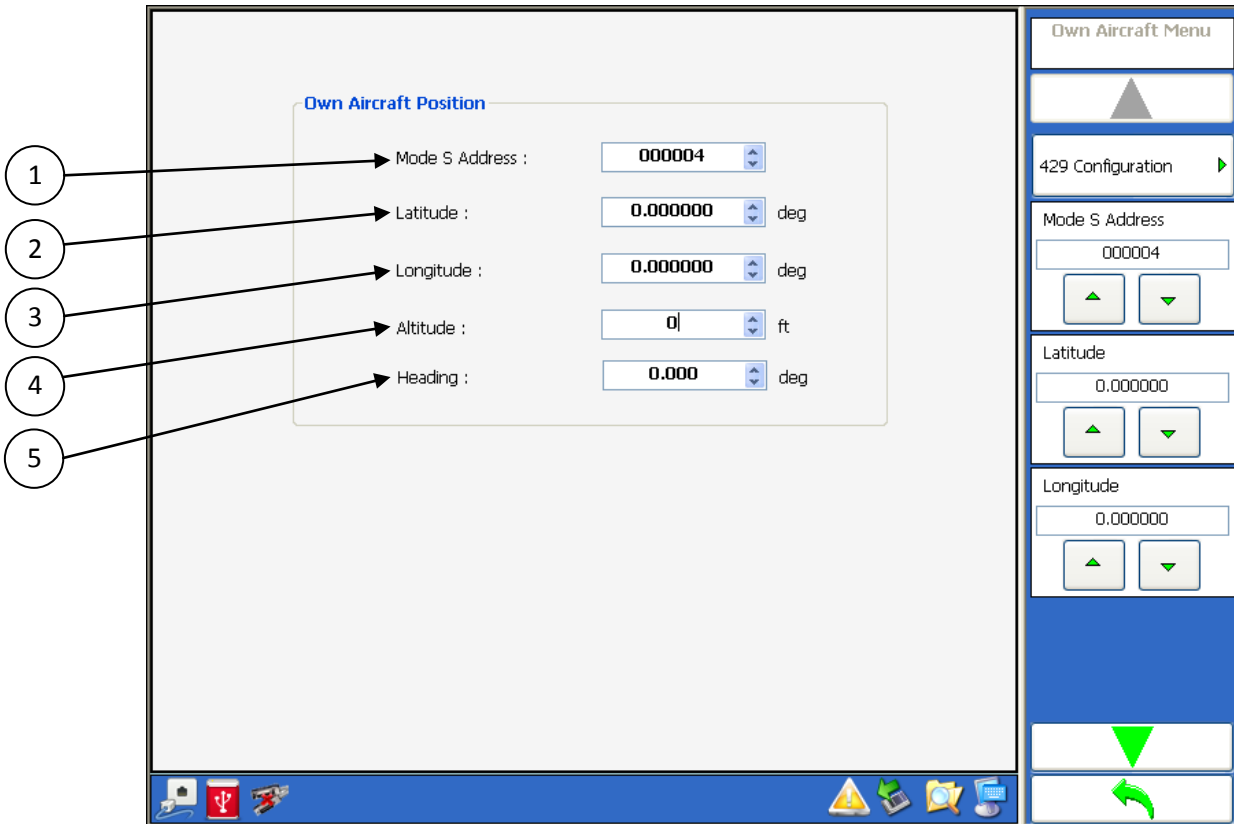

Figure 3.1.2.2.1 – TTG-7000 TCAS Own Aircraft Menu

Menu Control	Function
1	Mode S Address numeric box. (24 bits). Hexadecimal
2	Latitude numeric box allows the user to enter the latitude of the own aircraft. Range from -90 to 90 degrees.
3	Longitude numeric allows the user to enter the longitude of the own aircraft. Range from -180 to 180 degrees.
4	Altitude numeric box allows the user to enter the altitude of the own aircraft in feet. Range from -1000 to 64535 feet.

Menu Control	Function
5	Heading numeric box allows the user to enter the heading of the own aircraft in degrees. Range from -180 to 180 degrees.

Softkey	Function
Latitude	Same as menu control item 2.
Longitude	Same as menu control item 3.
Altitude	Same as menu control item 4.
Heading	Same as menu control item 5.
Mode S Address	Same as menu control item 1.
429 Configuration →	Illustrates the 429 Configuration Menu

Note: When an external source (Ethernet or 429) is used the own aircraft information is updated every 5 seconds when a Scenario is not running. The data is updated every second if the scenario is running.

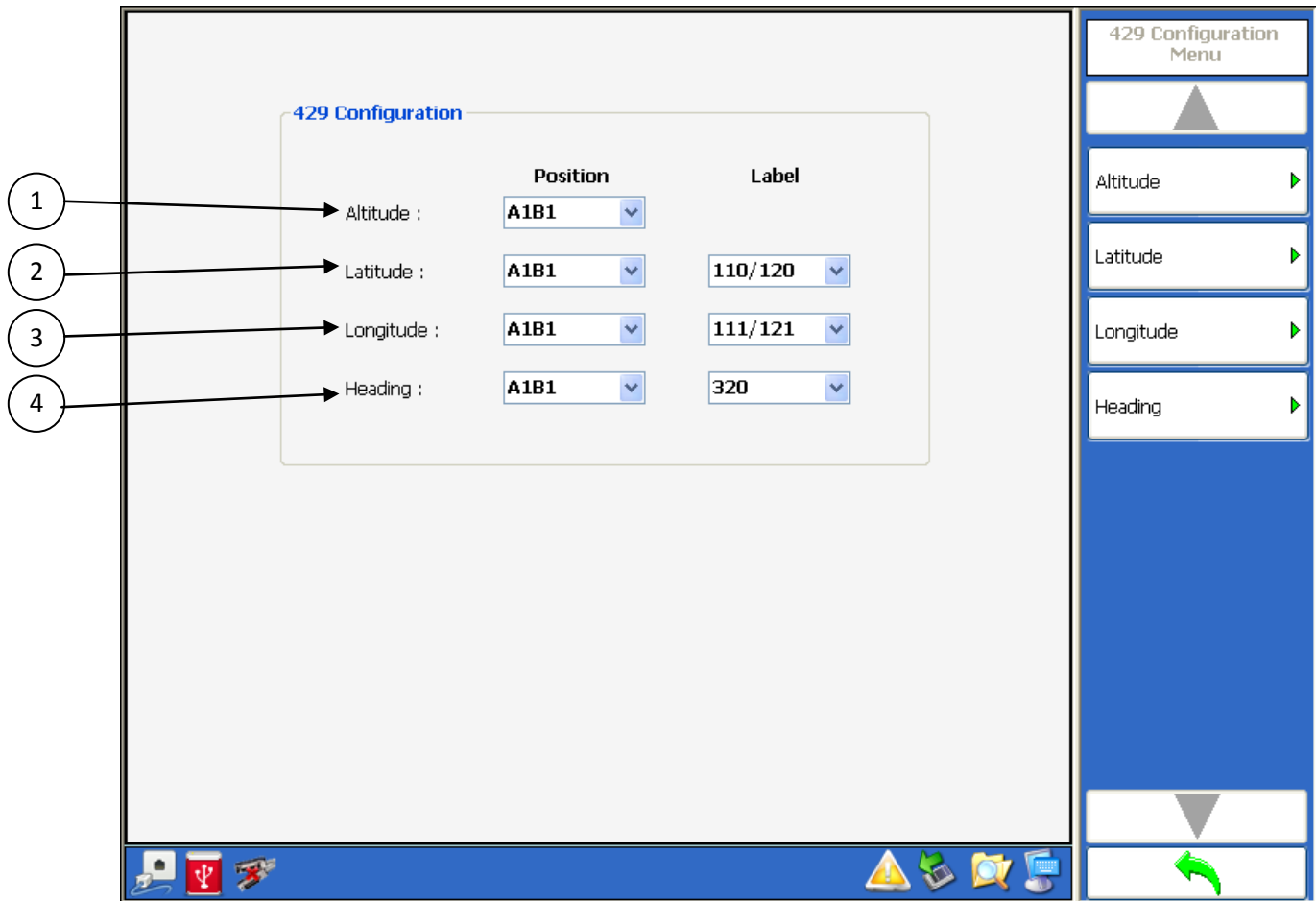

Figure 3.1.2.2.2 – TTG-7000 TCAS Own Aircraft 429 Configuration Menu

Menu Control	Function
1	Altitude 429 Position. Allows the user to select the input port of the 429 adapter for the altitude data. Selection is maintained on future power up cycles.
2	Latitude 429 Position and label configuration. Allows the user to select the input port of the 429 adapter for the latitude data and also the 429 label to use. Selections are maintained on future power up cycles.
3	Longitude 429 Position and label configuration. Allows the user to select the input port of the 429 adapter for the longitude data and also the 429 label to use. Selections are maintained on future power up cycles.
4	Heading 429 Position and label configuration. Allows the user to select the input port of the 429 adapter for the heading data and also the 429 label to use. Selections are maintained on future power up cycles.

Softkey	Function
Latitude	Same as menu control item 2.
Longitude	Same as menu control item 3.

Softkey	Function
Altitude	Same as menu control item 1.
Heading	Same as menu control item 4.

3.1.2.3. TCAS Receiver Menu

Figure 3.1.2.3.1 illustrates the TTG-7000 TCAS Receiver Menu. The TCAS Receiver Menu allows the user to view the transmissions from the TCAS system and the transmissions from the TTG-7000 test set.



Figure 3.1.2.3.1 – TTG-7000 TCAS Receiver Menu

Menu Control	Function
1	Top section of the Receiver Menu illustrates the status of reception from either the TCAS system under test or from the test set. There is a LED associated for the ATCRBS Reply, DF Reply, ATCRBS Interrogation, and UF Interrogation for the TCAS System (Rx Group) and the test set (Tx Group). For UAT option, LEDs are shown in the Rx and Tx group.
2	Reception section shows the last 8 receptions. Lines in blue represent receptions from the TCAS system. Lines in green represent receptions from the test set.

Softkey	Function
Capture→	
UUT DF	Enable/disable capture of Transponder DF messages.
TTG DF	Enable/disable capture of test set DF messages.
UUT UF	Enable/disable capture of TCAS UF messages.
TTG UF	Enable/disable capture of test set UF messages.
UUT ATCRBS Replies	Enable/disable capture of Transponder ATCRBS replies.
TTG ATCRBS Replies	Enable/disable capture of test set ATCRBS replies.
UUT ATCRBS Interrogation	Enable/disable capture of TCAS ATCRBS interrogations.
TTG ATCRBS Interrogation	Enable/disable capture of test set ATCRBS interrogations.
UUT UAT	Enable/disable capture of UAT messages (Optional).
TTG UAT	Enable/disable capture of UAT messages (Optional).
Display→	
Display	Allows turning on/off displaying new receptions.
Mode	
Update	Display data received by updating a message style with the latest reception.
Continuous	Display all data received in a continuous order by time.
Time	
Relative	Display time relative to previous message.
Absolute	Display the time received.
Clear	Clears all messages in the receiver menu.
Quantity to Show	Allows entering how many messages to show. (Maximum 1000 messages)
Refresh	Refreshes the receiver menu with the selected quantity of messages.
Frame Details	Illustrates the detail breakdown of a selected reception. See Figure 3.1.2.3.2. The detail breakdown of message can also be displayed, by turning off the Display softkey and double clicking on the desired message.
Data Logging→	
Record/Stop	Allows start and stopping data logging receive messages.
Export	Allows exporting receive messages to file.

Softkey	Function
Clear	Clears all recorded messages.
Filtered Masked Menu	
Highlight Masked Menu	

When performing an export the TTG-7000 generates a SDF (Compact Database File) and exports the file to the selected file location. The operator can download from ATG’s website a Reporting Tool that will display the contents of the SDF file and will allow the user to generate multiple CSV files from the exported data. Also all the DF17 position, velocity, and identification messages are decoded in the Reporting Tool.

Name	Value	Units	LSB	Notes	Low	High
UF	0	N/A	0	Uplink Format Field	0	0
Spare	0	N/A	0		0	0
Reply Length	0	N/A	0	0 Reply DF=0 , 1 Reply DF=16	0	1
Spare	0	N/A	0		0	0
Acquisition Special	0	N/A	0		0	1
BD	0	N/A	0		0	30
Spare	0	N/A	0		0	0
AP	0003FF	N/A	0		000000	000000

Rx Frame Details Menu

UF

0

▲ ▼

Spare

0

▲ ▼

Reply Length

0

▲ ▼

▼

↶

Figure 3.1.2.3.2 – TTG-7000 TCAS Receiver Frame Detail Menu

3.1.2.3.1. TCAS Receiver Filtered Masked Menu

Figure 3.1.2.3.1.1 illustrates the TTG-7000 TCAS Receiver Filtered Masked Menu. The TCAS Receiver Filtered Masked Menu allows the user to select what messages to filter and display in the Receiver menu.

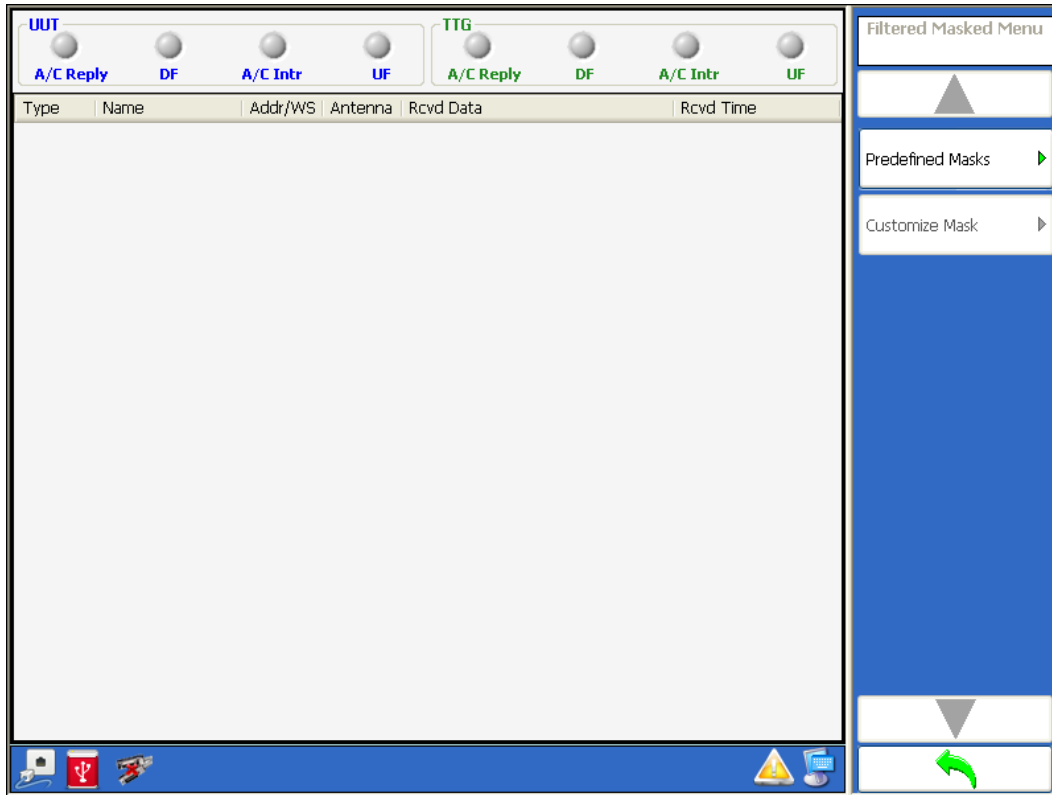

Figure 3.1.2.3.1.1 – TTG-7000 TCAS Receiver Filtered Masked Menu

Softkey	Function
Predefined Mask	Allows selection of predefined masks.
Customize Mask	Allows user to customize mask and pattern.

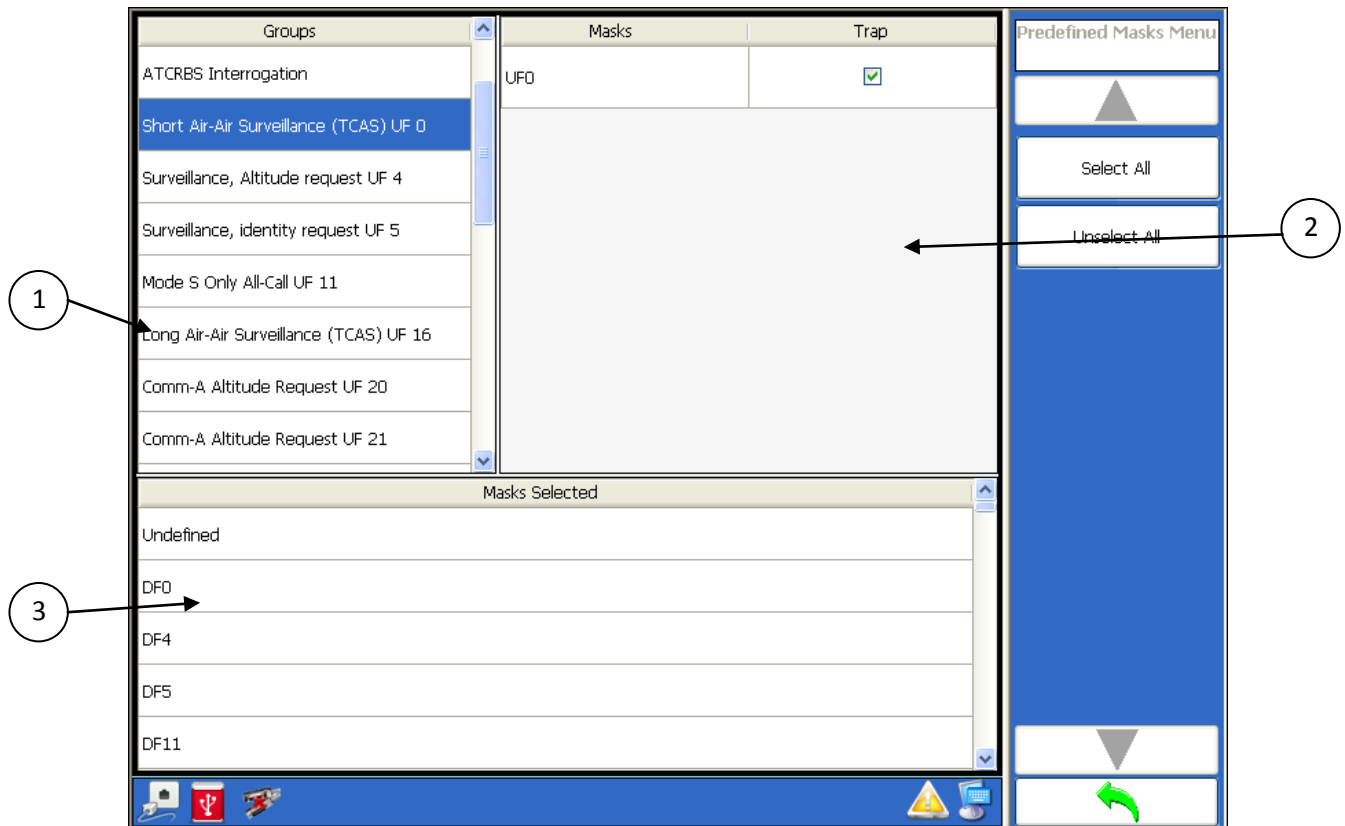

Figure 3.1.2.3.1.2 - Predefined Mask Filter

Menu Control	Function
1	Groups of UF and DF messages.
2	Sub messages in selected group.
3	Messages selected to perform filter.

Softkey	Function
Select All	Selects all messages to display. No filter is applied.
Unselect All	Unselects all messages, therefore no message is displayed.

Note: Individual messages are selected using the checkboxes in menu control section 2 of Figure 3.1.2.3.1.2.

3.1.2.3.2. TCAS Receiver Highlight Masked Menu

Figure 3.1.2.3.2.1 illustrates the TTG-7000 TCAS Receiver Highlight Masked Menu. The TCAS Receiver Highlight Masked Menu allows the user to select what messages to highlight during display of messages in the Receiver menu.

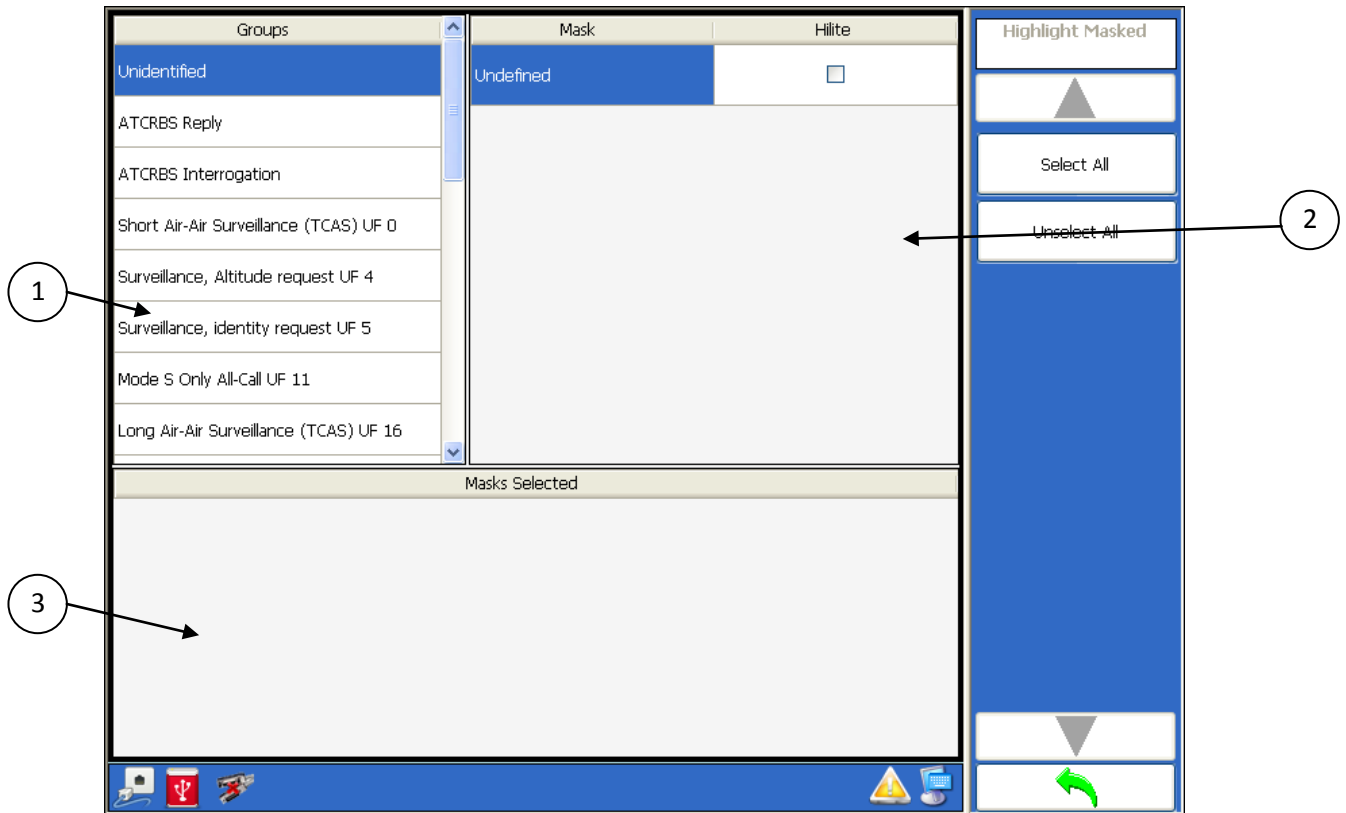

Figure 3.1.2.3.2.1 – TTG-7000 TCAS Receiver Highlight Masked Menu

Menu Control	Function
1	Groups of UF and DF messages.
2	Sub messages in selected group.
3	Messages selected to perform highlight.

Softkey	Function
Select All	Selects all messages to highlight.
Unselect All	Unselects all messages, therefore no message is highlighted.

Note: To enable highlighting of individual messages check the appropriate checkboxes in menu control section 2 of Figure 3.1.2.3.2.1.

3.1.2.4. TCAS Transmitter Menu

Figure 3.1.2.4.1 illustrates the TTG-7000 TCAS Transmitter Menu. The TCAS Transmitter Menu allows the user to implement a block of transmissions or RTCA DO-260 tests.

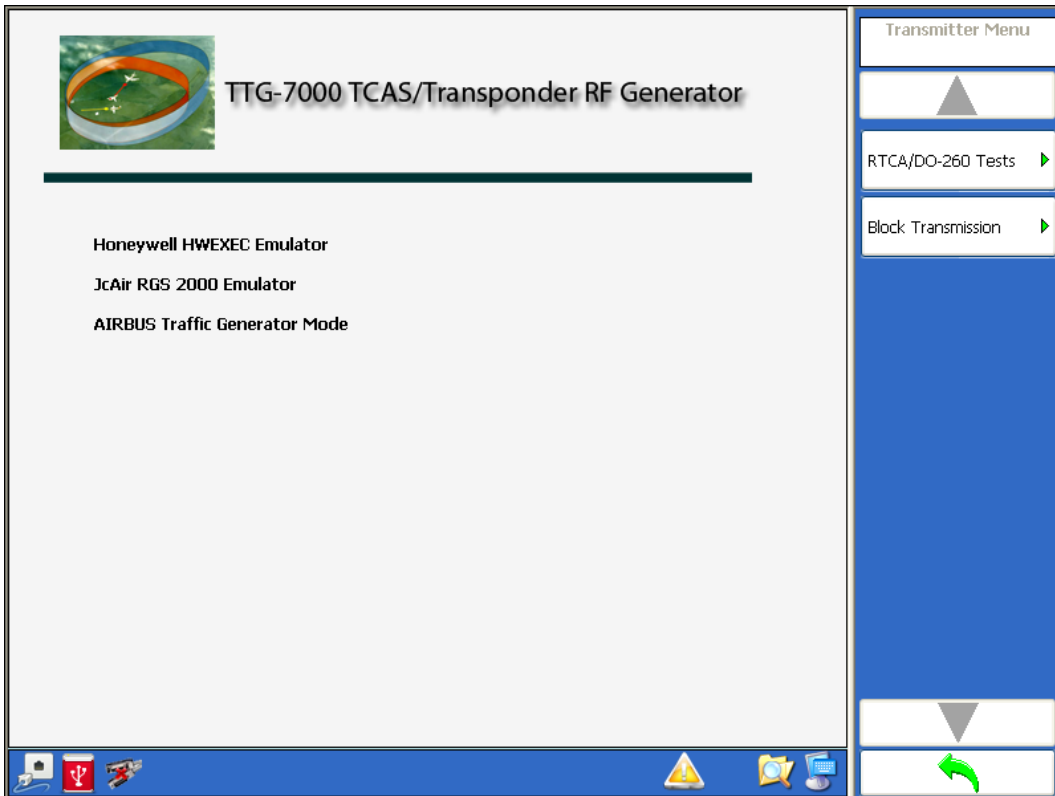

Figure 3.1.2.4.1 – TTG-7000 TCAS Transmitter Menu

Softkey	Function
RTCA/DO-260 Tests	Displays a menu that allows the user to set the TTG-7000 generators to perform RTCA DO-260 tests.
Block Transmissions	Displays a menu that allows the user to set a group of messages (UF, DF, ATRCBS Interrogation, and ATRCBS Replies) to transmit at a specific time and block period.

3.1.2.4.1. RTCA/DO-260 Tests

Figure 3.1.2.4.1.1 illustrates the TTG-7000 RTCA/DO-260 Tests Menu. The TTG-7000 RTCA/DO-260 Tests Menu allows the user to define tests that set the TTG-7000 transmitters for RTCA DO-260 receiver testing.

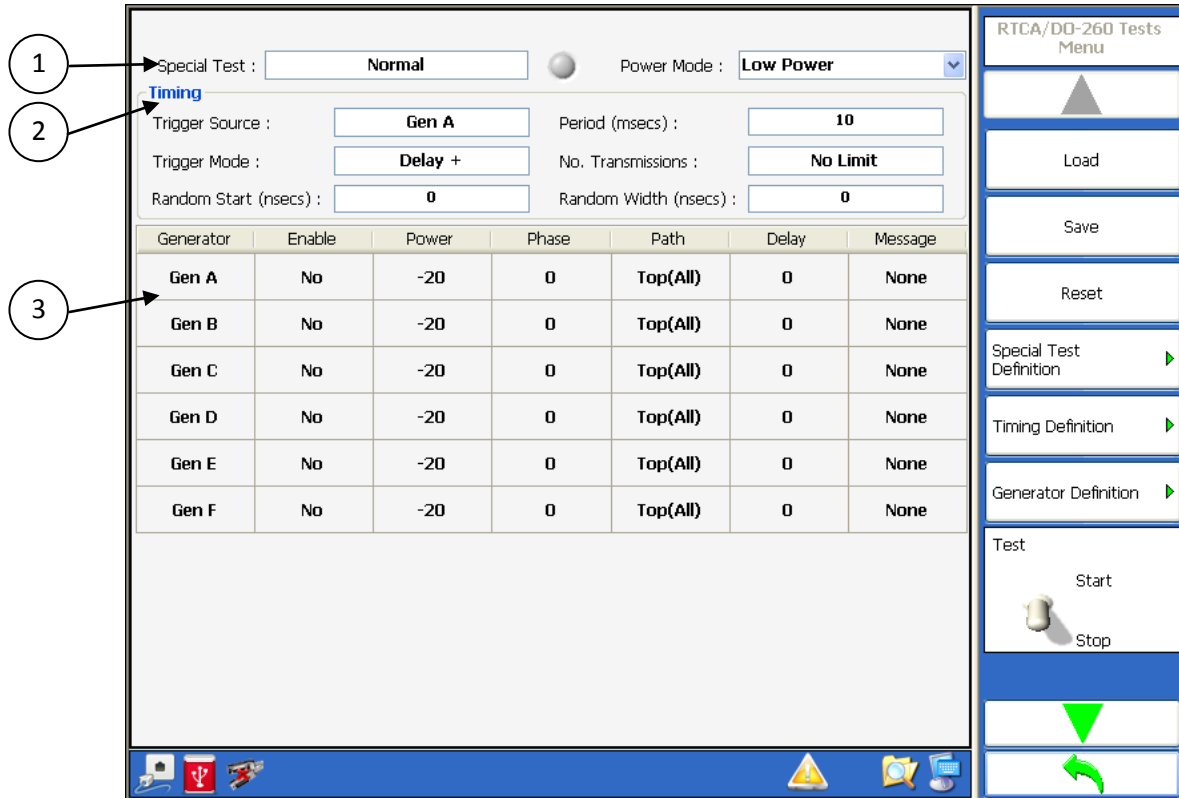

Figure 3.1.2.4.1.1 – RTCA/DO-260 Tests Menu

Menu Control	Function
1	This section displays special test selected.
2	This section illustrates timing settings.
3	This section illustrates generator settings.

Softkey	Function
Load	Allows loading a stored DO-260 test. Most RTCA DO-260 tests have been predefined and can be loaded using this softkey.
Save	Allows saving the current DO-260 test.
Reset	Resets the test settings to the default.

Softkey	Function
Special Test Definition	Opens a new menu that allows setting one of the special tests (Normal, Altered Preamble, Bit Failures, Overlapping Pulse). Figure 3.1.2.4.1.2 shows the normal test setting. Figure 3.1.2.4.1.3 shows the altered preamble setting. Figure 3.1.2.4.1.5 shows the bit failures setting. Figure 3.1.2.4.1.6 shows the overlapping pulse setting.
Timing Definition	Opens a new menu that allows setting the timing definitions.
Generator Definition	Opens a new menu that allows setting the generator definitions.
Test Start/Stop	Allows the user to start or stop the defined DO-260 tests.
Power Mode	Allows low power (-20 to -90 dBm) or high power (+1 to -69 dBm) operation

Figure 3.1.2.4.1.2 illustrates the RTCA/DO-260 Special Test Normal Definition Menu. The normal selection does not allow altering any parameters.

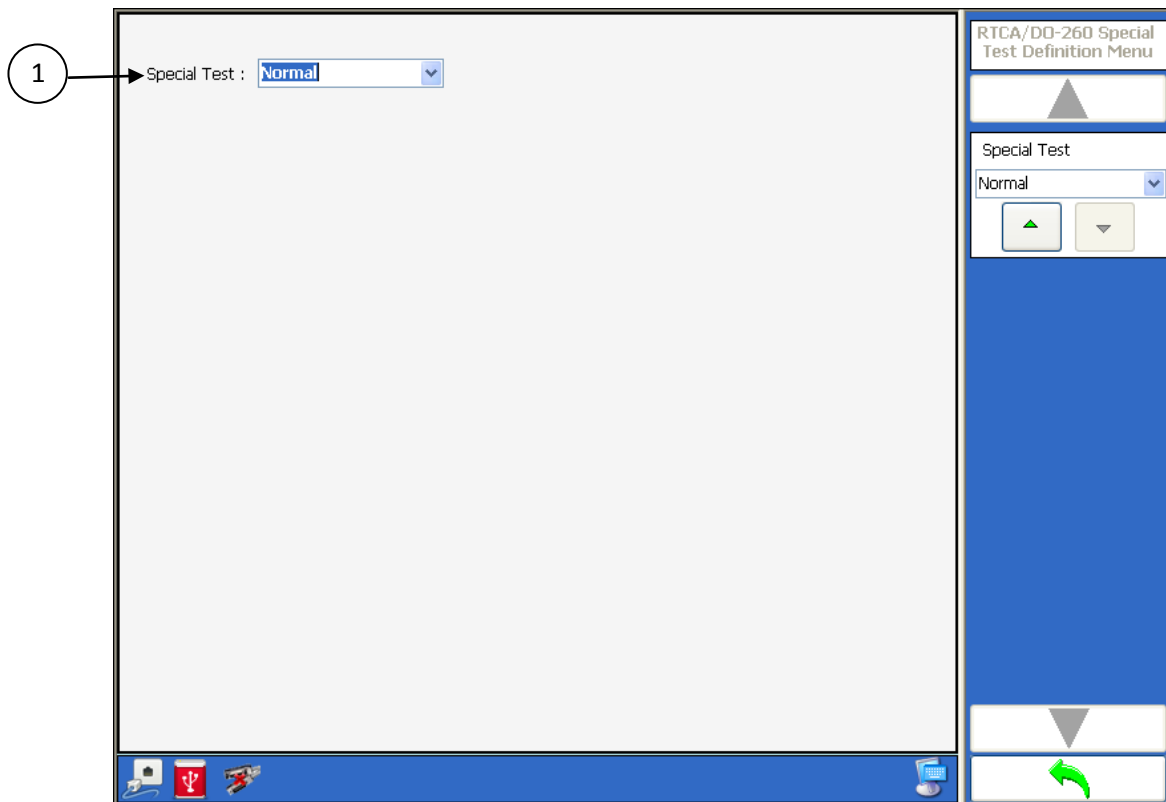

Figure 3.1.2.4.1.2 – RTCA/DO-260 Special Test Definition Normal Menu

Menu Control	Function
1	Special Test combobox allows setting type of special test (Normal, Altered Preamble, Bit Failures, Overlapping Pulse)

Softkey	Function
Special Test	Same as menu control item 1.

Figure 3.1.2.4.1.3 illustrates the RTCA/DO-260 Special Test Altered Preamble Definition Menu. This menu allows the operator to change the preamble pulses of the Mode S message. The width, position, power and visibility of each of the preamble pulses can be changed. Transmissions are sent simultaneously on the top and bottom antennas.

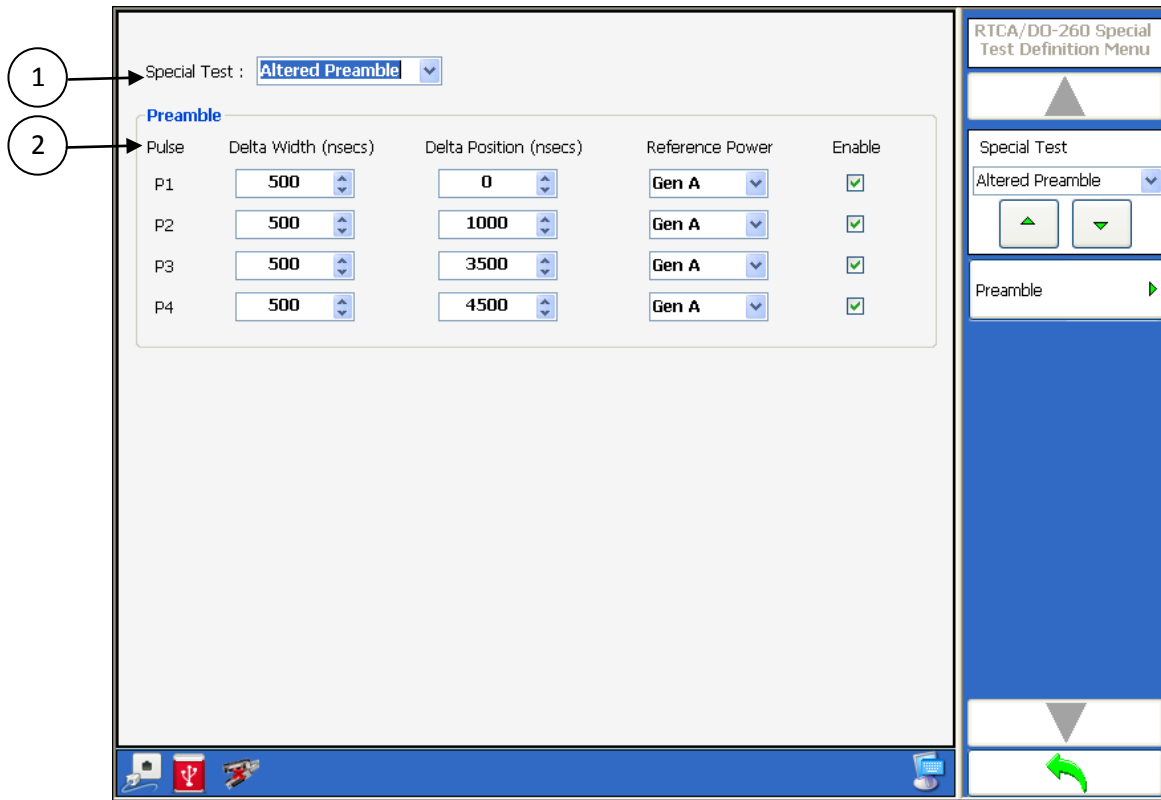

Figure 3.1.2.4.1.3 – RTCA/DO-260 Special Test Definition Altered Preamble Menu

Menu Control	Function
1	Special Test combobox allows setting type of special test (Normal, Altered Preamble, Bit Failures, Overlapping Pulse)
2	Preamble section allows alteration of Mode S preamble (Width, Position, Reference Power, and Enable).

Softkey	Function
Special Test	Same as menu control item 1.
Preamble →	Same as menu control item 2. Displays the softkeys to change the Mode S preamble parameters.
Reset	

Softkey	Function
Pulse 1 →	Width Position Power Enable
Pulse 2 →	Width Position Power Enable
Pulse 3 →	Width Position Power Enable
Pulse 4 →	Width Position Power Enable

Figure 3.1.2.4.1.4 illustrates the TTG-7000 RTCA/DO-260 Tests Menu after altered preamble is selected for the special test. The screen illustrates the timing parameters, the generators that are being used, and in the case of altered preamble the preamble settings on the bottom of the screen.

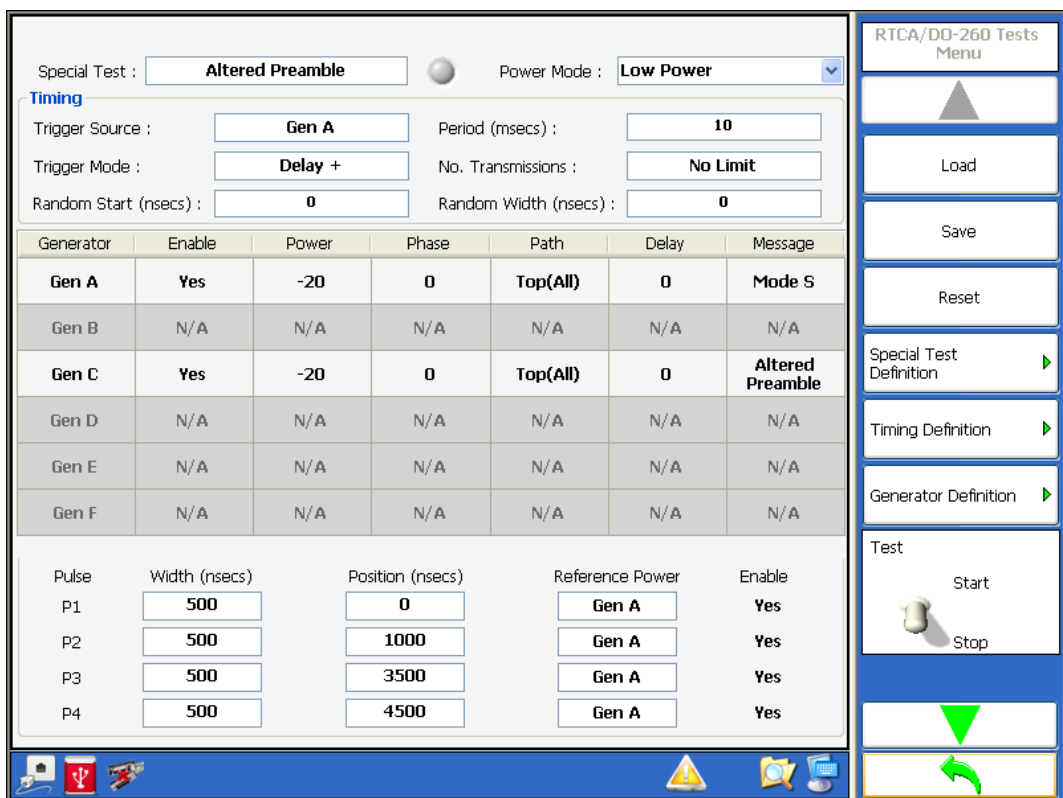

Figure 3.1.2.4.1.4 – RTCA/DO-260 Tests Menu (Altered Preamble)

Note: In the Altered Preamble mode the message defined is transmitted on the top and bottom antenna simultaneously.

Figure 3.1.2.4.1.5 illustrates the RTCA/DO-260 Special Test Bit Failures Definition Menu. This menu allows the operator to specify the start chip and the ending chip for energy on both sides of the manchester code, and also allows selections of bad bits (inverted after PI Calculation).

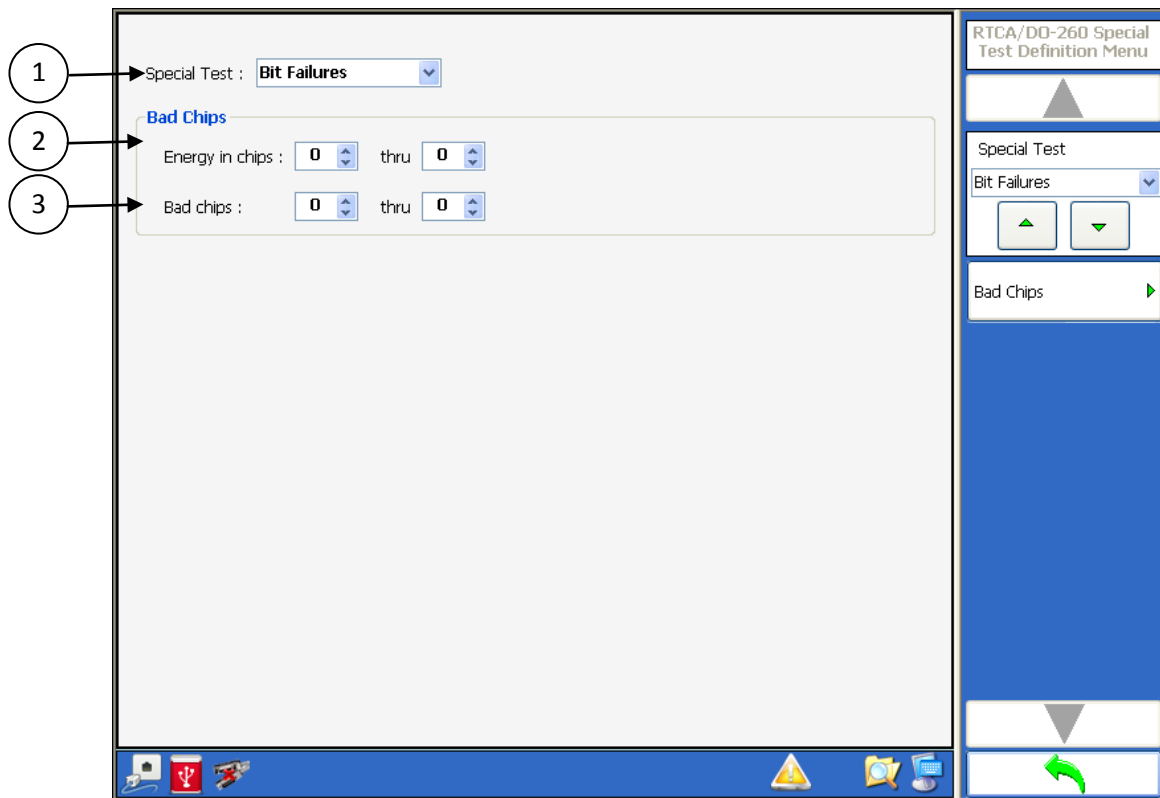

Figure 3.1.2.4.1.5 – RTCA/DO-260 Special Test Definition Bit Failures Menu

Menu Control	Function
1	Special Test combobox allows setting type of special test (Normal, Altered Preamble, Bit Failures, Overlapping Pulse)
2	Energy in Chips section allows setting the start and ending chip with energy on both parts of the bit.
3	Bad Chips selects the bits that will be inverted after the calculation of the PI Field

Softkey	Function
Special Test	Same as menu control item 1.
Bad Chips →	Same as menu control item 2. Displays the softkeys to change the bad chip parameters.
Energy Chips First Bit	
Energy Chips Last Bit	
Bad Chips First Bit	
Bad Chips Last Bit	

Note: In the Special Test Bit Failures mode the message defined is transmitted on the top and bottom antenna simultaneously.

Figure 3.1.2.4.1.6 illustrates the RTCA/DO-260 Special Test Overlapping Pulse Definition Menu. This menu allows the operator to specify the delay from P1 and pulse width of the overlapping pulse.

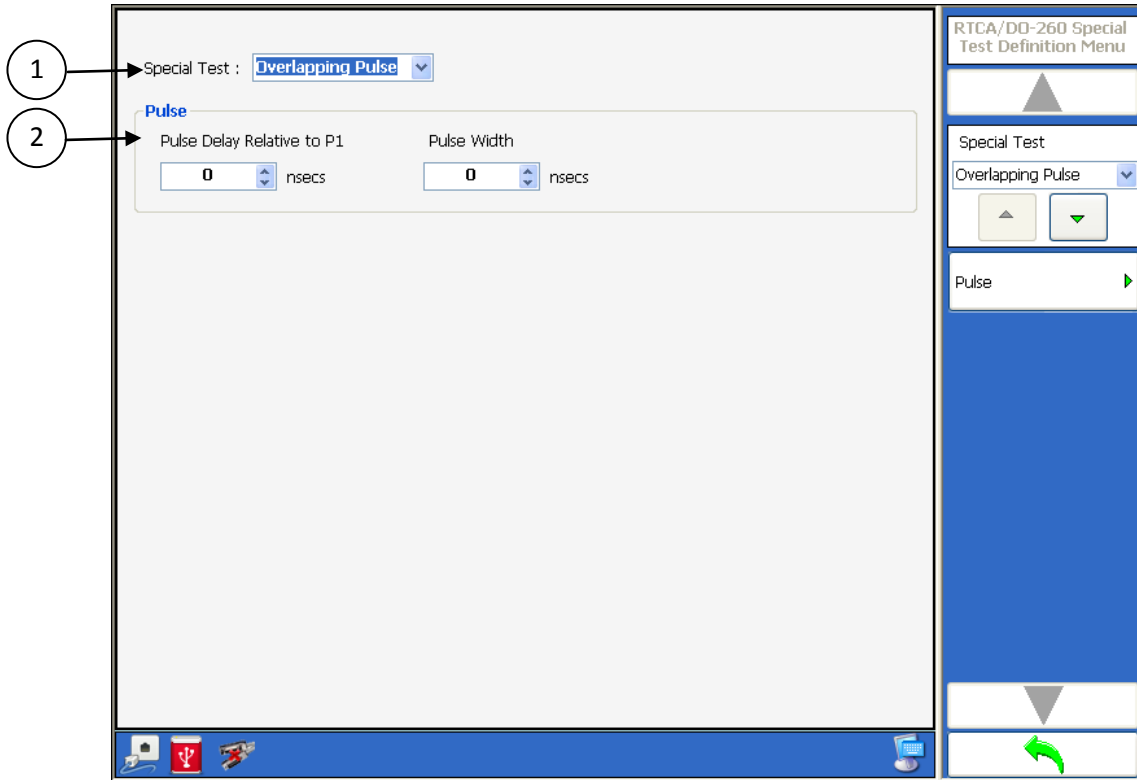

Figure 3.1.2.4.1.6 – RTCA/DO-260 Special Test Definition Overlapping Pulse Menu

Menu Control	Function
1	Special Test combobox allows setting type of special test (Normal, Altered Preamble, Bit Failures, Overlapping Pulse)
2	Pulse section allows setting the starting position and width of the overlapping pulse.

Softkey	Function
Special Test	Same as menu control item 1.
Bad Chips →	Same as menu control item 2. Displays the softkeys to change the overlapping pulse parameters.
Width	
Delay	

Note: In the Overlapping Pulse mode the message defined is transmitted on the top and bottom antenna simultaneously.

Figure 3.1.2.4.1.7 illustrates the RTCA/DO-260 Timing Definition Menu. This menu allows the operator to specify the timing parameters for the test.

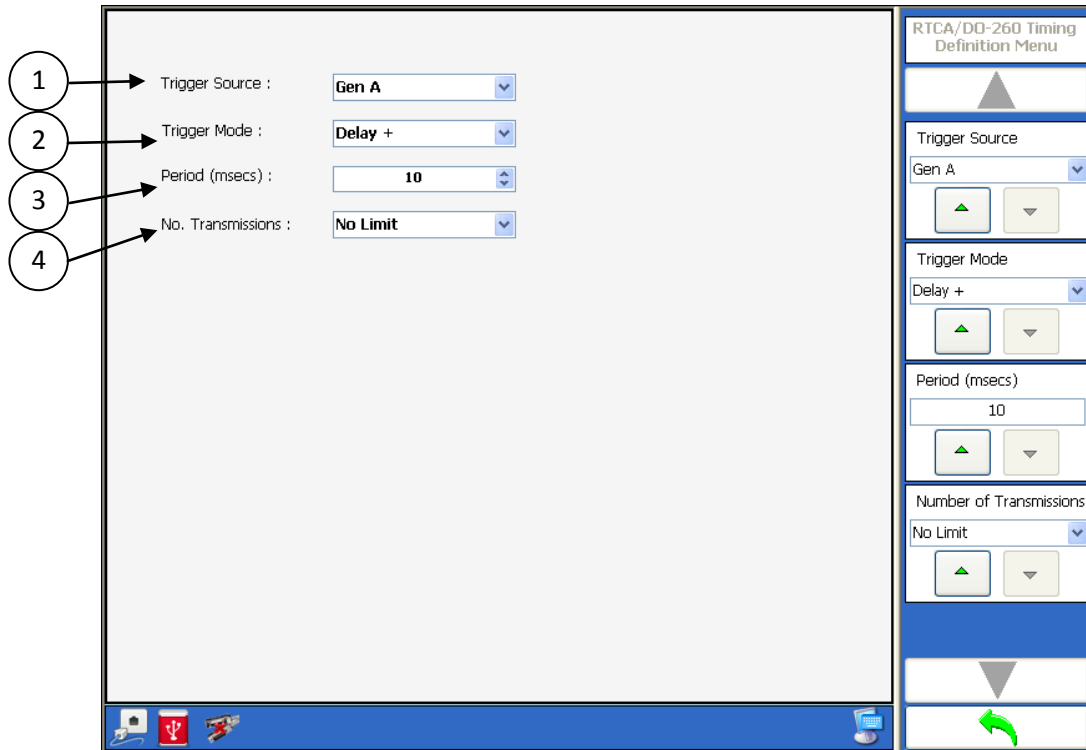

Figure 3.1.2.4.1.7 – RTCA/DO-260 Timing Definition Menu

Menu Control	Function
1	Trigger Source combobox allows selection of generator to trigger from.
2	Trigger Mode combobox allows selection of mode (Delay +, Delay -, walk). If random is selected then two more numeric boxes are added to the screen to select minimal starting time and the width of the random starting time. If delay is selected then the delay defined in the generator setting is used for + or – delay. Walk allows setting a signal at a positive or negative delay and moving the signal by 25 nanosecond delay every transmission.
3	Period numeric box allows selection of time between triggers (10 to 2000 milliseconds).
4	Number of Transmissions combobox allows selection of transmissions (No limit, 20, 40, 60, 100, 200, 400, 600, 945, 1000, 2000, 4000, 6000, or 10000).

Softkey	Function
Trigger Source	Same as menu control item 1.
Trigger Mode	Same as menu control item 2.
Period	Same as menu control item 3.
Number of Transmissions	Same as menu control item 4.

Softkey	Function
Random Start	See menu control 2.
Random Width	See menu control 2.

Figure 3.1.2.4.1.8 illustrates the RTCA/DO-260 Generator Definition Menu. This menu allows the operator to specify the generator parameters for delay triggering.

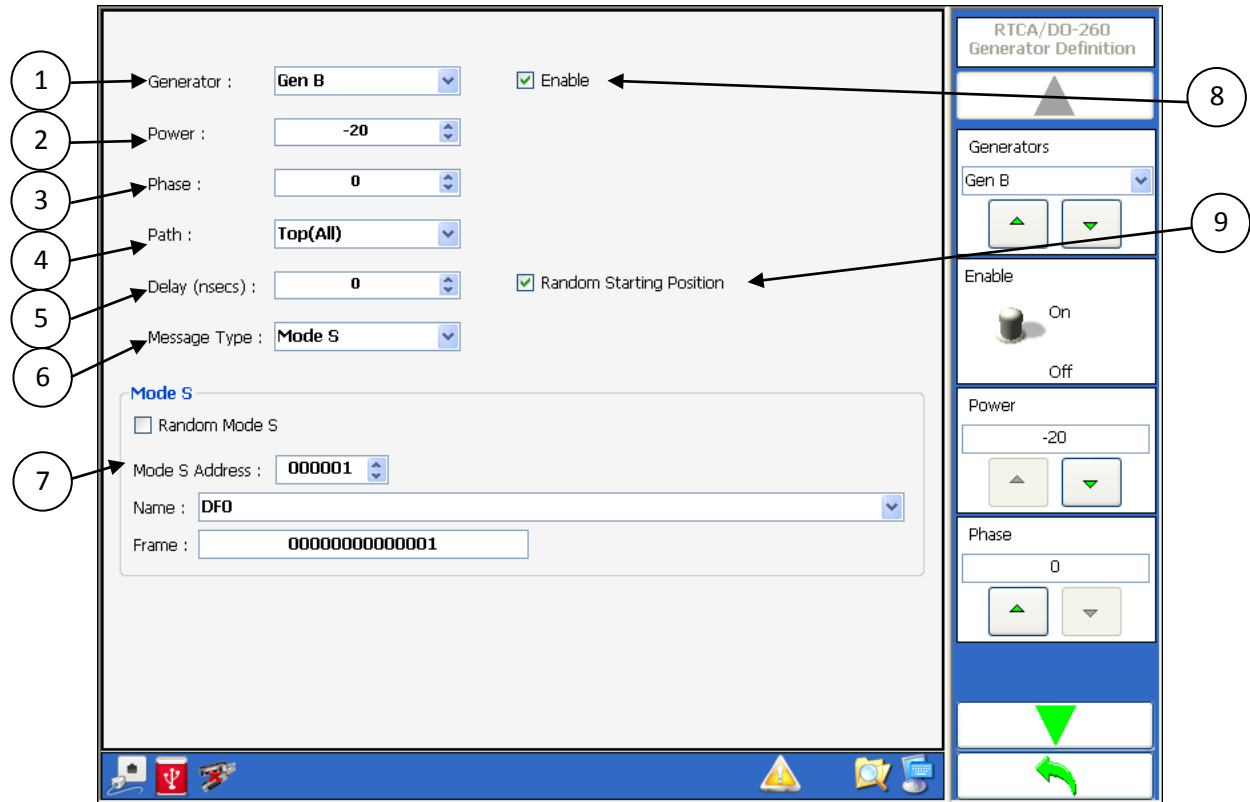

Figure 3.1.2.4.1.8 – RTCA/DO-260 Generator Definition Menu for Delay Triggering

Menu Control	Function
1	Generator combobox allows selection of generator.
2	Power numeric box allows setting the output power of the generator.
3	Phase numeric box allows setting the output phase of the generator.
4	Path combobox allows setting the path of the generator to top or bottom.
5	Delay numeric box allows setting the delay from the trigger source. If the generator that is being set is the trigger source, this parameter is disabled. The delay value will be either positive or negative in accordance with the setting in the timing definition of delay+ or delay-. The range is from 0 to 120000 nanoseconds in 100 nanosecond steps.
6	Message Type combobox allows selecting between Mode S or ATCRBS message. If the generator that is being set is the trigger source, this parameter is disabled and set to Mode S.

Menu Control	Function
7	Message Definition section allows the operator to set the message. For Mode S the parameters that can be set are Mode S Address, Mode S Message Type, and whether the data is random excluding the first five bits and the PI field. For ATRBS the parameters that can be set are Mode A Code or random (2 frame pulses with 5 random data pulses).
8	Enable checkbox allows enabling or disabling the generator for the test. If the generator selected is the trigger source, this parameter is disabled and the generator is enabled.
9	Random Starting Position will change the starting position of each message from the delay value.

Softkey	Function
Generators	Same as menu control item 1.
Enable	Same as menu control item 8.
Power	Same as menu control item 2.
Phase	Same as menu control item 3.
Path	Same as menu control item 4.
Delay	Same as menu control item 5.
Message Type	Same as menu control item 6.
Mode S →	See menu control item 7. Random Squitter Name Mode S Address Frame Details
Mode A/Mode C →	See menu control item 7. Random A B C D Ident
Random Starting Position	Same as menu control item 9.

Figure 3.1.2.4.1.9 illustrates the RTCA/DO-260 Generator Definition Menu. This menu allows the operator to specify the generator parameter for walk triggering.

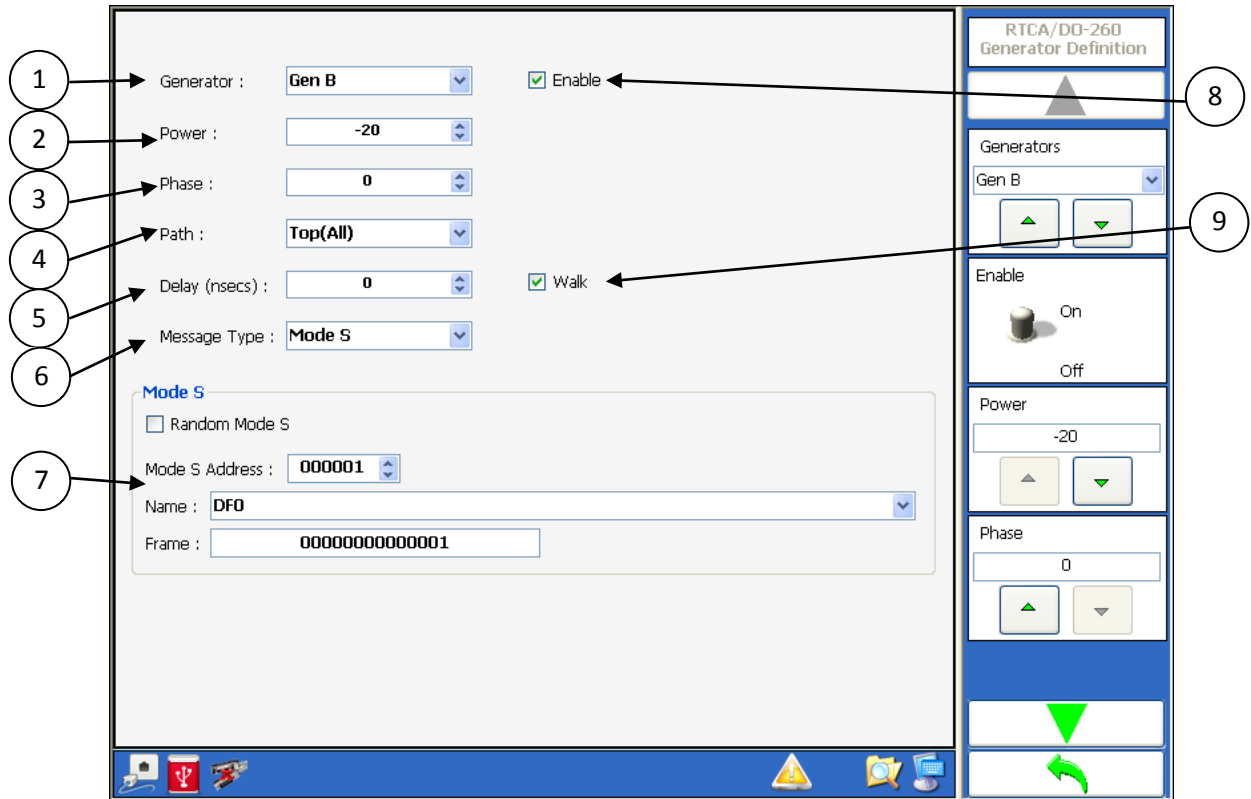

Figure 3.1.2.4.1.9 – RTCA/DO-260 Generator Menu for Walk Triggering

Menu Control	Function
1	Generator combobox allows selection of generator.
2	Power numeric box allows setting the output power of the generator.
3	Phase numeric box allows setting the output phase of the generator.
4	Path combobox allows setting the path of the generator to top or bottom.
5	Delay numeric box allows setting the delay from the trigger source. If the generator that is being set is the trigger source, this parameter is disabled. The delay range is from -120000 to 120000 nanoseconds in 100 nanosecond steps.
6	Message Type combobox allows selecting between Mode S or ATCRBS message. If the generator that is being set is the trigger source, this parameter is disabled and set to Mode S.
7	Message Definition section allows the operator to set the message. For Mode S the parameters that can be set are Mode S Address, Mode S Message Type, and whether the data is random excluding the first five bits and the PI field. For ATCRBS the parameters that can be set are Mode A Code or random (2 frame pulses with 5 random data pulses).

Menu Control	Function
8	Enable checkbox allows enabling or disabling the generator for the test. If the generator selected is the trigger source, this parameter is disabled and the generator is enabled.
9	Walk checkbox allows enabling or disabling the walk function for the generator. If walk is disabled the output will be at the delay parameter specified and will not move. If walk is enabled then the message will start at the delay parameter and move 25 nanoseconds every transmission.

Softkey	Function
Generators	Same as menu control item 1.
Enable	Same as menu control item 8.
Power	Same as menu control item 2.
Phase	Same as menu control item 3.
Path	Same as menu control item 4.
Delay	Same as menu control item 5.
Message Type	Same as menu control item 6.
Mode S →	See menu control item 7. Random Squitter Name Mode S Address Frame Details
Mode A/Mode C →	See menu control item 7. Random A B C D Ident
Walk	Same as menu control item 9.

3.1.2.4.2. Block Transmission

Figure 3.1.2.4.2.1 illustrates the TTG-7000 Block Transmission Menu. The TTG-7000 Block Transmission Menu allows the user to define a block of 1090/1030 messages to transmit with a specific timing and at a specified periodic timing.

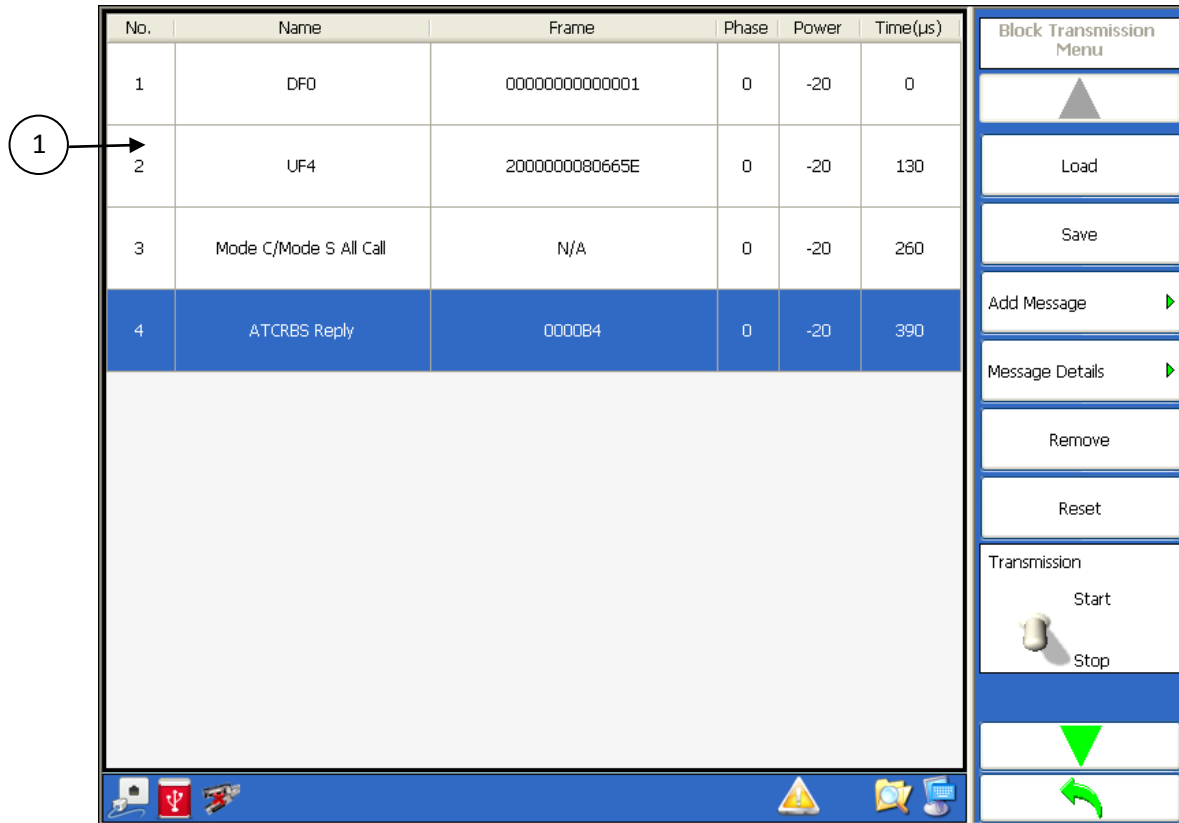

Figure 3.1.2.4.2.1 – TTG7000 Block Transmission Menu

Menu Control	Function
1	Illustrates the message sequence defined for the block

Softkey	Function
Load	Load a Block Transmission sequence from the internal data location or an external drive if present.
Save	Save a Block Transmission sequence to the internal data location or an external drive if present.
Add Message	Adds a new message to the sequence and open Add Message Menu to allow definition of the message.
Message Details	Opens Message Detail Menu to allow modifying the parameters of the selected message.

Softkey	Function
Remove	Removes the selected message from the block sequence.
Reset	Clears the entire block sequence.
Transmission Start/Stop	Allows starting and stopping the block transmissions.
Frame Period	Sets the frame period for the block transmissions. Range from 10 milliseconds to 50 seconds.
Mode	Set to continuous transmissions or interrupted. If interrupted is selected than two more softkeys are displayed (Hit and Miss)
No Limit Transmission	If no limit transmission is set then TTG7000 will continue to transmit block sequences until the transmission stop command or switch is turned off. If no limit transmission is turned off, then the softkey for Number of Transmissions will be illustrated.
Hit	Sets how many groups of block sequences will be transmitted before the next miss group. Range 0 to 20.
Miss	Sets how many groups of block sequences will not be transmitted before the next hit group. Range 0 to 20.
Number of Transmissions	Sets the number of block sequences to transmit. Range from 1 to 50000.

Figure 3.1.2.4.2.2 illustrates the TTG-7000 Block Transmission Add Message Menu. This menu allows the user to define the parameters for the new message that was added. The menu allows selection of 1030/1090 messages, Mode S/ATCRBS, power, phase, and transmission time.

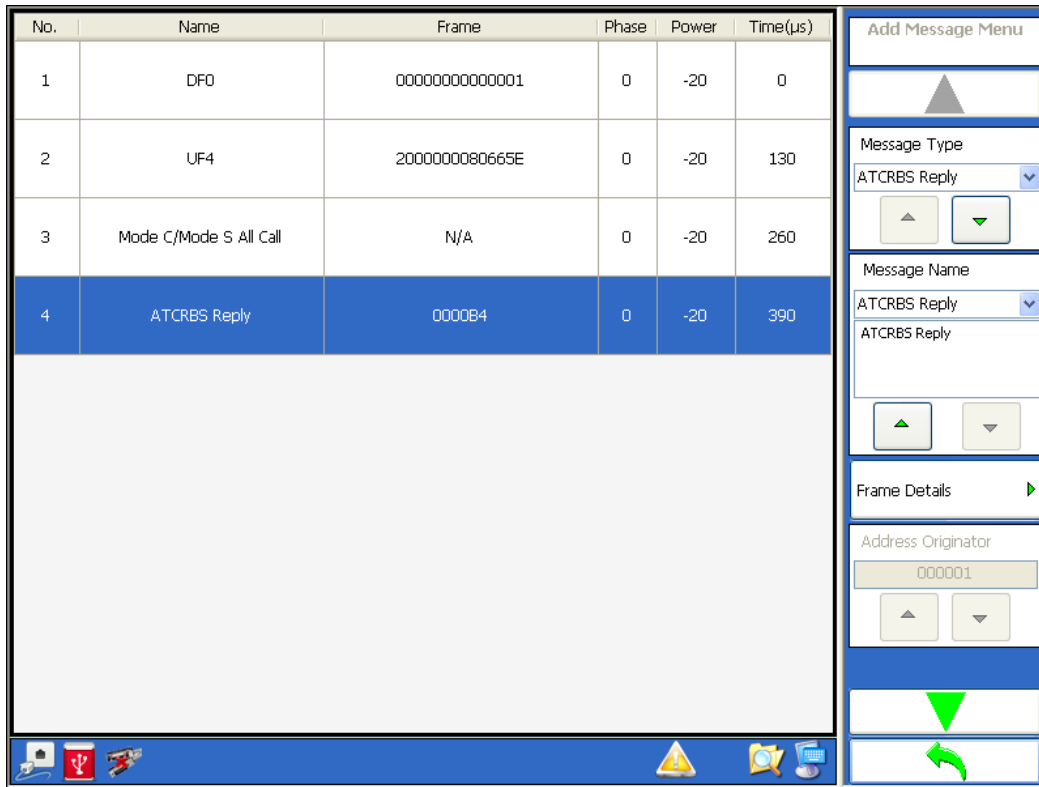

Figure 3.1.2.4.2.2 – TTG7000 Block Transmission Add Message Menu

Softkey	Function
Message Type	Message Type allows selection of Mode S Interrogation, Mode S Replies, ATCRBS Interrogation, or ATCRBS Replies.
Message Name	Message Name is the subcategory of message within the Message Type selected. For example, Message Type is Mode S Replies, then Message Name could be DF0, DF4, DF5, DF16, etc.
Frame Details	Opens a new menu that illustrates the detail information about the message defined.
Address Originator	The value used in the AP field to generate the PI field of a Mode S reply. [DF Messages]
Transponder Address	The value used in the AP field to generate the PI field of a Mode S interrogation. [UF Messages]
Phase	Allows setting the phase of the message from 0 to 359 degrees.
Power Level	Allows setting the power level of the message.
Time	Allows setting the transmission time within the block of messages.

Figure 3.1.2.4.2.3 illustrates the TTG-7000 Block Transmission Message Frame Detail Menu. This menu allows the user to update the fields of the selected message.

Name	Value	Units	LSB	Description	Low	High	Invalid
DF	0	N/A	0		0	0	False
VS	0	N/A	0	Airborne	0	1	False
CC	0	N/A	0	Crosslink Not Supported	0	1	False
Spare	0	N/A	0		0	0	False
SL	0	N/A	0	No TCAS Sensitivity Level	0	7	False
Spare	0	N/A	0		0	0	False
RI	0	N/A	0	Non on-board TCAS	0	15	False
Spare	0	N/A	0		0	0	False
AC	-1300	N/A	1		-1300	128000	False

Frame Details Menu

▲

DF

0

▲ ▼

VS

Airborne ▼

▲ ▼

CC

Crosslink Not Supporte ▼

▲ ▼

Spare

0

▲ ▼

▼

↻

Figure 3.1.2.4.2.3 – TTG7000 Block Transmission Frame Detail Menu

3.1.2.5. TCAS Scenario Menu

Figure 3.1.2.5.1 illustrates the TTG-7000 TCAS Scenario Menu. The TCAS Scenario Menu allows the user to define a specific scenario for testing a TCAS System. The user can define thirty two (32) dynamic and five hundred and sixty eight (568) static intruders. The user can define a Mode S Only, Mode S Extended (ADS-B), TIS-B (DF18), and ATCRBS (Mode A/C) intruders.

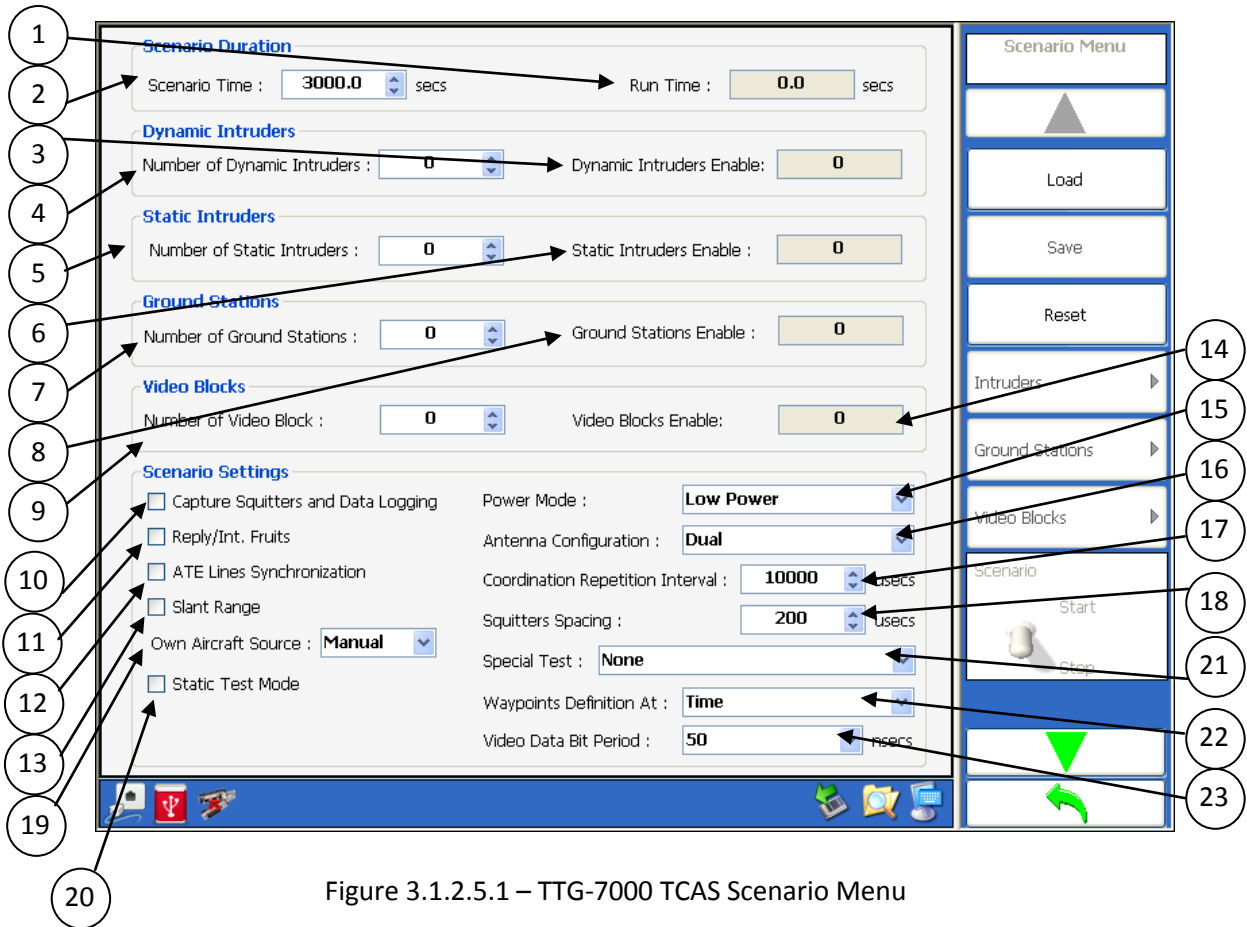

Figure 3.1.2.5.1 – TTG-7000 TCAS Scenario Menu

Menu Control	Function
1	Scenario Current Run Time
2	Scenario Time numeric box. Maximum scenario time (duration) is 3000 seconds.
3	Number of dynamic intruders enabled
4	Number of dynamic intruders defined for the scenario. Maximum number of dynamic intruders is 32.
5	Number of static intruders defined for the scenario. Maximum number of static

Menu Control	Function
	intruders is 568.
6	Number of static intruders enabled
7	Number of Ground Stations defined for the scenario. Maximum number of ground stations is 15.
8	Number of Ground Stations enabled
9	Number of Video Blocks. Maximum number of Video Blocks is 12.
10	Capture Squitters and Datalogging checkbox allows the user to log all the messages received during the scenario according to the message mask assigned in the Receiver menu. The data log is reset at the start of scenario.
11	Fruit enable/disable checkbox
12	ATE Line Synchronization checkbox. If synchronization is enabled, then all scenario run time is synchronized to TCAS TISI sequence. (ATE Lines need to be attached to test set)
13	Slant Range. If enabled the TTG-7000 calculates the range using the intruder range, intruder altitude, and own aircraft altitude. If disabled the range is the horizontal range that is defined in the intruder definition.
14	Number of Video Blocks enabled.
15	Power Mode. The user can select between high or low power modes. High power mode allows output of 1 to -69 dBm and low power allows -20 to -90 dBm.
16	Sets the TTG-7000 to allow dual antenna; top only or bottom only setup.
17	Coordination Repetition Interval is the time interval between coordination interrogations if TCAS system does not reply. The maximum number of repetition is ten (10) interrogations. Interval range from 1000 to 65000 microseconds. Default is 10000 microseconds.
18	Squitter Spacing. Allows setting the time spacing between squitters from 200 to 500 microseconds. Default is 200 microseconds.
19	Own Aircraft Source Combobox. Allows the own aircraft data to be entered manually, through 429, or external (TCP/IP).
20	Static Mode. Static mode allows the dynamic intruders to stay active after the runtime has reached the scenario time with their last position.
21	Special Test Combobox [Customer Specific]
22	Waypoint Definition. Allows setting waypoints either by time, location (latitude and longitude realistic airplane simulation) or forced trajectory (latitude and longitude pass over).
23	Video Data Bit Period. Allows setting the period of a Video Block Data Bit to either 25 or 50 nanosecond.

Softkey	Function
Load	Opens a file dialog to allow the user to load a saved scenario configuration.
Save	Allows saving the current scenario configuration to a file.
Reset	Resets all intruders, ground stations, and video

Softkey	Function
	blocks.
Intruders→ Mode S Dynamic Mode S Static Mode C Dynamic Mode C Static Mode S Extended Dynamic Mode S Extended Static TIS-B Only Dynamic TIS-B Only Static ADS-R Dynamic ADS-R Static	Opens the intruder definition menu
Ground Stations	
Video Blocks	
Scenario Stop/Start	Starts or stops scenario
Scenario Time	Same as menu control item 2.
Number of Statics	Same as menu control item 5.
Number of Dynamics	Same as menu control item 4.
Number of Gnd Stations	Same as menu control item 7.
Number of Video Blocks	Same as menu control item 9.
Reply/Int Fruit	Same as menu control item 11.
ATE Lines Synchronization	Same as menu control item 12.
Capture	Same as menu control item 10.
Slant Range	Same as menu control item 13.
Own Aircraft Source	Same as menu control item 19.
Static Mode	Same as menu control item 20.
Power Mode	Same as menu control item 15.
Antenna Configuration	Same as menu control item 16.
Coord Repetition	Same as menu control item 17.
Squitter Spacing	Same as menu control item 18.
Special Test	Same as menu control item 21.
Waypoint By	Same as menu control item 22.
Data Bit Period	Same as menu control item 23.
ATCRBS Pulse Information→	Opens ATCRBS Pulse definition menu
Mode S Pulse Information →	Opens Mode S Pulse definition menu
Display Menu	

3.1.2.5.1. Static Mode S TCAS Only Definition Menu

Figure 3.1.2.5.1.1 illustrates the TTG-7000 Static Mode S TCAS Only Definition Menu. The Static Mode S TCAS Only Definition Menu allows the user to define a static Mode S only (non ADS-B) intruder.

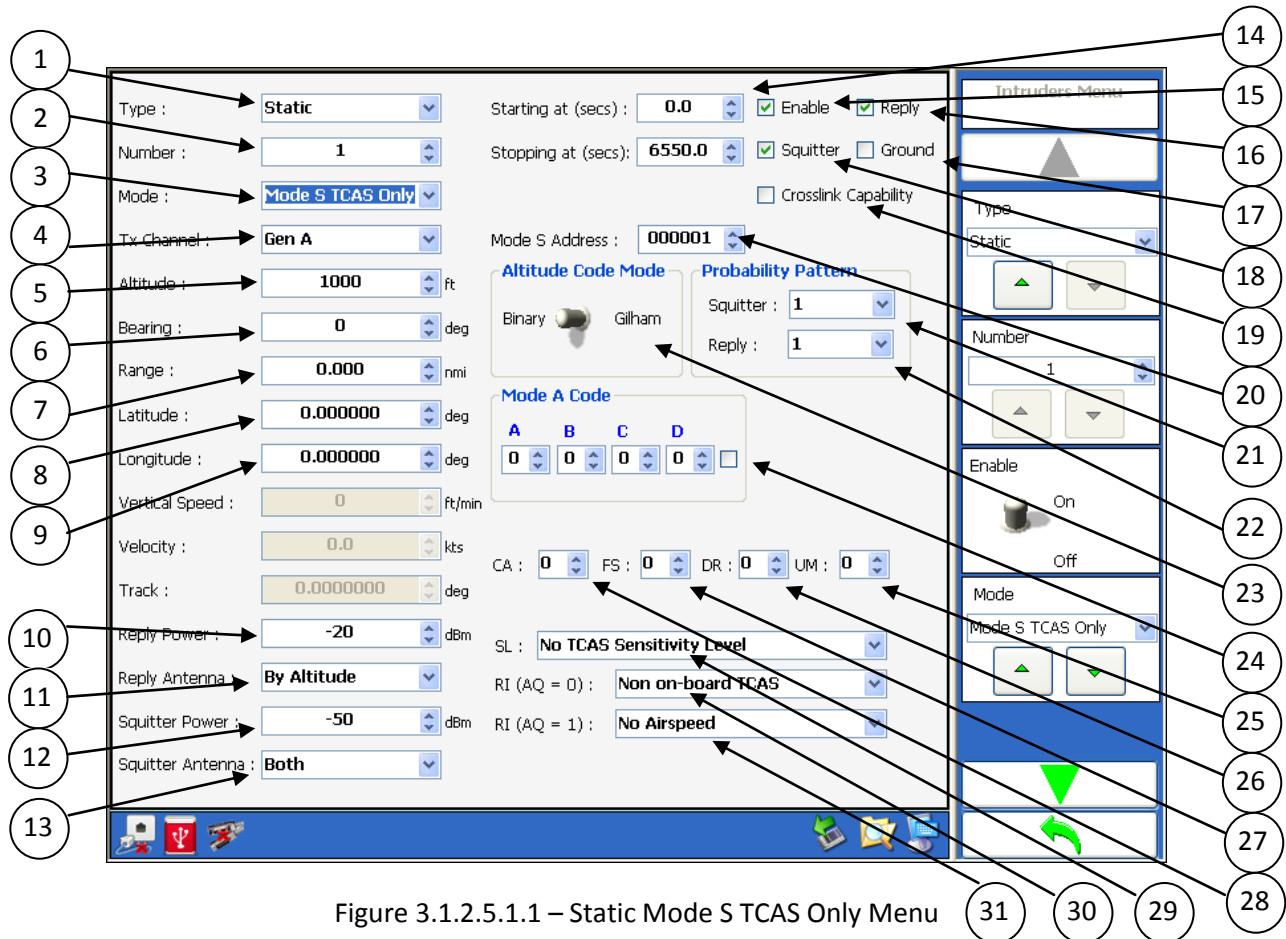

Figure 3.1.2.5.1.1 – Static Mode S TCAS Only Menu

Menu Control	Function
1	Type combobox. (Dynamic or Static)
2	Number numeric box. (Dynamic: 1-32; Static: 1-468)
3	Mode combobox. (Mode S TCAS Only, Mode S Extended, Mode C, TIS-B, ADS-R)
4	Tx Channel combobox. User can select from one of three possible transmitters.
5	Altitude numeric box. Binary range from -1000 to 50175 feet in 25 feet steps. Gilham range from -1000 to 126700 feet in 100 feet steps.
6	Bearing (Phase) numeric box. Range 0 – 359 degrees in 1-degree steps.
7	Range numeric box. Range from 0 to 160 nautical miles.

Menu Control	Function
8	Latitude. Range from -90 to 90 degrees.
9	Longitude. Range from -180 to 180 degrees.
10	Reply Power numeric box. Low power range -20 to -90 dBm in 1 dB steps. High power range from 1 to -69 dBm.
11	Reply Antenna (Bottom Only, Top Only, Alternating, Both, By Altitude)
12	Squitter Power numeric box. Low power range -20 to -90 dBm in 1 dB steps. High power range from 1 to -69 dBm.
13	Squitter Antenna (Top Only, Bottom Only, Both)
14	Start/Stop Time.
15	Enable checkbox. If checked then test set will transmit the required messages for this intruder.
16	Reply checkbox. If checked then the intruder will reply to interrogations.
17	Ground checkbox allows the user to set VS bit for the intruder.
18	Squitter Enable.
19	Crosslink Capability checkbox.
20	Mode S Address numeric box. Mode S Address expressed in hexadecimal.
21	Squitter Probability Pattern combobox. (Values: 1.0, 0.8, 0.6, 0.4, 0.2)
22	Reply Probability Pattern combobox. (Values: 1.0, 0.8, 0.6, 0.4, 0.2)
23	Altitude Mode switch. (Gilham or Binary)
24	Mode A Code.
25	Utility Message (UM) Field.
26	Downlink Request (DR) Field.
27	Flight Status (FS) Field.
28	Transponder Capability (CA) Field.
29	SL combobox
30	RI (AQ = 0) combobox
31	RI (AQ = 1) combobox

Softkey	Function
Type	Same as menu control item 1.
Number	Same as menu control item 2.
Enable	Same as menu control item 15.
Mode	Same as menu control item 3.
Starting At	Same as menu control item 14.
Stopping At	Same as menu control item 14.
Reply	Same as menu control item 16.
Squitter	Same as menu control item 18.
Ground	Same as menu control item 17.
Crosslink Capability	Same as menu control item 19.
Mode S Address	Same as menu control item 20.
Tx Channel	Same as menu control item 4.
Coordination Message Definition	
Broadcast Message Definition	

Softkey	Function
DF16 Reply Message Menu	
UF0 Message Menu	
One Shot Data	
Altitude Code Mode	Same as menu control item 23.
Altitude	Same as menu control item 5.
Bearing	Same as menu control item 6.
Range	Same as menu control item 7.
Latitude	Same as menu control item 8.
Longitude	Same as menu control item 9.
Reply Power	Same as menu control item 10.
Reply Antenna	Same as menu control item 11.
Squitter Power	Same as menu control item 12.
Squitter Antenna	Same as menu control item 13.
Squitter Probability Pattern	Same as menu control item 21.
Reply Probability Pattern	Same as menu control item 22.
Mode A Code (A)	Same as menu control item 24.
Mode A Code (B)	Same as menu control item 24.
Mode A Code (C)	Same as menu control item 24.
Mode A Code (D)	Same as menu control item 24.
Ident Bit	Same as menu control item 24.
Transponder Capability (CA) Field	Same as menu control item 28.
Flight Status (FS) Field	Same as menu control item 27.
Downlink Request (DR) Field	Same as menu control item 26.
Utility Message (UM) Field	Same as menu control item 25.
Sensitivity Level	Same as menu control item 29.
RI (AQ=0)	Same as menu control item 30.
RI (AQ=1)	Same as menu control item 31.

3.1.2.5.1.1. Coordination Message Menu

Figure 3.1.2.5.1.1.1 illustrates the TTG-7000 Coordination Message Definition Menu. The Coordination Message Definition Menu allows the user to define the coordination message of a Mode S intruder.

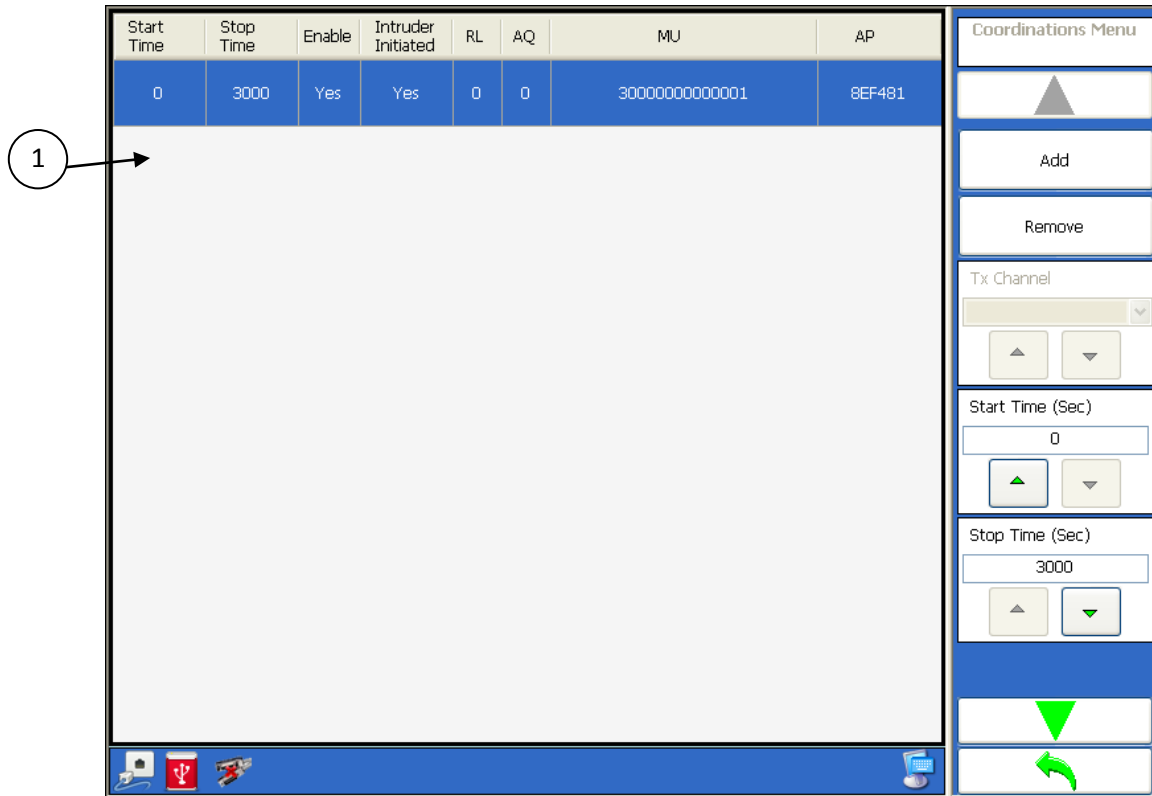

Figure 3.1.2.5.1.1.1 – Coordination Message Menu

Menu Control	Function
1	Data grid of all defined coordination messages.

Softkey	Function
Add	Adds a new coordination message.
Remove	Removes the selected coordination message.
Start Time	Allows setting the start time of the selected coordination message.
Stop Time	Allows setting the stop time of the selected coordination message.

Softkey	Function
Reply Length	Allows setting the RL bit of the coordination message.
Acquisition Special	Allows setting the AQ bit of the coordination message.
Enable	Allows enabling or disabling coordination messages.
Intruder Initiated	If yes (on) then the intruder sends the coordination message at the appropriate time specified. If no (off) then the intruder waits for a UUT coordination message at the appropriate time before transmitting a coordination message.
MU Field Menu	See Figure 3.1.2.5.1.1.2

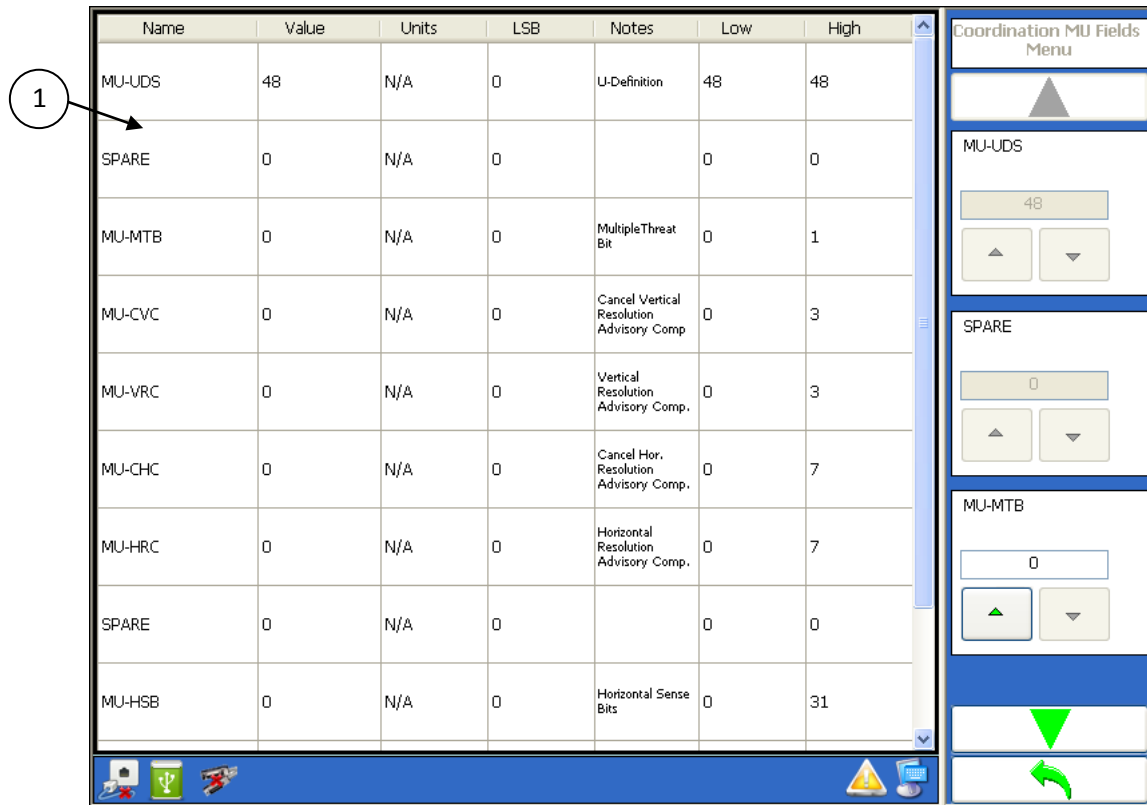

Figure 3.1.2.5.1.1.2 – Coordination Message MU Field Menu

Menu Control	Function
1	Breakdown of the coordination message.

Softkey	Function
MU-MTB	

Softkey	Function
MU-CVC	
MU-VRC	
MU-CHC	
MU-HRC	
MU-HSB	
MU-VSB	
MU-MID	

3.1.2.5.1.2. Broadcast Message

Figure 3.1.2.5.1.2.1 illustrates the TTG-7000 Broadcast Message Definition Menu. The Broadcast Message Definition Menu allows the user to define the broadcast message of a Mode S intruder.

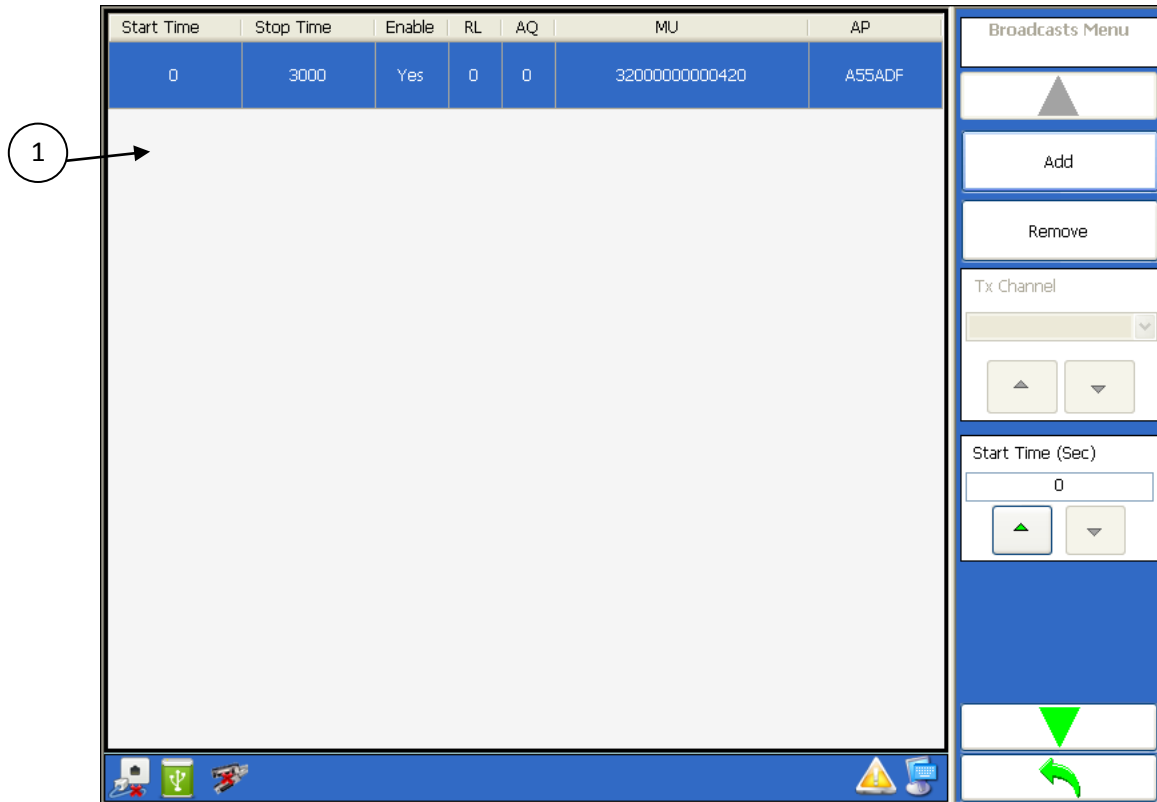

Figure 3.1.2.5.1.2.1 – Broadcast Message Menu

Menu Control	Function
1	Data grid of all defined broadcast messages.

Softkey	Function
Add	Adds a new broadcast message.
Remove	Removes the selected broadcast message.
Start Time	Allows setting the start time of the selected broadcast message.
Stop Time	Allows setting the stop time of the selected broadcast message.

Softkey	Function
Reply Length	Allows setting the RL bit of the broadcast message.
Acquisition Special	Allows setting the AQ bit of the broadcast message.
Enable	Allows enabling or disabling broadcast messages.
MU Field Menu	See Figure 3.1.2.5.1.2.2

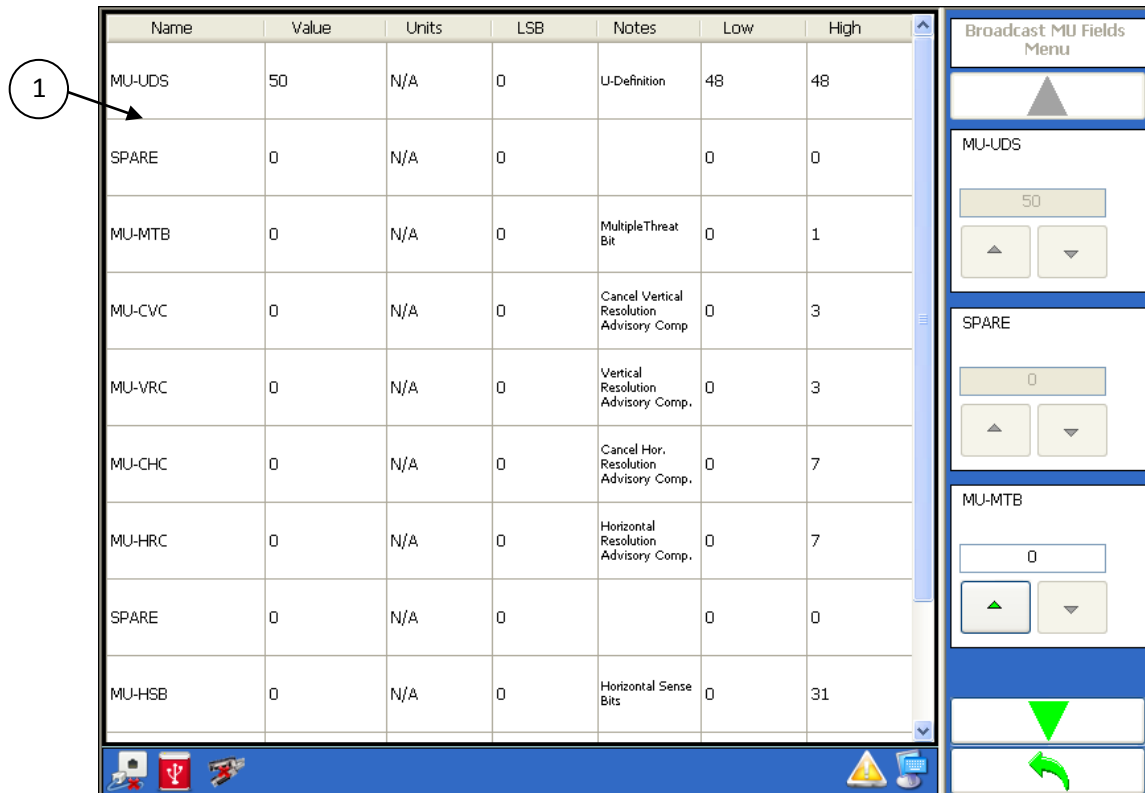

Figure 3.1.2.5.1.2.2 – Broadcast Message MU Field Menu

Menu Control	Function
1	Breakdown of the Broadcast message.

Softkey	Function
MU-MTB	
MU-CVC	
MU-VRC	
MU-CHC	
MU-HRC	

Softkey	Function
MU-HSB	
MU-VSB	
MU-MID	

3.1.2.5.1.3. Coordination Replies (DF16 Replies)

Figure 3.1.2.5.1.3.1 illustrates the TTG-7000 Coordination Reply Message Definition Menu. The Coordination Reply Message Definition Menu allows the user to define the coordination reply message of a Mode S intruder.

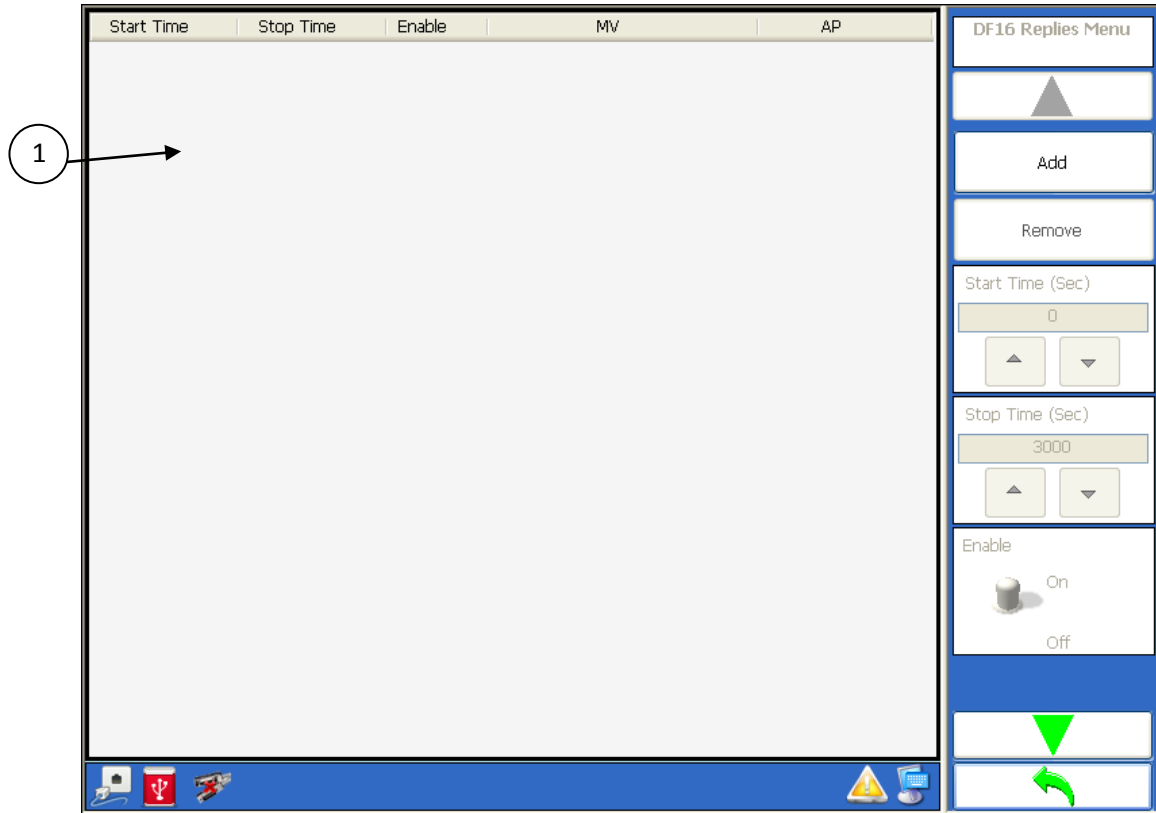

Figure 3.1.2.5.1.3.1 – Coordination Reply Message Menu

Menu Control	Function
1	Data grid of all defined coordination replies messages.

Softkey	Function
Add	Adds a new coordination reply.
Remove	Removes the selected coordination reply.
Start Time	Allows setting the start time of the selected coordination replies message.
Stop Time	Allows setting the stop time of the selected

Softkey	Function
	coordination replies message.
Enable	Allows enabling or disabling coordination replies messages.
MV Field Menu	See Figure 3.1.2.5.1.3.2

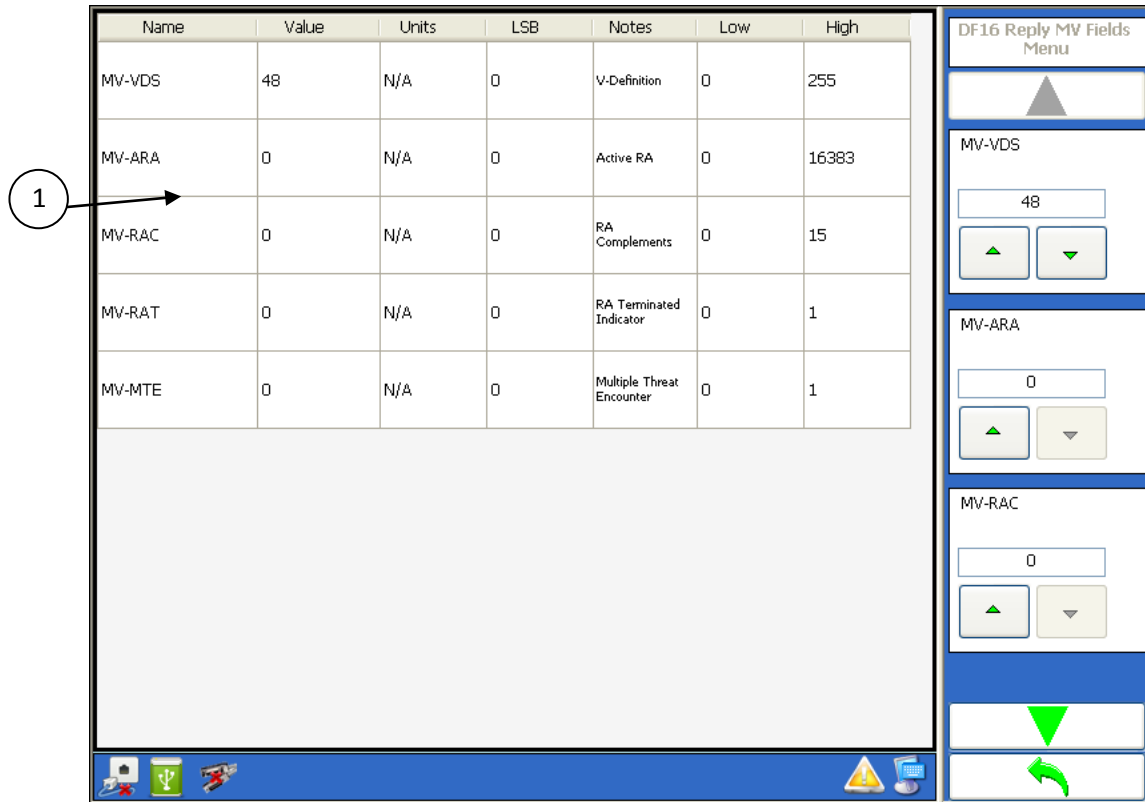

Figure 3.1.2.5.1.3.2 – Coordination Reply Message MV Field Menu

Menu Control	Function
1	Breakdown of the coordination reply message.

Softkey	Function
MV-VDS	
MV-ARA	
MV-RAC	
MV-RAT	
MV-MTE	

3.1.2.5.1.4. UFO Messages

Figure 3.1.2.5.1.4.1 illustrates the TTG-7000 UFO Message Definition Menu. The UFO Message Definition Menu allows the user to define the UFO interrogation messages of a Mode S intruder.

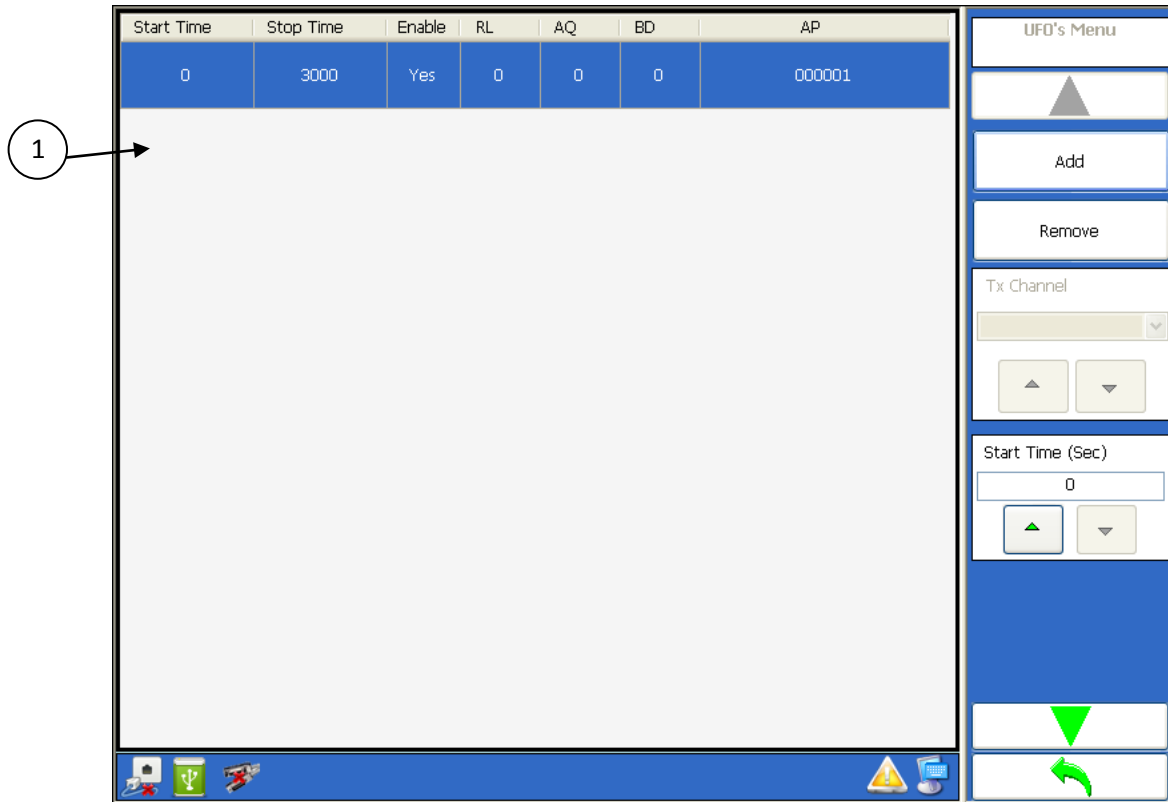

Figure 3.1.2.5.1.4.1 – UFO Message Menu

Menu Control	Function
1	Data grid of all defined UFO messages.

Softkey	Function
Add	Adds a new UFO interrogation.
Remove	Remove the selected UFO interrogation.
Start Time	Allows setting the start time of the selected UFO message.
Stop Time	Allows setting the stop time of the selected UFO message.

Softkey	Function
Reply Length	Allows setting the RL bit of the UFO message.
Acquisition Special	Allows setting the AQ bit of the UFO message.
BDS	Allows setting the BDS register of the UFO message.
Enable	Allows enabling or disabling UFO messages.

3.1.2.5.2. Dynamic Mode S TCAS Only Definition Menu

Figure 3.1.2.5.2.1 illustrates the TTG-7000 Dynamic Mode S TCAS Only Definition Menu. The Dynamic Mode S TCAS Only Definition Menu allows the user to define all the parameters for a dynamic Mode S intruder.

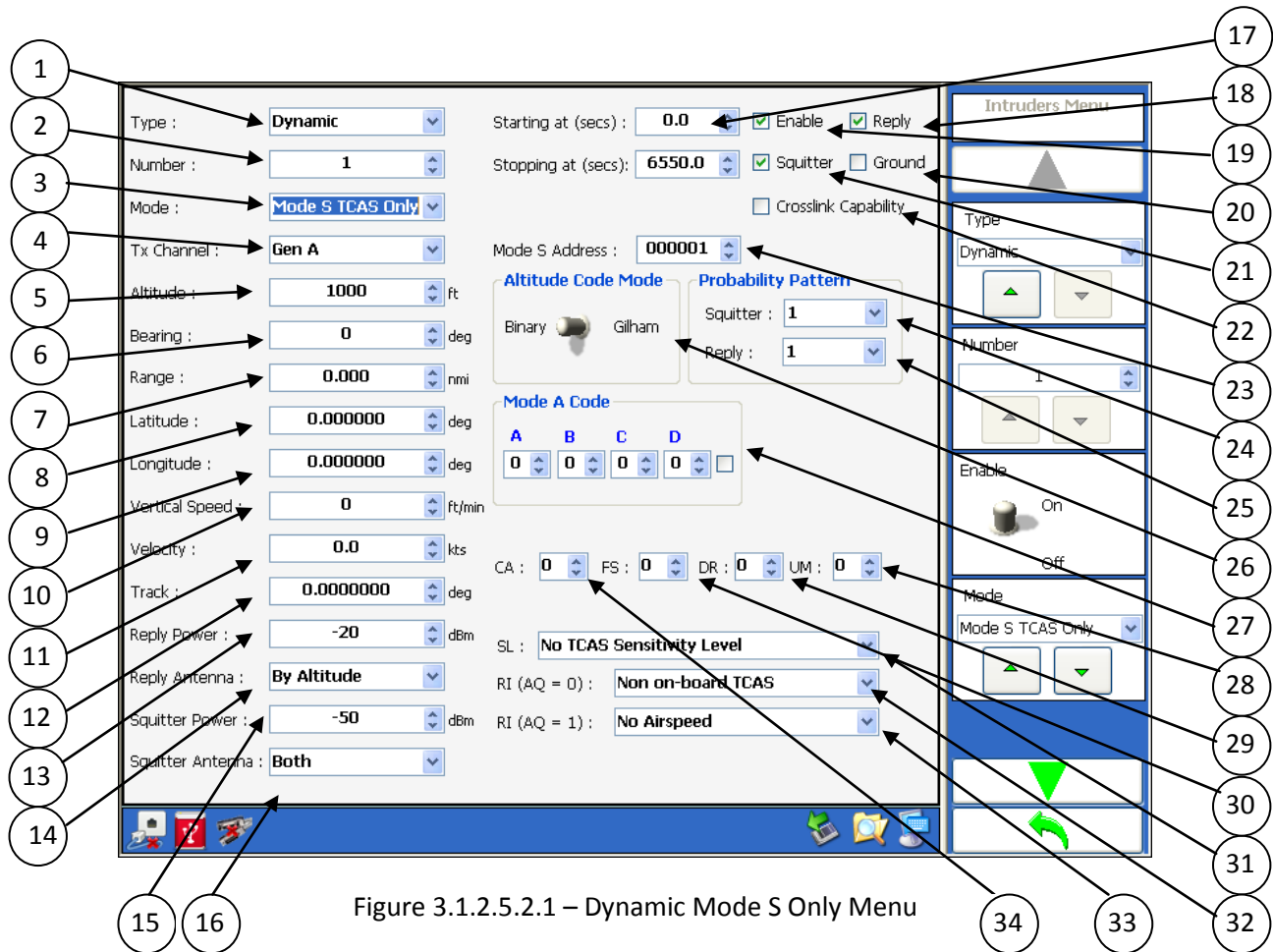

Figure 3.1.2.5.2.1 – Dynamic Mode S Only Menu

Menu Control	Function
1	Type combobox. (Dynamic or Static)
2	Number numeric box. (Dynamic: 1-32; Static: 1-400)
3	Mode combobox. (Mode S TCAS Only, Mode S Extended, Mode C, TIS-B, ADS-R)
4	Tx Channel combobox. User can select from one of three possible transmitters.
5	Altitude numeric box. Binary range from -1000 to 50175 feet in 25 feet steps. Gilham range from -1000 to 126700 feet in 100 feet steps.
6	Bearing (Phase) numeric box. Range 0 – 359 degrees in 1-degree steps.

Menu Control	Function
7	Range numeric box. Range from 0 to 160 nautical miles.
8	Latitude. Range -90 to 90 degrees.
9	Longitude. Range -180 to 180 degrees.
10	Vertical Speed numeric box. Range from – 32576 to 32576 ft/min in 64 ft/min steps.
11	Velocity numeric box. Range 0 to 2000 knots.
12	Track Angle numeric box. Value range from -180 to 180 degrees in 1-degree steps.
13	Reply Power numeric box. Low power range -20 to -90 dBm in 1 dB steps. High power range from 1 to -69 dBm.
14	Reply Antenna combobox. (Top Only, Bottom Only, Alternating, Both, By Altitude)
15	Squitter Power numeric box. Low power range -20 to -90 dBm in 1 dB steps. High power range from 1 to -69 dBm.
16	Squitter Antenna combobox. (Top Only, Bottom Only, Both)
17	Start and Stop numeric box. This time is when the intruder will be present.
18	Reply checkbox. If enabled then the intruder will reply to interrogations.
19	Intruder checkbox. If enabled then test set will transmit the required messages for this intruder.
20	Ground checkbox allows the user to set VS bit for the intruder.
21	Squitter checkbox. If enabled squitter are active.
22	Crosslink Capability checkbox.
23	Mode S Address numeric box. Mode S Address defined in hexadecimal.
24	Squitter Probability Pattern combobox. (Values: 1.0, 0.8, 0.6, 0.4, 0.2)
25	Reply Probability Pattern combobox. (Values: 1.0, 0.8, 0.6, 0.4, 0.2)
26	Altitude Mode switch. (Gilham or Binary)
27	Mode A Code
28	Utility Message (UM) Field
29	Downlink Request (DR) Field
30	Flight Status (FS) Field
31	SL combobox
32	RI (AQ = 0) combobox
33	RI (AQ = 1) combobox
34	Transponder Capability (CA) Field

Softkey	Function
Intruder Type	Same as menu control item 1
Intruder Number	Same as menu control item 2
Intruder Mode	Same as menu control item 3
Start Time	Same as menu control item 17
Stop Time	Same as menu control item 17
Enable	Same as menu control item 19
Reply	Same as menu control item 18
Squitter	Same as menu control item 21
Ground	Same as menu control item 20
Crosslink Capability	Same as menu control item 22

Softkey	Function
Mode S Address	Same as menu control item 23
Tx Channel	Same as menu control item 4
Coordination Message Definition	
Broadcast Message Definition	
DF16 Reply Message Menu	
UF0 Message Menu	
One Shot Data	
Waypoints	
Altitude Code	Same as menu control item 26
Altitude	Same as menu control item 5
Bearing (Phase)	Same as menu control item 6
Range	Same as menu control item 7
Latitude	Same as menu control item 8
Longitude	Same as menu control item 9
Velocity	Same as menu control item 11
Vertical Speed	Same as menu control item 10
Track	Same as menu control item 12
Reply Power	Same as menu control item 13
Reply Antenna	Same as menu control item 14
Squitter Power	Same as menu control item 15
Squitter Antenna	Same as menu control item 16
Reply Probability Pattern	Same as menu control item 25
Squitter Probability Pattern	Same as menu control item 24
Mode A Code (A)	Same as menu control item 27
Mode A Code (B)	Same as menu control item 27
Mode A Code (C)	Same as menu control item 27
Mode A Code (D)	Same as menu control item 27
Ident Bit	Same as menu control item 27
Transponder Capability (CA) Field	Same as menu control item 34
Flight Status (FS)	Same as menu control item 30
Downlink Request (DR)	Same as menu control item 29
Utility Message (UM)	Same as menu control item 28
Sensitivity Level	Same as menu control item 31
RI (AQ=0)	Same as menu control item 32
RI (AQ=1)	Same as menu control item 33

3.1.2.5.3. Static Mode C Definition Menu

Figure 3.1.2.5.3.1 illustrates the TTG-7000 Static Mode C Definition Menu. The Static Mode C Definition Menu allows the user to define all the parameters for static Mode C intruder.

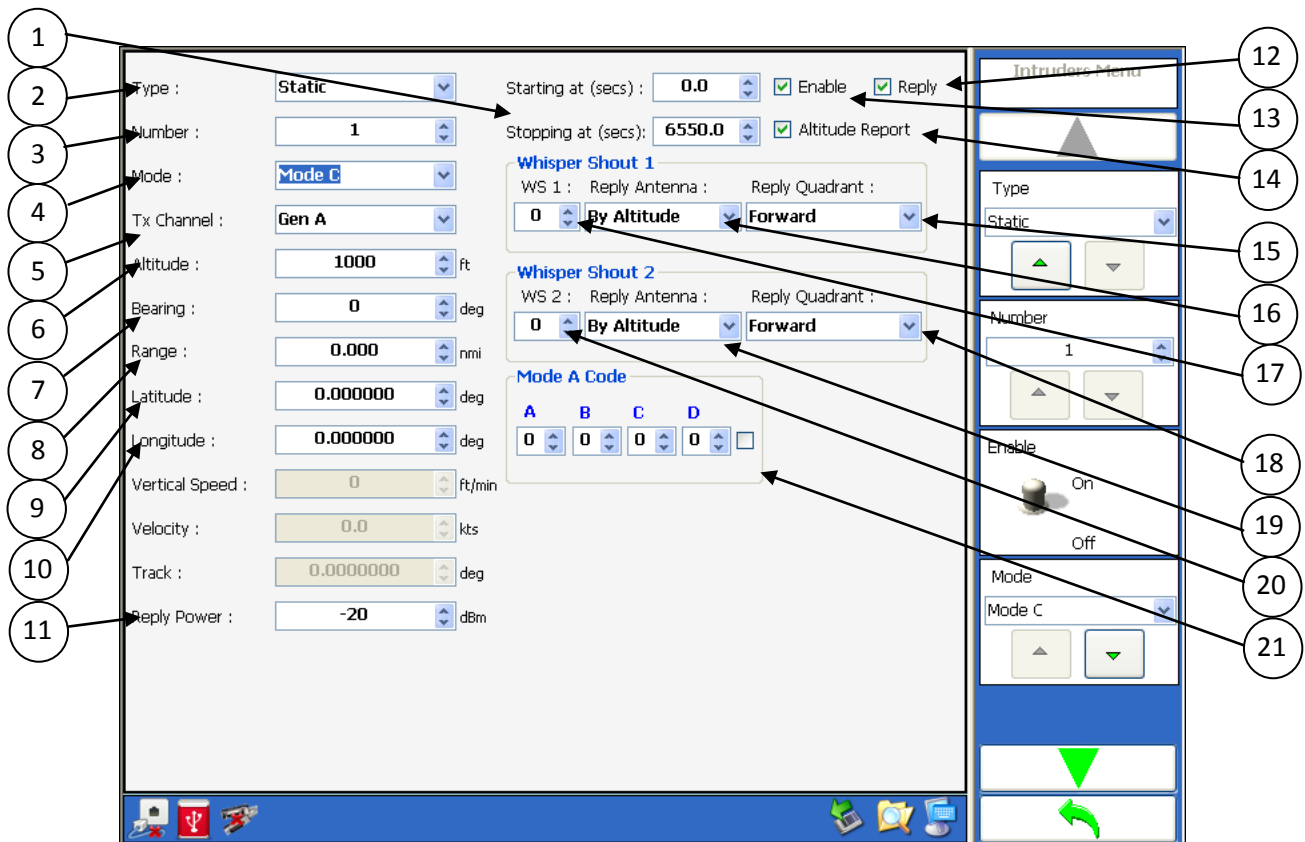

Figure 3.1.2.5.3.1 – Static Mode C Menu

Menu Control	Function
1	Start and Stop Time of the intruder.
2	Type (Dynamic or Static)
3	Number numeric box. (Dynamic: 1-32; Static: 1-400)
4	Mode combobox. (Mode S TCAS Only, Mode S Extended, Mode C, TIS-B Only)
5	Tx Channel combobox. User can select from one of three possible transmitters.
6	Altitude numeric box. Gilham range from -1000 to 126700 feet in 100 feet steps.
7	Bearing (Phase) numeric box. Range 0 – 359 degrees in 1-degree steps.

Menu Control	Function
8	Range numeric box. Range from 0 to 160 nautical miles.
9	Latitude. Range from -90 to 90 degrees.
10	Longitude. Range from -180 to 180 degrees.
11	Reply Power numeric box. Low power range -20 to -90 dBm in 1 dB steps. High power range from 1 to -69 dBm.
12	Reply checkbox.
13	Enable checkbox. If enabled then test set will transmit the required messages for this intruder.
14	Altitude Report checkbox. If enabled the altitude code pulses are transmitted with the framing pulses. If disable only the framing pulses are transmitted.
15	Reply Quadrant WS1 combobox (Forward, Right, After, Left, Any, By Location)
16	Reply Antenna WS1 combobox. (Top Only, Bottom Only, Both, By Altitude)
17	Whisper Shout Level 1
18	Reply Quadrant WS2 combobox (Forward, Right, After, Left, Any, By Location)
19	Reply Antenna WS2 combobox. (Top Only, Bottom Only, Both, By Altitude)
20	Whisper Shout Level 2
21	Mode A Code

Softkey	Function
Type	Same as menu control item 2
Number	Same as menu control item 3
Enable	Same as menu control item 13
Mode	Same as menu control item 4
Starting At	Same as menu control item 1
Stopping At	Same as menu control item 1
Reply	Same as menu control item 12
Altitude Report	Same as menu control item 14
Whisper Shout 1	Same as menu control item 17
WS1 Reply Antenna	Same as menu control item 16
WS1 Reply Quadrant	Same as menu control item 15
Whisper Shout 2	Same as menu control item 20
WS2 Reply Antenna	Same as menu control item 19
WS2 Reply Quadrant	Same as menu control item 18
Tx Channel	Same as menu control item 5
Altitude	Same as menu control item 6
Bearing	Same as menu control item 7
Range	Same as menu control item 8
Latitude	Same as menu control item 9
Longitude	Same as menu control item 10
Reply Power	Same as menu control item 11
Mode A Code (A)	Same as menu control item 21
Mode A Code (B)	Same as menu control item 21
Mode A Code (C)	Same as menu control item 21

Softkey	Function
Mode A Code (D)	Same as menu control item 21
Ident Bit	Same as menu control item 21

3.1.2.5.4. Dynamic Mode C Definition Menu

Figure 3.1.2.5.4.1 illustrates the TTG-7000 Dynamic Mode C Definition Menu. The Dynamic Mode C Definition Menu allows the user to define all the parameters for a dynamic Mode C intruder.

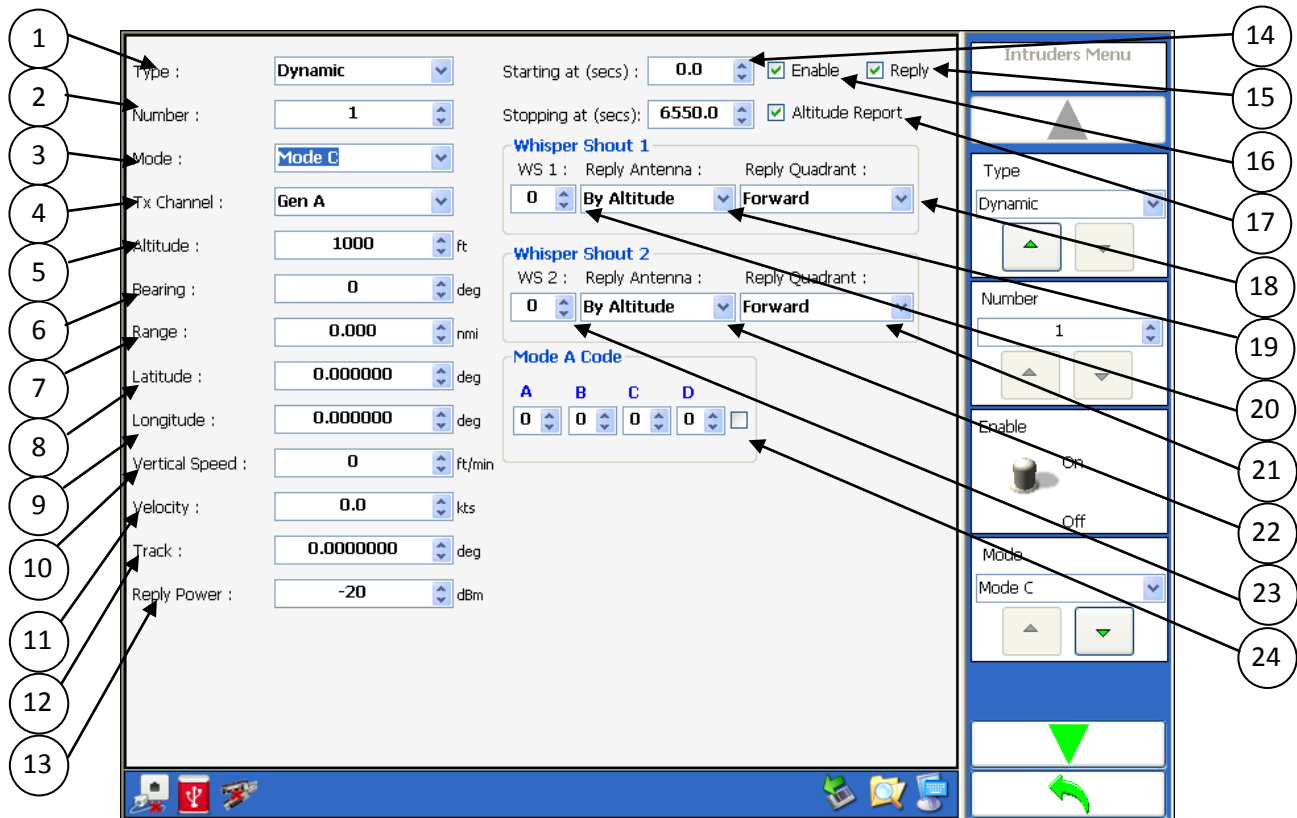

Figure 3.1.2.5.4.1 – Dynamic Mode C Menu

Menu Control	Function
1	Type combobox. (Dynamic or Static)
2	Number numeric box. (Dynamic: 1-32; Static: 1-400)
3	Mode combobox. (Mode S TCAS Only, Mode S Extended, Mode C, ADS-B Only)
4	Tx Channel combobox. User can select from one of three possible transmitters.
5	Altitude numeric box. Gilham range from -1000 to 126700 feet in 100 feet steps.
6	Bearing (Phase) numeric box. Range 0 – 359 degrees in 1-degree steps.
7	Range numeric box. Range from 0 to 160 nautical miles.
8	Latitude. Range from -90 to 90 degrees.
9	Longitude. Range from -180 to 180 degrees.

Menu Control	Function
10	Vertical Speed numeric box. Range from – 32576 to 32576 ft/min in 64 ft/min steps
11	Velocity numeric box. Range 0 to 2000 knots.
12	Track Angle numeric box. Value range from 0 to 359 degrees in 1-degree steps.
13	Reply Power numeric box. Low power range -20 to -90 dBm in 1 dB steps. High power range from 1 to -69 dBm.
14	Start and Stop Time of the intruder.
15	Reply checkbox
16	Enable checkbox. If enabled then test set will transmit the required messages for this intruder.
17	Altitude Report checkbox. If enabled the altitude code pulses are transmitted with the framing pulses. If disable only the framing pulses are transmitted.
18	Reply Quadrant WS1 combobox (Forward, Right, After, Left, Any, By Location)
19	Reply Antenna WS1 combobox. (Top Only, Bottom Only, Both, By Altitude)
20	Whisper Shout Level 1
21	Reply Quadrant WS2 combobox (Forward, Right, After, Left, Any, By Location)
22	Reply Antenna WS2 combobox. (Top Only, Bottom Only, Both, By Altitude)
23	Whisper Shout Level 2
24	Mode A Code

Softkey	Function
Type	Same as menu control item 1
Number	Same as menu control item 2
Enable	Same as menu control item 16
Mode	Same as menu control item 3
Start Time	Same as menu control item 14
Stop Time	Same as menu control item 14
Reply	Same as menu control item 15
Altitude Report	Same as menu control item 17
Whisper Shout 1	Same as menu control item 20
WS1 Reply Antenna	Same as menu control item 19
WS1 Reply Quadrant	Same as menu control item 18
Whisper Shout 2	Same as menu control item 23
WS2 Reply Antenna	Same as menu control item 22
WS2 Reply Quadrant	Same as menu control item 21
Tx Channel	Same as menu control item 4
Waypoints	Future use.
Altitude	Same as menu control item 5
Bearing	Same as menu control item 6
Range	Same as menu control item 7
Latitude	Same as menu control item 8
Longitude	Same as menu control item 9
Vertical Speed	Same as menu control item 10
Velocity	Same as menu control item 11

Softkey	Function
Track	Same as menu control item 12
Reply Power	Same as menu control item 13
Mode A Code (A)	Same as menu control item 24
Mode A Code (B)	Same as menu control item 24
Mode A Code (C)	Same as menu control item 24
Mode A Code (D)	Same as menu control item 24
Ident Bit	Same as menu control item 24

3.1.2.5.5. Static Mode S Extended Definition Menu

Figure 3.1.2.5.5.1 to 3.1.2.5.5.9 illustrates the TTG-7000 Static Mode S Extended Definition Menu. The Static Mode S Extended Definition Menu allows the user to define all the parameters for static Mode S Extended intruder.

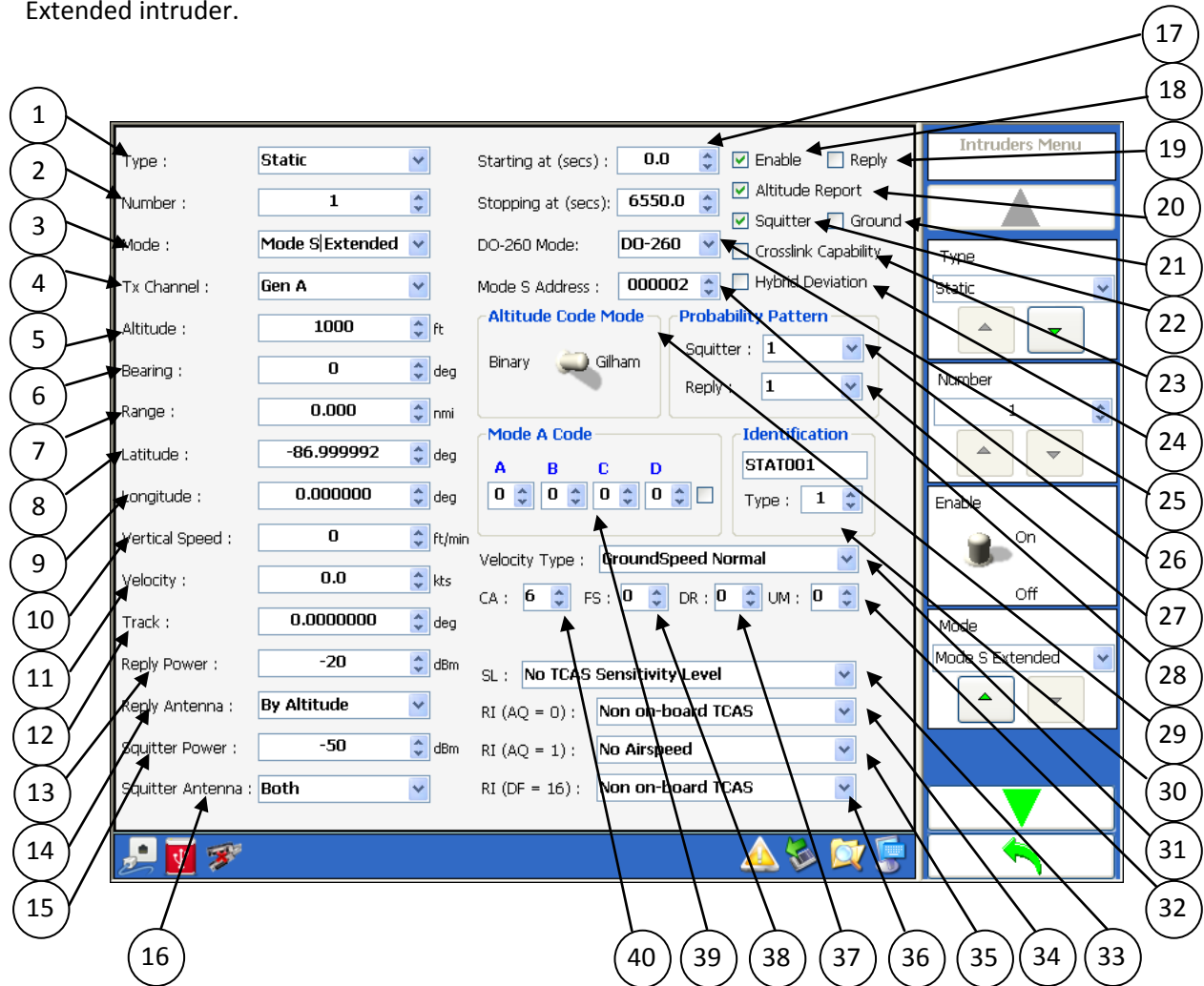

Figure 3.1.2.5.5.1 – Static Mode S Extended Menu

Menu Control	Function
1	Type combobox. (Dynamic or Static)
2	Number numeric box. (Dynamic: 1-32; Static: 1-400)
3	Mode combobox. (Mode S TCAS Only, Mode S Extended, Mode C, TIS-B, ADS-R)

Menu Control	Function
4	Tx Channel combobox. User can select from one of three possible transmitters.
5	Altitude numeric box. Binary range from -1000 to 50175 feet in 25 feet steps. Gilham range from -1000 to 126700 feet in 100 feet steps.
6	Bearing (Phase) numeric box. Range 0 – 359 degrees in 1-degree steps.
7	Range numeric box. Range from 0 to 160 nautical miles.
8	Latitude. Range from -90 to 90 degrees
9	Longitude. Range from -180 to 180 degrees.
10	Vertical Speed numeric box. Range from – 32576 to 32576 ft/min in 64 ft/min steps. Used only for the velocity squitter, since the intruder is static.
11	Velocity numeric box. Range 0 to 2000 knots. Used only for the velocity squitter, since the intruder is static.
12	Track Angle numeric box. Value range from -180 to 180 degrees in 1-degree steps. Used only for the velocity squitter, since the intruder is static.
13	Reply Power numeric box. Low power range -20 to -90 dBm in 1 dB steps. High power range from 1 to -69 dBm.
14	Reply Antenna combobox. (Top Only, Bottom Only, Alternating, Both, By Altitude)
15	Squitter Power numeric box. Low power range -20 to -90 dBm in 1 dB steps. High power range from 1 to -69 dBm.
16	Squitter Antenna combobox. (Top Only, Bottom Only, Both)
17	Start/Stop Time. Time intruder is active.
18	Enable checkbox. If checked then test set will transmit the required messages for this intruder.
19	Reply checkbox. If checked then the intruder will reply to interrogations.
20	Altitude Report checkbox. If enabled the altitude code will be present in the DF0 reply. If disabled the altitude code will set to 0.
21	Ground checkbox allows the user to set VS bit for the intruder.
22	Squitter checkbox. If enabled squitter are active.
23	Crosslink Capability checkbox.
24	Hybrid Deviation checkbox. If enabled allows deviation in altitude, bearing, and range.
25	DO-260 Mode. (Version -, A, or B).
26	Squitter Probability Pattern combobox. (Values: 1.0, 0.8, 0.6, 0.4, 0.2)
27	Reply Probability Pattern combobox. (Values: 1.0, 0.8, 0.6, 0.4, 0.2)
28	Mode S Address numeric box.
29	Altitude Mode switch. (Gilham or Binary)
30	Identification Type and Intruder Identification.
31	Velocity Type
32	Utility Message (UM)
33	SL combobox
34	RI (AQ = 0) combobox
35	RI (AQ = 1) combobox
36	RI (DF=16)
37	Downlink Message (DR)
38	Flight Status (FS)
39	Mode A Code

Menu Control	Function
40	CA Field

Softkey	Function
Type	Same as menu control item 1
Number	Same as menu control item 2
Enable	Same as menu control item 18
Mode	Same as menu control item 3
Starting At	Same as menu control item 17
Stopping At	Same as menu control item 17
Reply	Same as menu control item 19
Squitter	Same as menu control item 22
Altitude Report	Same as menu control item 20
Ground	Same as menu control item 21
Crosslink Capability	Same as menu control item 23
DO-260 Mode	Same as menu control item 25
Mode S Address	Same as menu control item 28
Hybrid Deviation	Same as menu control item 24
Hybrid Deviation Values	
Tx Channel	Same as menu control item 4
CPR Encoding	Odd/Even, Odd, or Even
Mode S Squitters	
Coordination Message Definition	
Broadcast Message Definition	
DF16 Reply Message Menu	
UF0 Message Menu	
Ident Format Type	Same as menu control item 30
Altitude Mode	Same as menu control item 29
Altitude	Same as menu control item 5
Bearing	Same as menu control item 6
Range	Same as menu control item 7
Latitude	Same as menu control item 8
Longitude	Same as menu control item 9
Velocity Type	Same as menu control item 31
Vertical Speed	Same as menu control item 10
Velocity	Same as menu control item 11
Track	Same as menu control item 12
Reply Power	Same as menu control item 13
Reply Antenna	Same as menu control item 14
Squitter Power	Same as menu control item 15
Squitter Antenna	Same as menu control item 16
Squitter Probability Pattern	Same as menu control item 26
Reply Probability Pattern	Same as menu control item 27
Mode A Code (A)	Same as menu control item 39

Softkey	Function
Mode A Code (B)	Same as menu control item 39
Mode A Code (C)	Same as menu control item 39
Mode A Code (D)	Same as menu control item 39
Ident Bit	Same as menu control item 39
Transponder Capability (CA) Field	Same as menu control item 40
Flight Status (FS)	Same as menu control item 38
Downlink Request (DR)	Same as menu control item 37
Utility Message (UM)	Same as menu control item 32
Sensitivity Level	Same as menu control item 33
RI (AQ=0)	Same as menu control item 34
RI (AQ=1)	Same as menu control item 35
RI (DF=16)	Same as menu control item 36

3.1.2.5.5.1. Mode S Squitter Definition

Figure 3.1.2.5.5.1 illustrates the TTG-7000 Mode S Squitter Definition Menu. The Mode S Squitter Definition Menu allows the user to define all the parameters for a Mode S ADS-B intruder.



Figure 3.1.2.5.5.1 – Mode S Squitter Definition Menu

Menu Control	Function
1	Data Grid of the current defined squitters

Softkey	Function
ME Field →	Opens specific squitter definition menu
	Position Squitter Velocity Squitter Ident Squitter
BDS Register Number Menu	

3.1.2.5.5.2. Position Squitter Definition Menu

Figure 3.1.2.5.5.2.1 illustrates the TTG-7000 Position Squitter Definition Menu. The Position Squitter Definition Menu allows the user to define all the parameters for a position squitter.

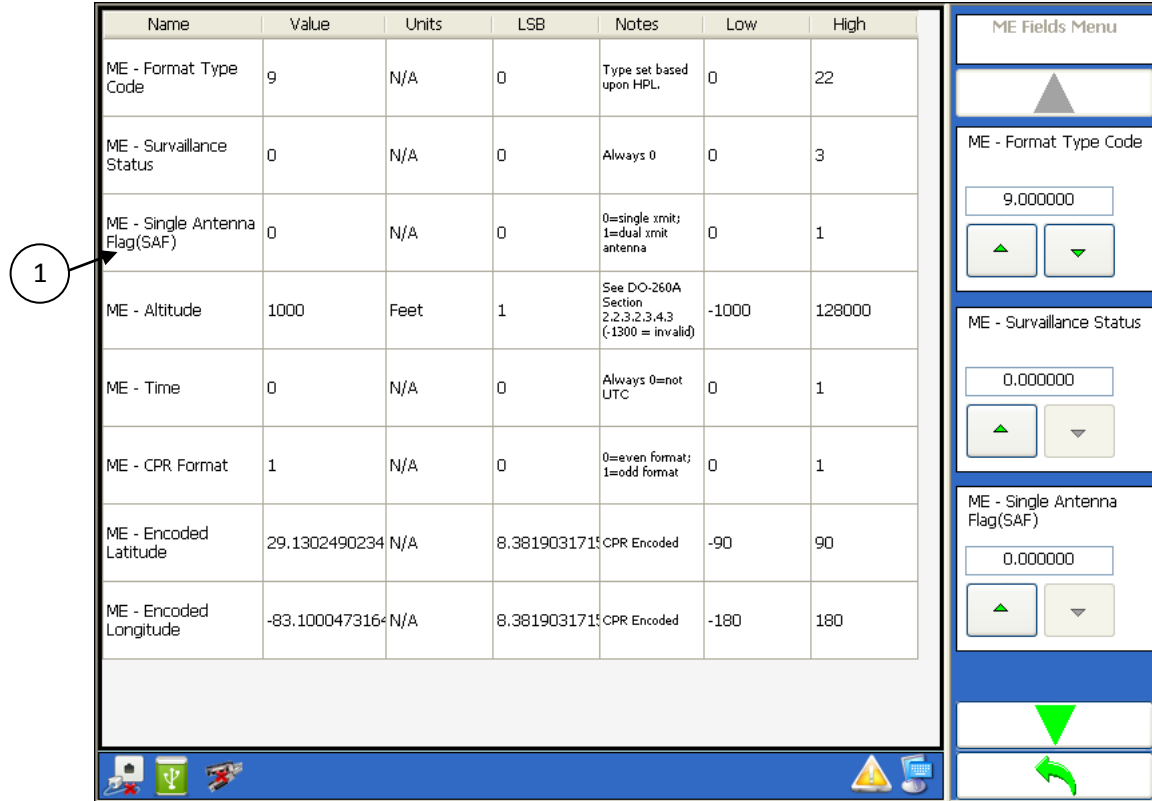

Figure 3.1.2.5.5.2.1 – Position Squitter Definition Menu

Menu Control	Function
1	Breakdown of the Position Squitter

Softkey	Function
Format Type Code	
Surveillance Status	
Single Antenna Flag	
Altitude	Allows setting invalid/no data.
Time Bit	
CPR Format	
Latitude	
Longitude	

3.1.2.5.5.3. Velocity Squitter Definition Menu

Figure 3.1.2.5.5.3.1 illustrates the TTG-7000 Velocity Squitter Definition Menu. The Velocity Squitter Definition Menu allows the user to define all the parameters for a velocity squitter.



Figure 3.1.2.5.5.3.1 – Velocity Squitter Definition Menu

Menu Control	Function
1	Breakdown of the Velocity Squitter

Softkey	Function
Format Type Code	
Sub Type	
Intent Change Flag	
IFR Capability Flag	
Navigation Accuracy	
East/West Direction	
East/West Velocity	Allows setting invalid/no data.
North/South Direction	

Softkey	Function
North/South Velocity	Allows setting invalid/no data.
Source Bit	
Sign Bit	
Vertical Rate	Allows setting invalid/no data.
Difference Sign Bit	
Geometric Height Difference	Allows setting invalid/no data.

3.1.2.5.5.4. Ident Squitter Definition Menu

Figure 3.1.2.5.5.4.1 illustrates the TTG-7000 Identification Squitter Definition Menu. The Identification Squitter Definition Menu allows the user to define all the parameters for an Ident squitter.

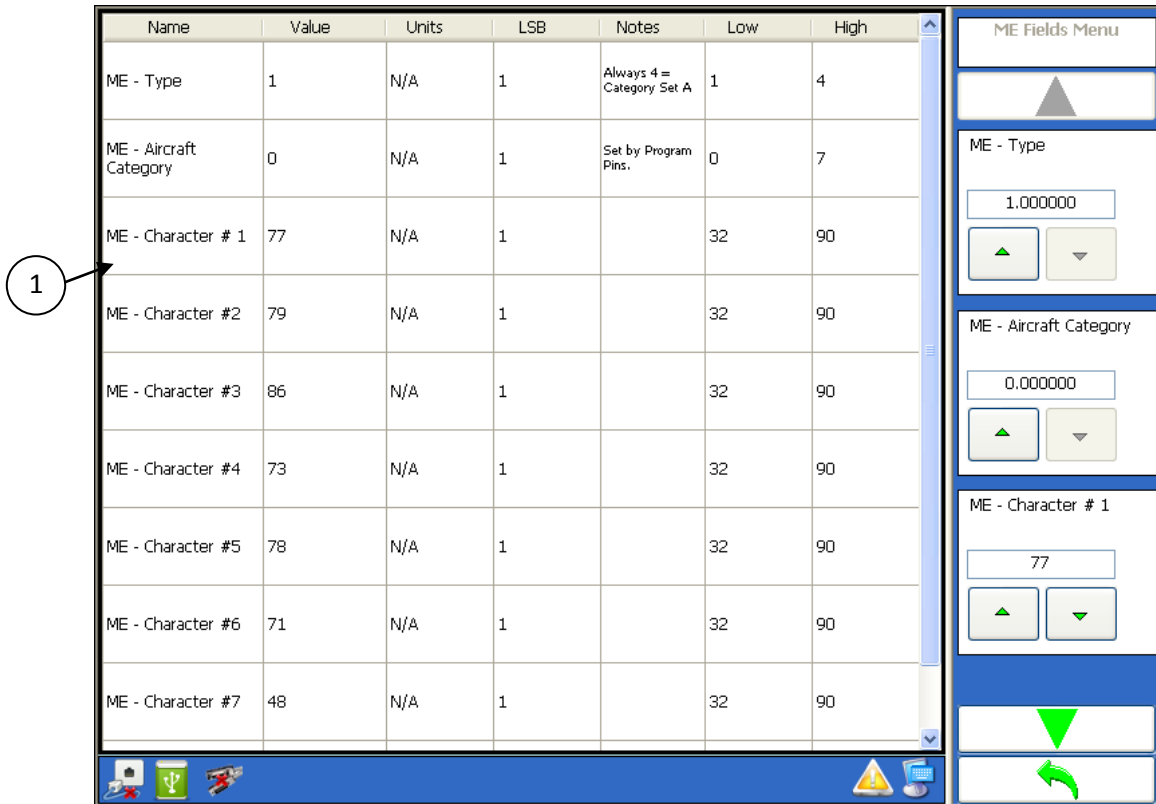

Figure 3.1.2.5.5.4.1 – Ident Squitter Definition Menu

Menu Control	Function
1	Breakdown of the Ident Squitter

Softkey	Function
Type	
Aircraft Category	
Character #1	
Character #2	
Character #3	
Character #4	

Softkey	Function
Character #5	
Character #6	
Character #7	
Character #8	

3.1.2.5.5.5. BDS Register Definition Menu

Figure 3.1.2.5.5.5.1 illustrates the TTG-7000 BDS Register Definition Menu. The BDS Register Definition Menu allows the user to add or remove BDS registers to a Mode S Extended intruder.

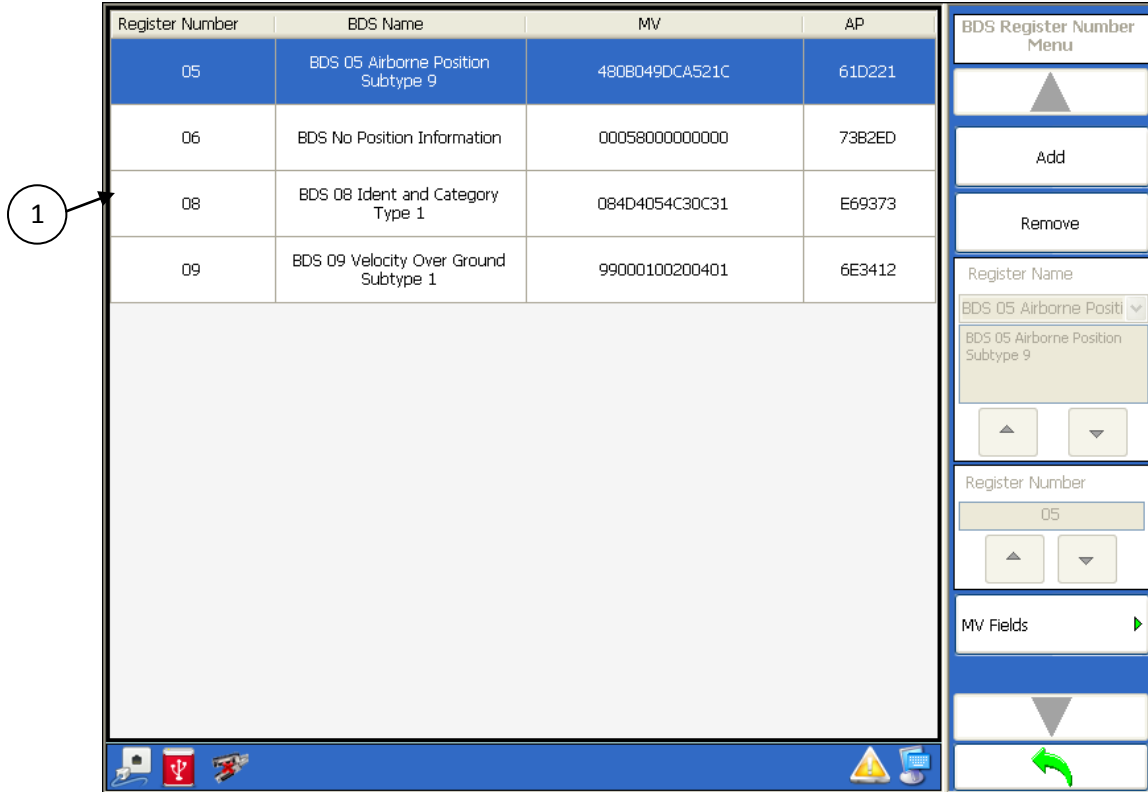

Figure 3.1.2.5.5.5.1 – Ident Squitter Definition Menu

Menu Control	Function
1	Data grid of all defined BDS registers

Softkey	Function
Add	
Remove	
MV Field Menu	

3.1.2.5.6. Dynamic Mode S Extended Definition Menu

Figure 3.1.2.5.6.1 illustrates the TTG-7000 Dynamic Mode S Extended Definition Menu. The Static Mode S Extended Definition Menu allows the user to define all the parameters for a dynamic Mode S Extended intruder.

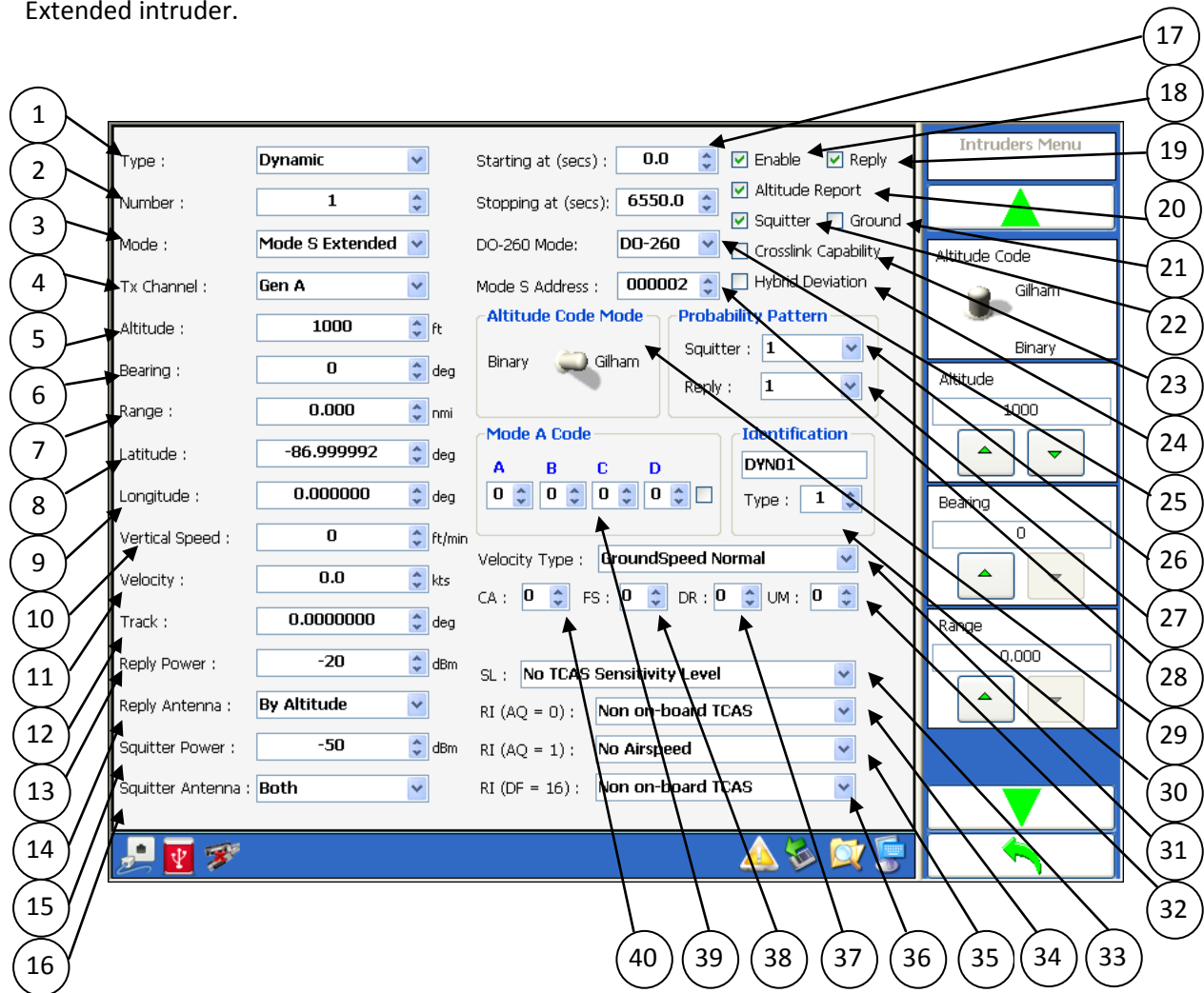

Figure 3.1.2.5.6.1 – Dynamic Mode S Extended Menu

Menu Control	Function
1	Type combobox. (Dynamic or Static)
2	Number numeric box. (Dynamic: 1-32; Static: 1-400)
3	Mode combobox. (Mode S TCAS Only, Mode S Extended, Mode C, TIS-B, ADS-R)
4	Tx Channel combobox. User can select from one of three possible transmitters.

Menu Control	Function
5	Altitude numeric box. Binary range from -1000 to 50175 feet in 25 feet steps. Gilham range from -1000 to 126700 feet in 100 feet steps.
6	Bearing (Phase) numeric box. Range 0 – 359 degrees in 1-degree steps.
7	Range numeric box. Range from 0 to 160 nautical miles.
8	Latitude. Range from -90 to 90 degrees
9	Longitude. Range from -180 to 180 degrees.
10	Vertical Speed numeric box. Range from – 32576 to 32576 ft/min in 64 ft/min steps.
11	Velocity numeric box. Range 0 to 2000 knots.
12	Track Angle numeric box. Value range from -180 to 180 degrees in 1-degree steps.
13	Reply Power numeric box. Low power range -20 to -90 dBm in 1 dB steps. High power range from 1 to -69 dBm.
14	Reply Antenna combobox. (Top Only, Bottom Only, Alternating, Both, By Altitude)
15	Squitter Power numeric box. Low power range -20 to -90 dBm in 1 dB steps. High power range from 1 to -69 dBm.
16	Squitter Antenna combobox. (Top Only, Bottom Only, Both)
17	Start/Stop Time. Time intruder is active.
18	Reply checkbox. If checked then the intruder will reply to interrogations.
19	Enable. If checked then test set will transmit the required messages for this intruder.
20	Altitude Report checkbox. If enabled the altitude code will be present in the DF0 reply. If disabled the altitude code will set to 0.
21	Ground checkbox allows the user to set VS bit for the intruder.
22	Squitter checkbox. If enabled squitter are active.
23	Crosslink Capability checkbox.
24	Override Range Calculation checkbox.
25	DO-260 Mode. (Version -, A, or B).
26	Squitter Probability Pattern combobox. (Values: 1.0, 0.8, 0.6, 0.4, 0.2)
27	Reply Probability Pattern combobox. (Values: 1.0, 0.8, 0.6, 0.4, 0.2)
28	Mode S Address numeric box.
29	Altitude Mode switch. (Gilham or Binary)
30	Identification Type and Intruder Identification.
31	Velocity Type
32	Utility Message (UM)
33	SL combobox
34	RI (AQ = 0) combobox
35	RI (AQ = 1) combobox
36	RI (DF=16)
37	Downlink Message (DR)
38	Flight Status (FS)
39	Mode A Code
40	CA Field

Softkey	Function
Type	Same as menu control item 1

Softkey	Function
Number	Same as menu control item 2
Enable	Same as menu control item 19
Mode	Same as menu control item 3
Starting At	Same as menu control item 17
Stopping At	Same as menu control item 17
Reply	Same as menu control item 18
Squitter	Same as menu control item 22
Altitude Report	Same as menu control item 20
Ground	Same as menu control item 21
Crosslink Capability	Same as menu control item 23
DO-260 Mode	Same as menu control item 25
Mode S Address	Same as menu control item 28
Hybrid Deviation	Same as menu control item 24
Hybrid Deviation Values	
Tx Channel	Same as menu control item 4
CPR Encoding	Odd/Even, Odd or Even
Mode S Squitters	
Coordination Message Definition	
Broadcast Message Definition	
DF16 Reply Message Menu	
UF0 Message Menu	
Waypoints	
Ident Format Type	Same as menu control item 30
Altitude Mode	Same as menu control item 29
Altitude	Same as menu control item 5
Bearing	Same as menu control item 6
Range	Same as menu control item 7
Latitude	Same as menu control item 8
Longitude	Same as menu control item 9
Velocity Type	Same as menu control item 31
Vertical Speed	Same as menu control item 10
Velocity	Same as menu control item 11
Track	Same as menu control item 12
Reply Power	Same as menu control item 13
Reply Antenna	Same as menu control item 14
Squitter Power	Same as menu control item 15
Squitter Antenna	Same as menu control item 16
Squitter Probability Pattern	Same as menu control item 26
Reply Probability Pattern	Same as menu control item 27
Mode A Code (A)	Same as menu control item 39
Mode A Code (B)	Same as menu control item 39
Mode A Code (C)	Same as menu control item 39
Mode A Code (D)	Same as menu control item 39
Ident Bit	Same as menu control item 39

Softkey	Function
Transponder Capability (CA) Field	Same as menu control item 40
Flight Status (FS)	Same as menu control item 38
Downlink Request (DR)	Same as menu control item 37
Utility Message (UM)	Same as menu control item 32
Sensitivity Level	Same as menu control item 33
RI (AQ=0)	Same as menu control item 34
RI (AQ=1)	Same as menu control item 35
RI (DF=16)	Same as menu control item 36

3.1.2.5.7. Static TIS-B Definition Menu

Figure 3.1.2.5.7.1 illustrates the TTG-7000 Static TIS-B Definition Menu. The Static TIS-B Definition Menu allows the user to define all the parameters for static TIS-B (DF18) intruder.

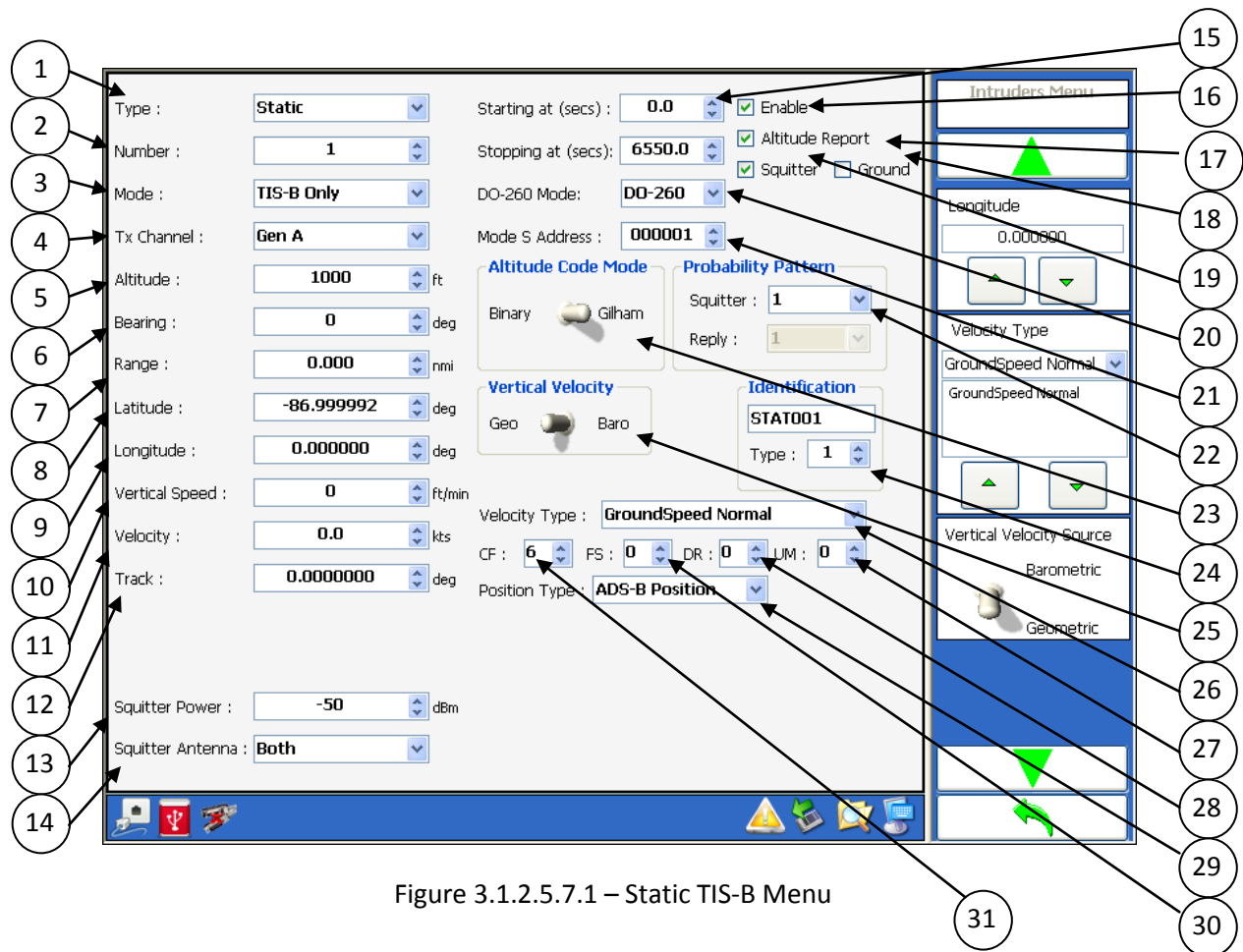

Figure 3.1.2.5.7.1 – Static TIS-B Menu

Menu Control	Function
1	Type combobox. (Dynamic or Static)
2	Number numeric box. (Dynamic: 1-32; Static: 1-400)
3	Mode combobox. (Mode S TCAS Only, Mode S Extended, Mode C, TIS-B, ADS-R)
4	Tx Channel combobox. User can select from one of three possible transmitters.
5	Altitude numeric box. Binary range from -1000 to 50175 feet in 25 feet steps. Gilham range from -1000 to 126700 feet in 100 feet steps.
6	Bearing (Phase) numeric box. Range 0 – 359 degrees in 1-degree steps.
7	Range numeric box. Range from 0 to 160 nautical miles.

Menu Control	Function
8	Latitude. Range from -90 to 90 degrees.
9	Longitude. Range from -180 to 180 degrees.
10	Vertical Speed numeric box. Range from – 32576 to 32576 ft/min in 64 ft/min steps. Used only for the velocity squitter, since the intruder is static.
11	Velocity numeric box. Range 0 to 2000 knots. Used only for the velocity squitter, since the intruder is static.
12	Track Angle numeric box. Value range from -180 to 180 degrees in 1-degree steps. Used only for the velocity squitter, since the intruder is static.
13	Squitter Power numeric box. Low power range -20 to -90 dBm in 1 dB steps. High power range from 1 to -69 dBm.
14	Squitter Antenna combobox. (Top Only, Bottom Only, Both)
15	Start/Stop Time.
16	Enable. If checked then test set will transmit the required messages for this intruder.
17	Altitude Report checkbox. If enabled the altitude code will be present in the DF0 reply. If disabled the altitude code will set to 0.
18	Ground checkbox allows the user to set VS bit for the intruder.
19	Squitter checkbox. If enabled squitter are active.
20	DO-260 Mode. (Version -, A, or B).
21	Mode S Address numeric box.
22	Squitter Probability Pattern combobox. (Values: 1.0, 0.8, 0.6, 0.4, 0.2)
23	Altitude Mode switch. (Gilham or Binary)
24	Intruder Identification
25	Vertical Velocity
26	Velocity Type
27	Utility Message (UM) Field
28	Downlink Request (DR) Field
29	Position Type combobox (ADS-B, Fine, or Coarse).
30	Flight Status (FS) Field
31	Transponder Capability (CF) Field

Softkey	Function
Type	Same as menu control item 1
Number	Same as menu control item 2
Enable	Same as menu control item 16
Mode	Same as menu control item 3
Starting At	Same as menu control item 15
Stopping At	Same as menu control item 15
Squitter	Same as menu control item 19
Altitude Report	Same as menu control item 17
Ground	Same as menu control item 18
DO-260 Mode	Same as menu control item 20
Mode S Address	Same as menu control item 21
Tx Channel	Same as menu control item 4

Softkey	Function
CPR Encoding	Odd/Even, Odd, or Even
Mode S Squitter Menu	
Ident Format Type	Same as menu control item 24
Altitude Code	Same as menu control item 23
Altitude	Same as menu control item 5
Bearing	Same as menu control item 6
Range	Same as menu control item 7
Latitude	Same as menu control item 8
Longitude	Same as menu control item 9
Velocity Type	Same as menu control item 26
Vertical Velocity Source	Same as menu control item 25
Vertical Speed	Same as menu control item 10
Velocity	Same as menu control item 11
Track	Same as menu control item 12
Squitter Power	Same as menu control item 13
Squitter Antenna	Same as menu control item 14
Squitter Probability Pattern	Same as menu control item 22
Transponder Capability (CA) Field	Same as menu control item 31
Position Type	Same as menu control item 29
Flight Status (FS) Field	Same as menu control item 30
Downlink Request (DR) Field	Same as menu control item 28
Utility Message (UM) Field	Same as menu control item 27

3.1.2.5.8. Dynamic TIS-B Definition Menu

Figure 3.1.2.5.8.1 illustrates the TTG-7000 Dynamic TIS-B Only Definition Menu. The Dynamic TIS-B Definition Menu allows the user to define all the parameters for a dynamic TIS-B (DF18) intruder.

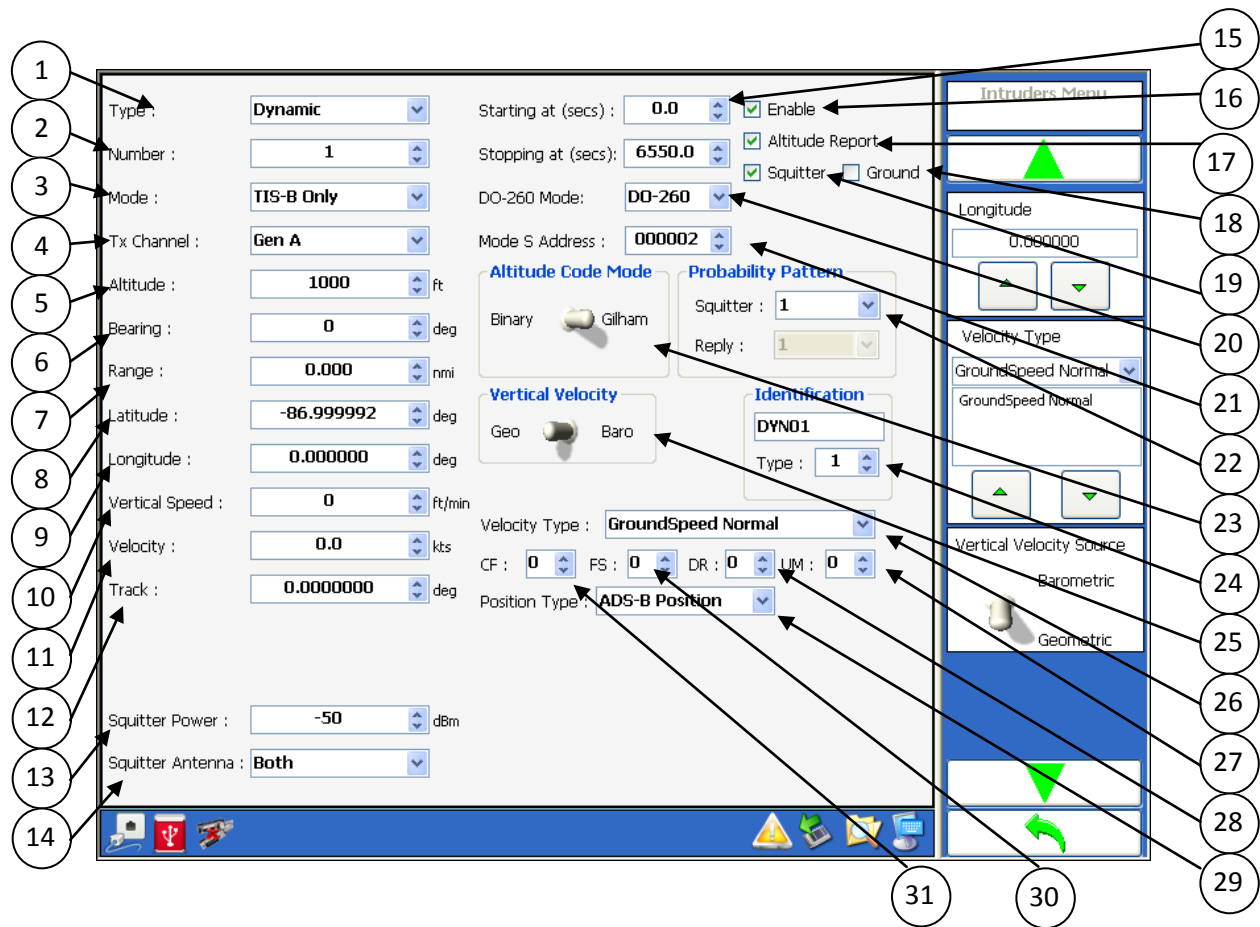

Figure 3.1.2.5.8.1 – Dynamic TIS-B Menu

Menu Control	Function
1	Type combobox. (Dynamic or Static)
2	Number numeric box. (Dynamic: 1-32; Static: 1-400)
3	Mode combobox. (Mode S TCAS Only, Mode S Extended, Mode C, TIS-B, ADS-R)
4	Tx Channel combobox. User can select from one of three possible transmitters.
5	Altitude numeric box. Binary range from -1000 to 50175 feet in 25 feet steps. Gilham range from -1000 to 126700 feet in 100 feet steps.
6	Bearing (Phase) numeric box. Range 0 – 359 degrees in 1-degree steps.
7	Range numeric box. Range from 0 to 160 nautical miles.

Menu Control	Function
8	Latitude. Range from -90 to 90 degrees.
9	Longitude. Range from -180 to 180 degrees.
10	Vertical Speed numeric box. Range from – 32576 to 32576 ft/min in 64 ft/min steps.
11	Velocity numeric box. Range 0 to 2000 knots.
12	Track Angle numeric box. Value range from -180 to 180 degrees in 1-degree steps.
13	Squitter Power numeric box. Low power range -20 to -90 dBm in 1 dB steps. High power range from 1 to -69 dBm.
14	Squitter Antenna combobox. (Top Only, Bottom Only, Both)
15	Start/Stop Time.
16	Enable. If checked then test set will transmit the required messages for this intruder.
17	Altitude Report checkbox. If enabled the altitude code will be present in the DF0 reply. If disabled the altitude code will set to 0.
18	Ground checkbox allows the user to set VS bit for the intruder.
19	Squitter Enable.
20	DO-260 Mode (-,A, or B).
21	Mode S Address numeric box.
22	Squitter Probability Pattern combobox. (Values: 1.0, 0.8, 0.6, 0.4, 0.2)
23	Altitude Code switch. (Gilham or Binary)
24	Intruder Identification
25	Vertical Velocity Source (Geometric or Barometric)
26	Velocity Type
27	Utility Message (UM) Field
28	Downlink Request (DR) Field
29	Position Squitter Type (ADS-B, Fine or Coarse)
30	Flight Status (FS) Field
31	Transponder Capability (CA) Field

Softkey	Function
Type	Same as menu control item 1
Number	Same as menu control item 2
Enable	Same as menu control item 16
Mode	Same as menu control item 3
Starting At	Same as menu control item 15
Stopping At	Same as menu control item 15
Squitter	Same as menu control item 19
Altitude Report	Same as menu control item 17
Ground	Same as menu control item 18
DO-260 Mode	Same as menu control item 20
Mode S Address	Same as menu control item 21
Tx Channel	Same as menu control item 4
CPR Encoding	Odd/Even, Odd, or Even
Mode S Squitter Menu	
Waypoints	

Softkey	Function
Ident Format Type	Same as menu control item 24
Altitude Code	Same as menu control item 23
Altitude	Same as menu control item 5
Bearing	Same as menu control item 6
Range	Same as menu control item 7
Latitude	Same as menu control item 8
Longitude	Same as menu control item 9
Velocity Type	Same as menu control item 26
Vertical Speed	Same as menu control item 10
Velocity	Same as menu control item 11
Track	Same as menu control item 12
Squitter Power	Same as menu control item 13
Squitter Antenna	Same as menu control item 14
Squitter Probability Pattern	Same as menu control item 22
Transponder Capability (CA) Field	Same as menu control item 31
Position Type	Same as menu control item 29
Flight Status (FS) Field	Same as menu control item 30
Downlink Request (DR) Field	Same as menu control item 28
Utility Message (UM) Field	Same as menu control item 27

3.1.2.5.9. Static ADS-R Definition Menu

Figure 3.1.2.5.9.1 illustrates the TTG-7000 Static ADS-R Definition Menu. The Static ADS-R Definition Menu allows the user to define all the parameters for static ADS-R (DF18) intruder.

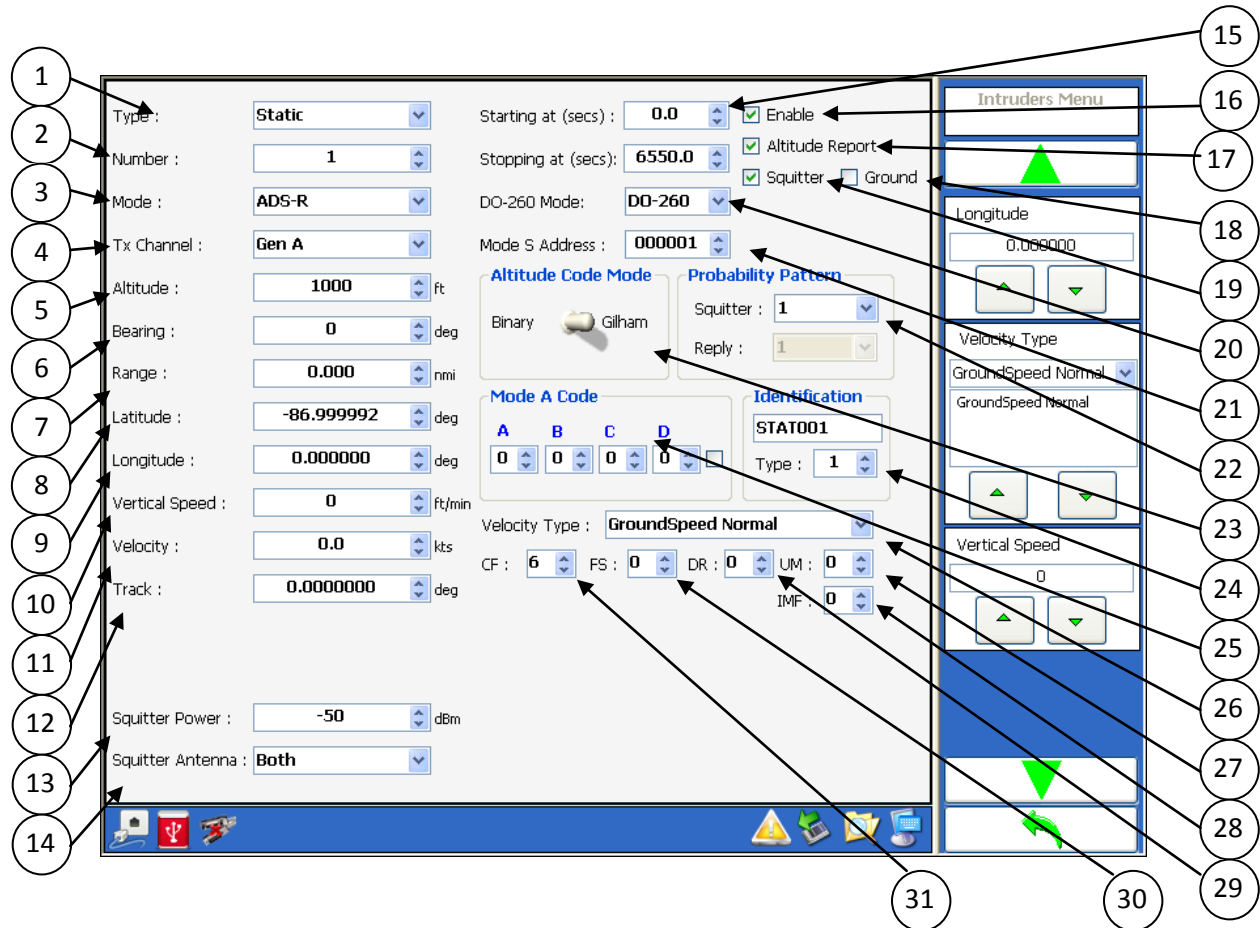

Figure 3.1.2.5.9.1 – Static ADS-R Menu

Menu Control	Function
1	Type combobox. (Dynamic or Static)
2	Number numeric box. (Dynamic: 1-32; Static: 1-400)
3	Mode combobox. (Mode S TCAS Only, Mode S Extended, Mode C, TIS-B, ADS-R)
4	Tx Channel combobox. User can select from one of three possible transmitters.
5	Altitude numeric box. Binary range from -1000 to 50175 feet in 25 feet steps. Gilham range from -1000 to 126700 feet in 100 feet steps.
6	Bearing (Phase) numeric box. Range 0 – 359 degrees in 1-degree steps.
7	Range numeric box. Range from 0 to 160 nautical miles.

Menu Control	Function
8	Latitude. Range from -90 to 90 degrees.
9	Longitude. Range from -180 to 180 degrees.
10	Vertical Speed numeric box. Range from – 32576 to 32576 ft/min in 64 ft/min steps.
11	Velocity numeric box. Range 0 to 2000 knots.
12	Track Angle numeric box. Value range from -180 to 180 degrees in 1-degree steps.
13	Squitter Power numeric box. Low power range -20 to -90 dBm in 1 dB steps. High power range from 1 to -69 dBm.
14	Squitter Antenna combobox. (Top Only, Bottom Only, Both)
15	Start/Stop Time.
16	Enable. If checked then test set will transmit the required messages for this intruder.
17	Altitude Report checkbox. If enabled the altitude code will be present in the DF0 reply. If disabled the altitude code will set to 0.
18	Ground checkbox allows the user to set VS bit for the intruder.
19	Squitter Enable.
20	DO-260 Mode (-, A, or B).
21	Mode S Address numeric box.
22	Squitter Probability Pattern combobox. (Values: 1.0, 0.8, 0.6, 0.4, 0.2)
23	Altitude Code switch. (Gilham or Binary)
24	Intruder Identification
25	Mode A Code
26	Velocity Type
27	Utility Message (UM) Field
28	IMF Field
29	Downlink Request (DR) Field
30	Flight Status (FS) Field
31	Transponder Capability (CA) Field

Softkey	Function
Type	Same as menu control item 1
Number	Same as menu control item 2
Enable	Same as menu control item 16
Mode	Same as menu control item 3
Starting At	Same as menu control item 15
Stopping At	Same as menu control item 15
Squitter	Same as menu control item 19
Altitude Report	Same as menu control item 17
Ground	Same as menu control item 18
DO-260 Mode	Same as menu control item 20
Mode S Address	Same as menu control item 21
Tx Channel	Same as menu control item 4
CPR Encoding	Odd/Even, Odd, or Even
Mode S Squitter Menu	
Ident Format Type	Same as menu control item 24

Softkey	Function
Altitude Code	Same as menu control item 23
Altitude	Same as menu control item 5
Bearing	Same as menu control item 6
Range	Same as menu control item 7
Latitude	Same as menu control item 8
Longitude	Same as menu control item 9
Velocity Type	Same as menu control item 26
Vertical Speed	Same as menu control item 10
Velocity	Same as menu control item 11
Track	Same as menu control item 12
Squitter Power	Same as menu control item 13
Squitter Antenna	Same as menu control item 14
Squitter Probability Pattern	Same as menu control item 22
Mode A – A	Same as menu control item 25
Mode A – B	Same as menu control item 25
Mode A – C	Same as menu control item 25
Mode A – D	Same as menu control item 25
Mode A Ident	Same as menu control item 25
Transponder Capability (CA) Field	Same as menu control item 31
IMF	Same as menu control item 28
Flight Status (FS) Field	Same as menu control item 30
Downlink Request (DR) Field	Same as menu control item 29
Utility Message (UM) Field	Same as menu control item 27

3.1.2.5.10. Dynamic ADS-R Definition Menu

Figure 3.1.2.5.10.1 illustrates the TTG-7000 Dynamic ADS-R Definition Menu. The Dynamic ADS-R Definition Menu allows the user to define all the parameters for a dynamic ADS-R (DF18) intruder.

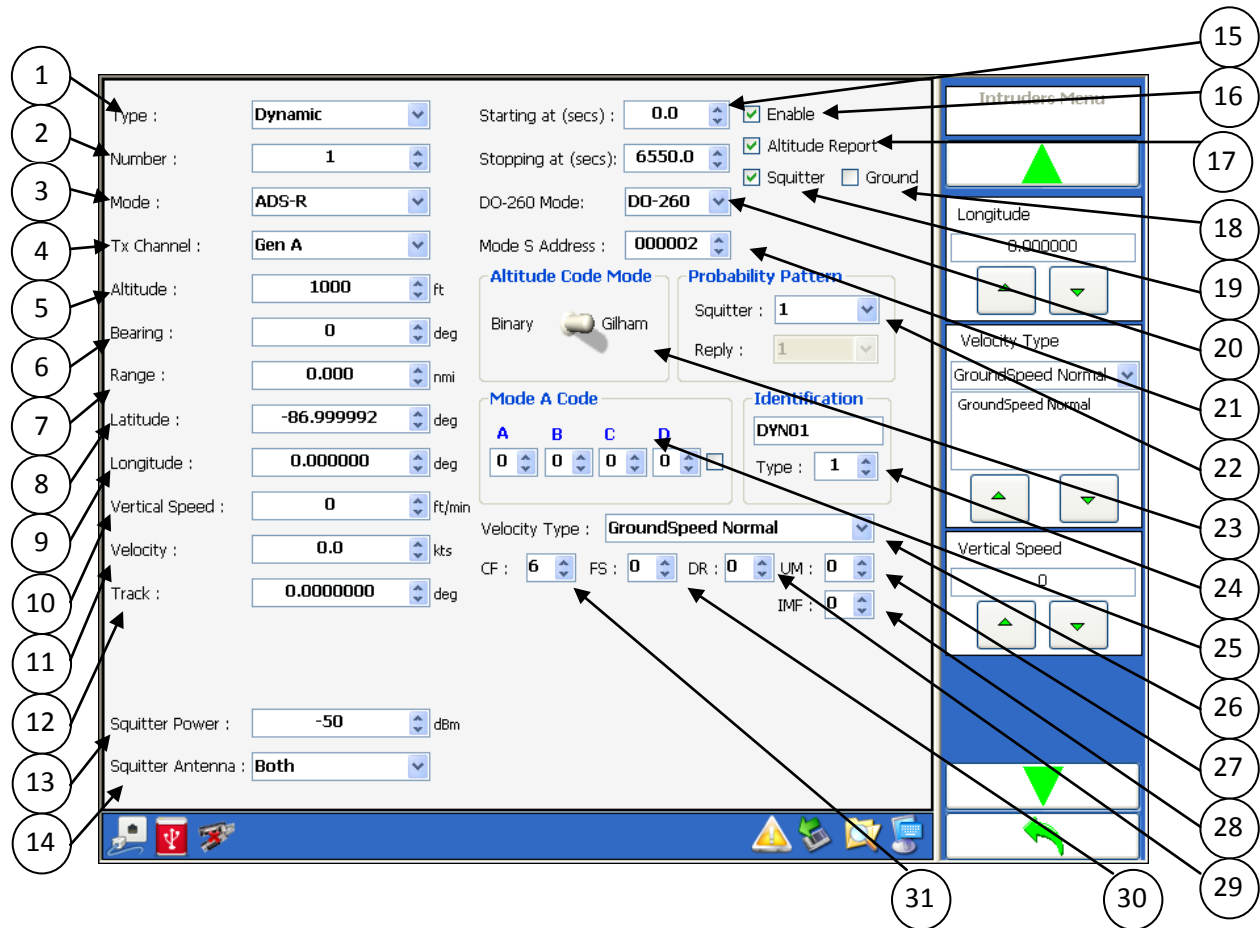

Figure 3.1.2.5.10.1 – Dynamic ADS-R Menu

Menu Control	Function
1	Type combobox. (Dynamic or Static)
2	Number numeric box. (Dynamic: 1-32; Static: 1-400)
3	Mode combobox. (Mode S TCAS Only, Mode S Extended, Mode C, TIS-B, ADS-R)
4	Tx Channel combobox. User can select from one of three possible transmitters.
5	Altitude numeric box. Binary range from -1000 to 50175 feet in 25 feet steps. Gilham range from -1000 to 126700 feet in 100 feet steps.
6	Bearing (Phase) numeric box. Range 0 – 359 degrees in 1-degree steps.
7	Range numeric box. Range from 0 to 160 nautical miles.
8	Latitude. Range from -90 to 90 degrees.
9	Longitude. Range from -180 to 180 degrees.

Menu Control	Function
10	Vertical Speed numeric box. Range from – 32576 to 32576 ft/min in 64 ft/min steps.
11	Velocity numeric box. Range 0 to 2000 knots.
12	Track Angle numeric box. Value range from -180 to 180 degrees in 1-degree steps.
13	Squitter Power numeric box. Low power range -20 to -90 dBm in 1 dB steps. High power range from 1 to -69 dBm.
14	Squitter Antenna combobox. (Top Only, Bottom Only, Both)
15	Start/Stop Time.
16	Enable. If checked then test set will transmit the required messages for this intruder.
17	Altitude Report checkbox. If enabled the altitude code will be present in the DF0 reply. If disabled the altitude code will set to 0.
18	Ground checkbox allows the user to set VS bit for the intruder.
19	Squitter Enable.
20	DO-260 Mode (-,A, or B).
21	Mode S Address numeric box.
22	Squitter Probability Pattern combobox. (Values: 1.0, 0.8, 0.6, 0.4, 0.2)
23	Altitude Code switch. (Gilham or Binary)
24	Intruder Identification
25	Mode A Code
26	Velocity Type
27	Utility Message (UM) Field
28	IMF Field
29	Downlink Request (DR) Field
30	Flight Status (FS) Field
31	Transponder Capability (CA) Field

Softkey	Function
Type	Same as menu control item 1
Number	Same as menu control item 2
Enable	Same as menu control item 16
Mode	Same as menu control item 3
Starting At	Same as menu control item 15
Stopping At	Same as menu control item 15
Squitter	Same as menu control item 19
Altitude Report	Same as menu control item 17
Ground	Same as menu control item 18
DO-260 Mode	Same as menu control item 20
Mode S Address	Same as menu control item 21
Tx Channel	Same as menu control item 4
CPR Encoding	Odd/Even, Odd, or Even
Mode S Squitter Menu	
Waypoints	
Ident Format Type	Same as menu control item 24
Altitude Code	Same as menu control item 23

Softkey	Function
Altitude	Same as menu control item 5
Bearing	Same as menu control item 6
Range	Same as menu control item 7
Latitude	Same as menu control item 8
Longitude	Same as menu control item 9
Velocity Type	Same as menu control item 26
Vertical Speed	Same as menu control item 10
Velocity	Same as menu control item 11
Track	Same as menu control item 12
Squitter Power	Same as menu control item 13
Squitter Antenna	Same as menu control item 14
Squitter Probability Pattern	Same as menu control item 22
Mode A – A	Same as menu control item 25
Mode A – B	Same as menu control item 25
Mode A – C	Same as menu control item 25
Mode A – D	Same as menu control item 25
Mode A Ident	Same as menu control item 25
Transponder Capability (CA) Field	Same as menu control item 31
IMF	Same as menu control item 28
Flight Status (FS) Field	Same as menu control item 30
Downlink Request (DR) Field	Same as menu control item 29
Utility Message (UM) Field	Same as menu control item 27

3.1.2.5.11. TCAS Display Menu

Figure 3.1.2.5.11.1 illustrates the TTG-7000 TCAS Display Menu. The TCAS Display Menu allows the user to view the scenario defined during the tests. The own aircraft information is displayed on the bottom left corner of the display.

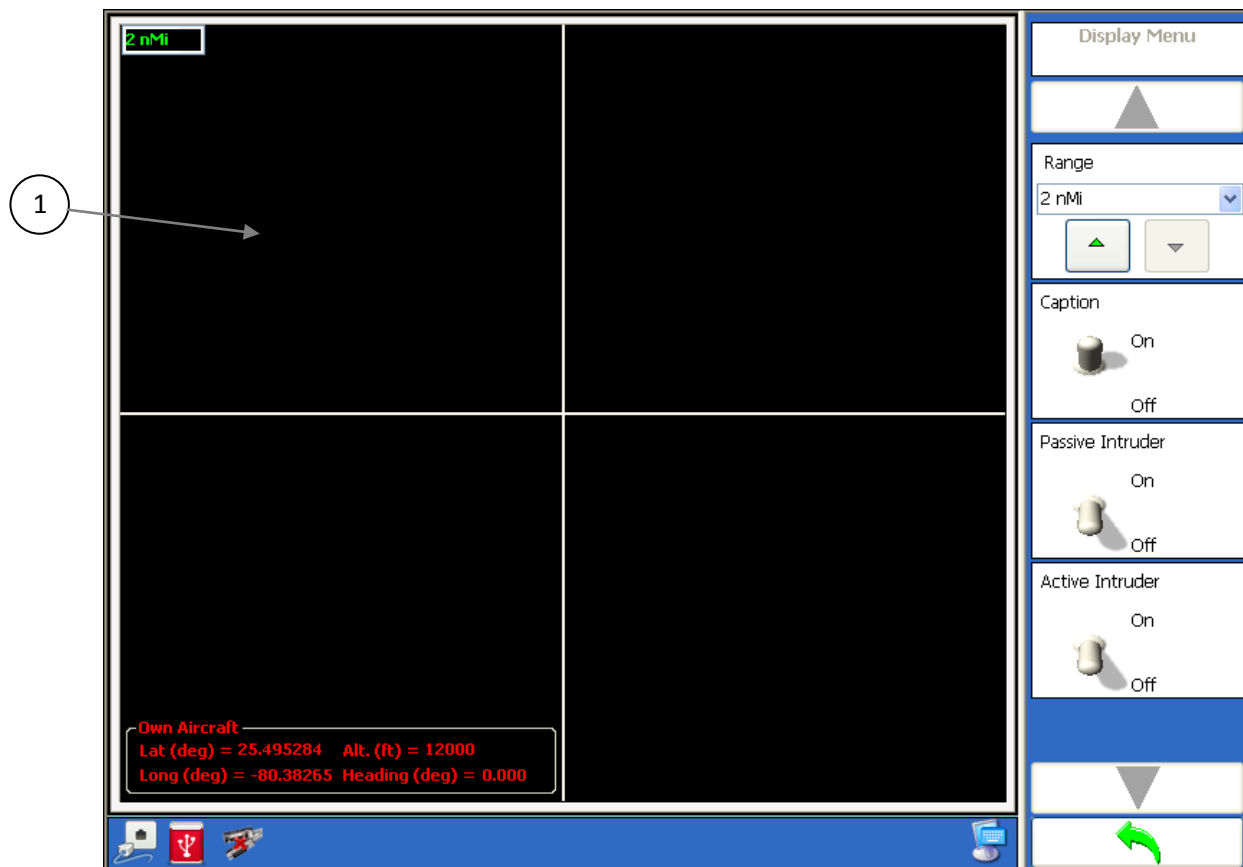

Figure 3.1.2.5.11.1 – TCAS Display Menu

Menu Control	Function
1	Display area

Softkey	Function
Range	Allows selection of display range. (2, 5, 10, 20, 50, or 100 nMi)
Caption	Allows selection whether or not to display caption next to intruder.
Passive Intruder	Allows the display of the passive intruder squitter position.
Active Intruder	Allows the display of the active intruder position.

Note: When an external source (Ethernet or 429) is used the own aircraft information is updated every 5 seconds when a Scenario is not running. The data is updated every second if the scenario is running.

3.1.2.5.12. TCAS Ground Station Menu

Figure 3.1.2.5.12.1 illustrates the TTG-7000 TCAS Ground Station Menu. The TCAS Ground Station Menu allows the user to define up to fifteen (15) different ground stations. The menu also allows the user to define the timeframe and what type of interrogation to perform.

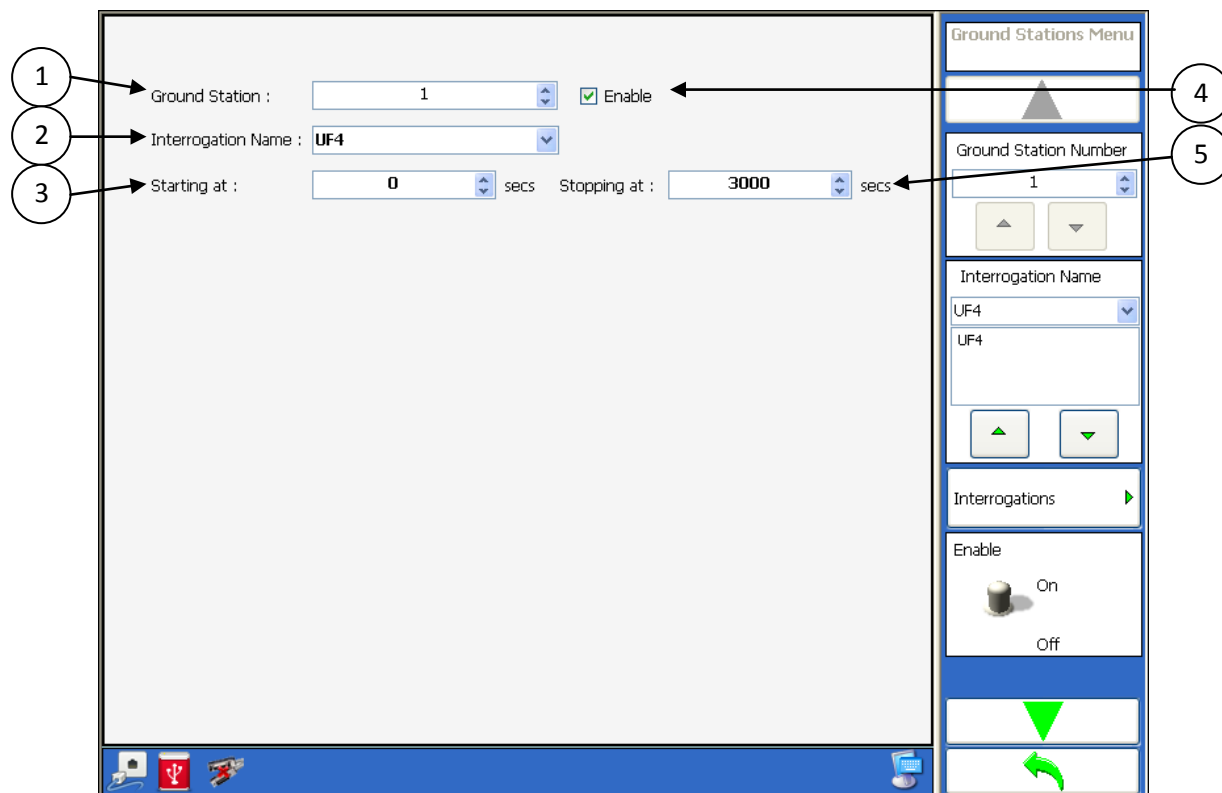

Figure 3.1.2.5.12.1 TCAS Ground Station Menu

Menu Control	Function
1	Ground Station number. Range 1 – 15
2	Interrogation Name combobox. This combobox allows selection of a valid UF message.
3	Starting Time numeric box allows setting the initial time that the selected interrogation will be transmitted.
4	Enable checkbox allows enabling or disabling the current ground station.
5	Stopping Time numeric box allows setting the final time that the selected interrogation will be transmitted.

Softkey	Function
Ground Station Number	Same as menu control item 1
Interrogation Name	Same as menu control item 2
Interrogations	Opens a menu that allows changing the contents of the UF

	message.
Enable	Same as menu control item 4
Starting At	Same as menu control item 3
Stopping At	Same as menu control item 5

Figure 3.1.2.5.12.2 illustrates the TTG-7000 TCAS Ground Station Interrogations Menu. This menu allows the user to modify the contents of the selected UF message in different time sections.

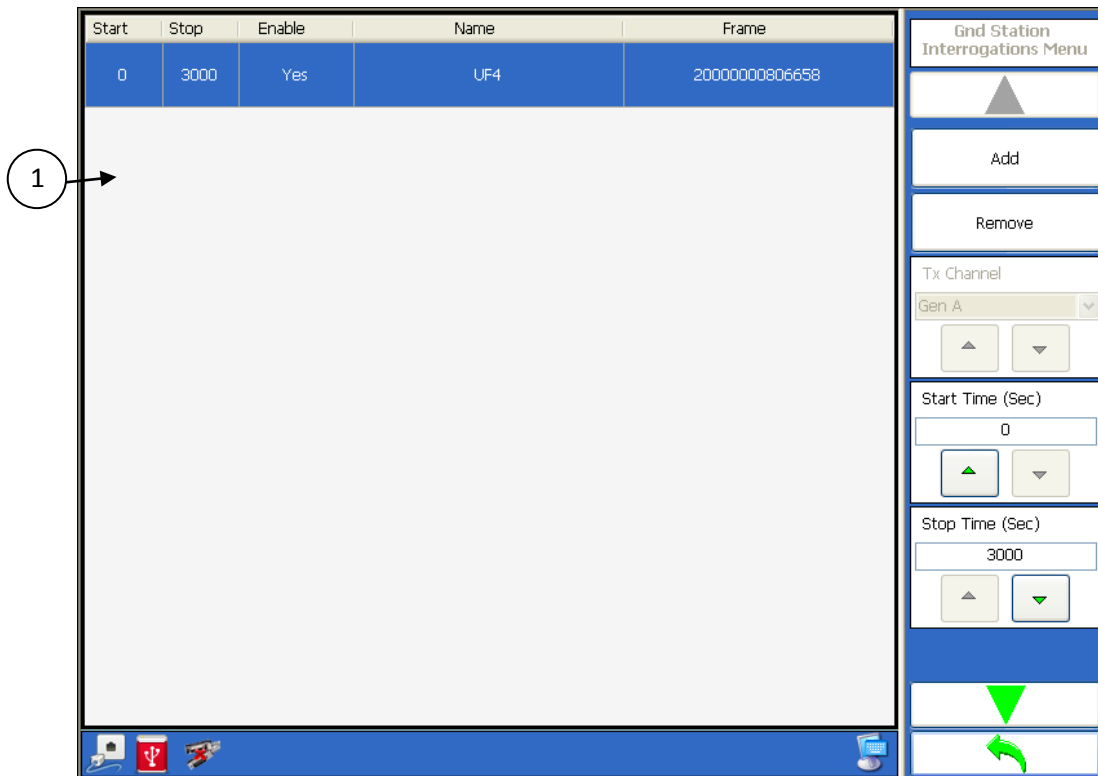

Figure 3.1.2.5.12.2 TCAS Ground Station Interrogations Menu

Menu Control	Function
1	Data grid of all defined UF messages at all timeframes.

Softkey	Function
Add	Adds a new time interval.
Remove	Removes a time interval.
Start Time	Start time for the selected interval.
Stop Time	Stop time for the selected interval.
Enable	Enables or disables transmission during the selected interval.
Frame Details	Opens a menu that illustrates the details for the selected UF message, in order to modify the

Softkey	Function
	contents.

3.1.2.5.13. TCAS ATRBS Pulse Information Menu

Figure 3.1.2.5.13.1 illustrates the TTG-7000 TCAS ATRBS Pulse Information Menu. This menu allows the user to modify the width, position, amplitude and visibility of the ATRBS pulse for a selected generator. The menu also allows changing the rise and fall times for the selected generator.

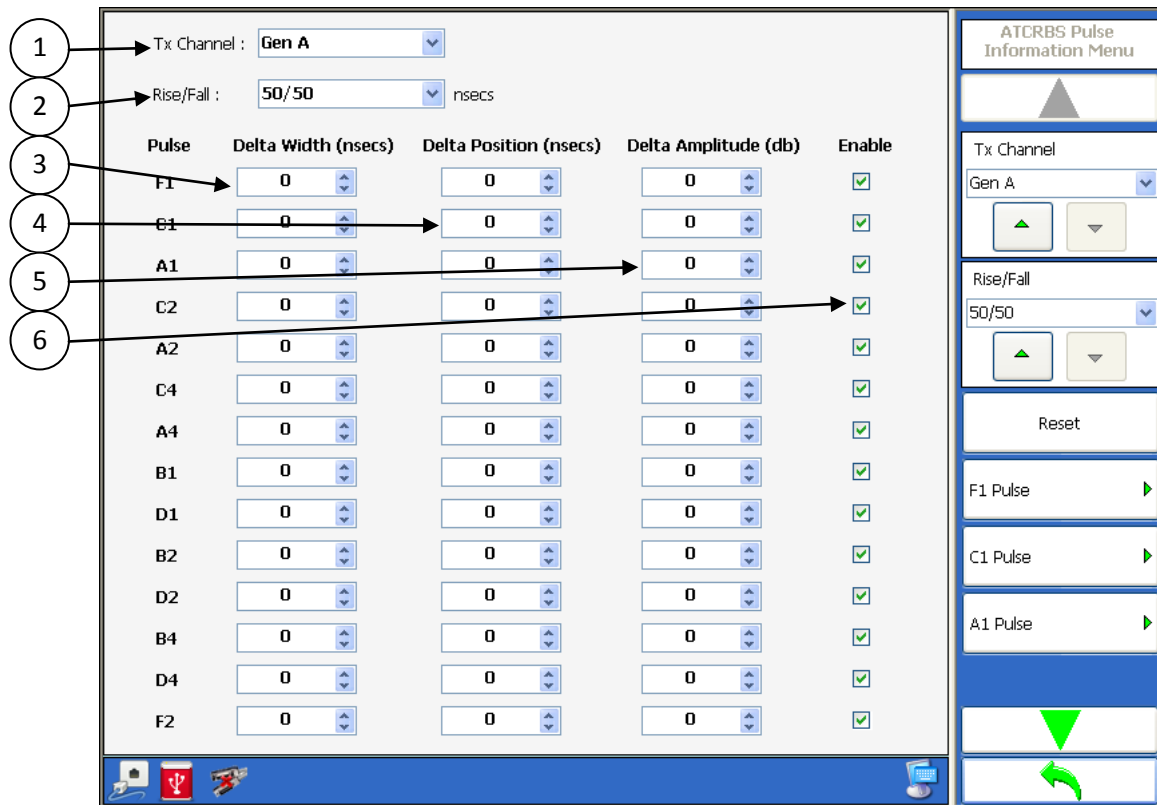

Figure 3.1.2.5.13.1 TCAS ATRBS Pulse Information Menu

Menu Control	Function
1	Tx Channel combobox. (Gen A, Gen C, Gen D)
2	Rise/Fall combobox allows selection of rise and fall time for the selected generator. (50/50, 100/200, 230/230, 600/600 nanoseconds)
3	Delta Width numeric box allows setting the width of each individual pulse.
4	Delta Position numeric box allows setting the position of each individual pulse.
5	Delta Amplitude allows setting the delta amplitude for each individual pulse to 0 or -1 dB.
6	Enable checkbox allows enabling or disabling each individual pulse.

Softkey	Function
Tx Channel	Same as menu control item 1
Rise/Fall	Same as menu control item 2

Softkey		Function
Reset		Sets all values back to default.
F1 Pulse →	Delta Width	Same as menu control item 3
C1 Pulse →	Delta Position	Same as menu control item 4
A1 Pulse →	Delta Amplitude	Same as menu control item 5
C2 Pulse →	Enable	Same as menu control item 6
A2 Pulse →		
C4 Pulse →		
A4 Pulse →		
B1 Pulse →		
D1 Pulse →		
B2 Pulse →		
D2 Pulse →		
B4 Pulse →		
D4 Pulse →		
F2 Pulse →		

3.1.2.5.14. TCAS Mode S Pulse Information Menu

Figure 3.1.2.5.14.1 illustrates the TTG-7000 TCAS Mode S Pulse Information Menu. This menu allows the user to modify the width, position, amplitude and visibility of the Mode S preamble pulses for a selected generator. The menu also allows changing the rise and fall times for the selected generator.

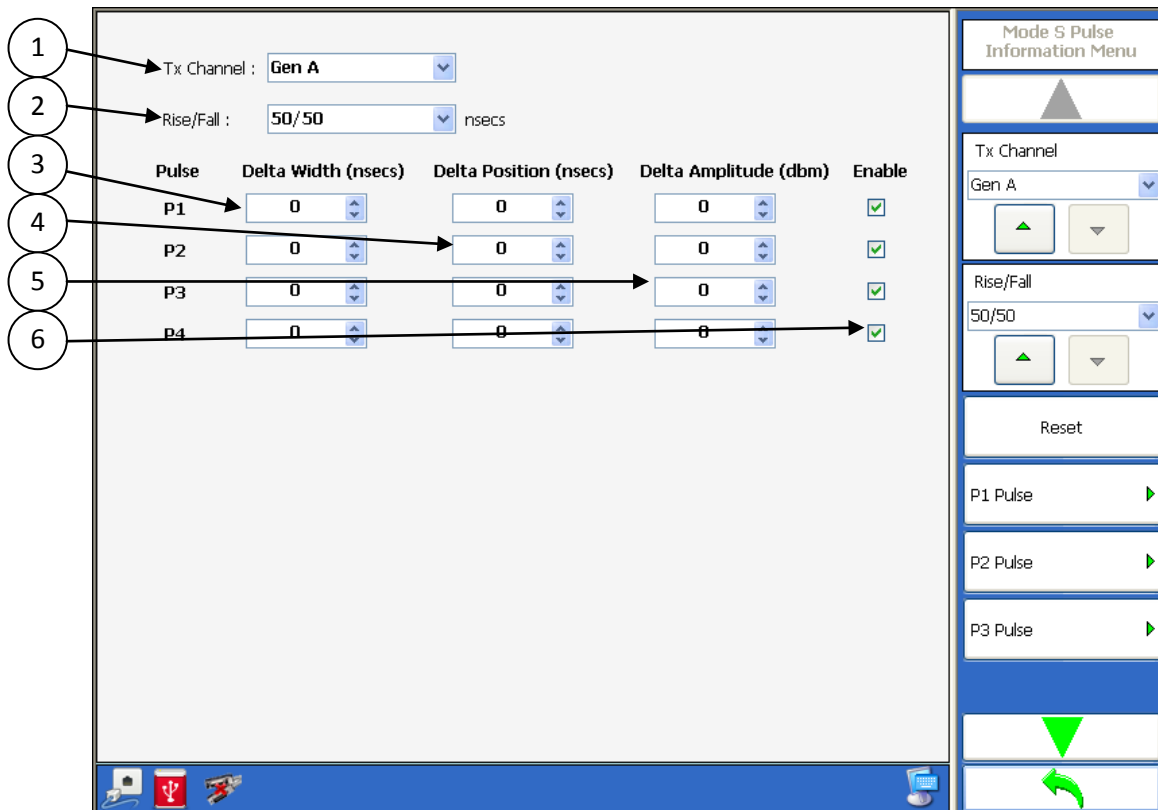

Figure 3.1.2.5.14.1 TCAS Mode S Pulse Information Menu

Menu Control	Function
1	Tx Channel combobox. (Gen A, Gen C, Gen D)
2	Rise/Fall combobox allows selection of rise and fall time for the selected generator. (50/50, 100/200, 230/230, 600/600 nanoseconds)
3	Delta Width numeric box allows setting the width of each individual pulse.
4	Delta Position numeric box allows setting the position of each individual pulse.
5	Delta Amplitude allows setting the delta amplitude for each individual pulse to 0 or -1 dB.
6	Enable checkbox allows enabling or disabling each individual pulse.

Softkey		Function
Tx Channel		Same as menu control item 1
Rise/Fall		Same as menu control item 2
Reset		Sets all values back to default.
P1 Pulse →	Delta Width	Same as menu control item 3
P2 Pulse →	Delta Position	Same as menu control item 4
P3 Pulse →	Delta Amplitude	Same as menu control item 5
P4 Pulse →	Enable	Same as menu control item 6

3.1.2.5.15. TCAS Video Blocks Menu

Figure 3.1.2.5.15.1 illustrates the TTG-7000 TCAS Video Blocks Definition Menu. This menu allows the user to define the video block and trigger mechanism to transmit the block. Figure 3.1.2.5.15.1 shows the Mode S trigger source and Figure 3.1.2.5.15.2 shows the ATRCBS trigger source.

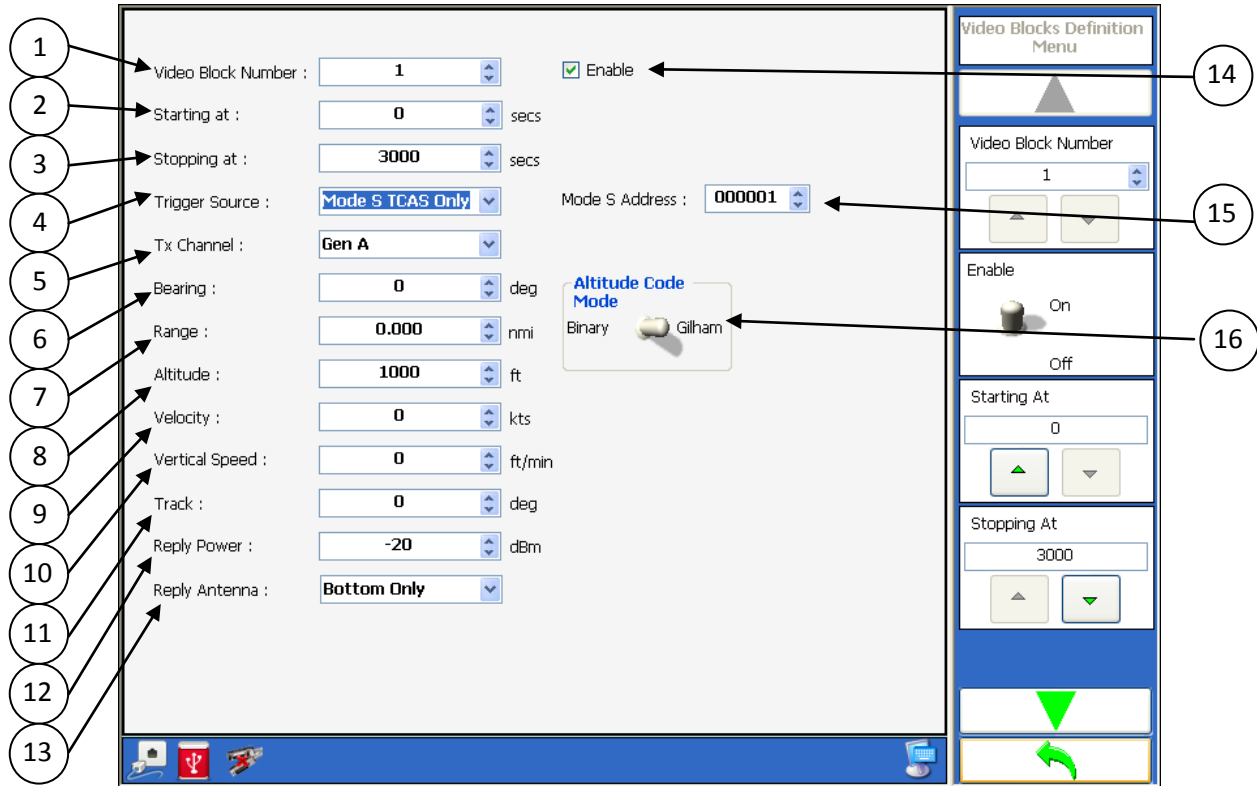

Figure 3.1.2.5.15.1 TCAS Video Blocks Definition Menu

Menu Control	Function
1	Video Block numeric box.
2	Starting at numeric box allows setting the initial time for video block transmission.
3	Stopping at numeric box allows setting the final time for video block transmission.
4	Trigger Source combobox allows setting the trigger source to either Mode C or Mode S interrogation.
5	Tx Channel combobox allows setting the transmitter to transmit the video block.
6	Bearing numeric box allows setting the bearing of the transmitter when transmitting the video block.
7	Range numeric box allows setting the time delay from the trigger.
8	Altitude numeric box. Used only if dynamic velocity not 0.
9	Velocity numeric box.

Menu Control	Function
10	Vertical Speed numeric box. Used only if dynamic velocity not 0.
11	Track numeric box. Used only if dynamic velocity not 0.
12	Reply Power numeric box. Low power range -20 to -90 dBm in 1 dB steps. High power range from 1 to -69 dBm.
13	Reply Antenna combobox. (Top Only, Bottom Only, Alternating, Both, By Altitude)
14	Enable checkbox allows enabling or disabling the video block.
15	Mode S Address numeric box.
16	Altitude Code switch (Gilham or Binary)

Softkey	Function
Video Block Number	Same as menu control item 1
Enable	Same as menu control item 14
Starting At	Same as menu control item 2
Stopping At	Same as menu control item 3
Trigger Source	Same as menu control item 4
Mode S Address	Same as menu control item 15
Tx channel	Same as menu control item 5
Bearing	Same as menu control item 6
Range	Same as menu control item 7
Altitude Code	
Altitude	Same as menu control item 8
Velocity	Same as menu control item 9
Vertical Speed	Same as menu control item 10
Track	Same as menu control item 11
Reply Power	Same as menu control item 12
Reply Antenna	Same as menu control item 13
One Shot Video Data	
Video Waypoints	
Video Data Bit →	Opens a new menu to define the data bits

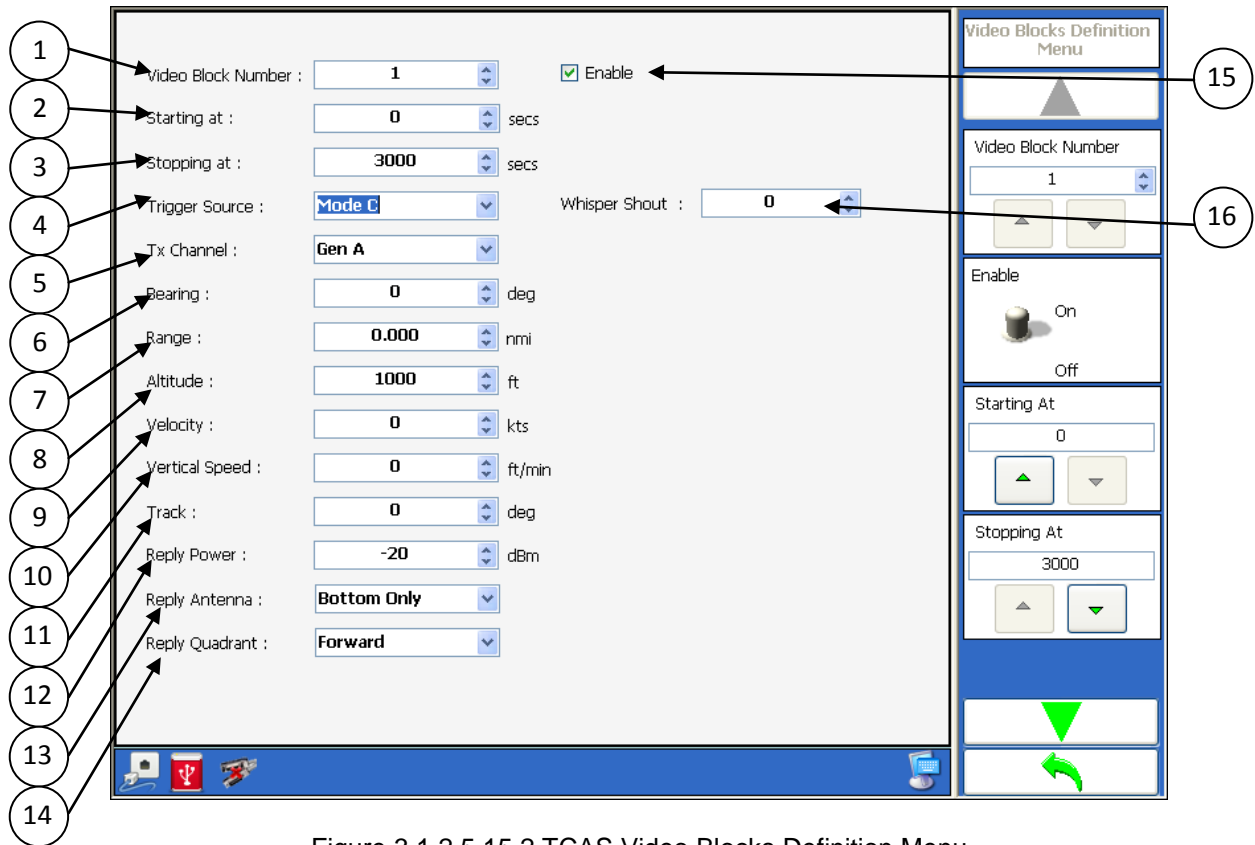

Figure 3.1.2.5.15.2 TCAS Video Blocks Definition Menu

Menu Control	Function
1	Video Block numeric box.
2	Starting at numeric box allows setting the initial time for video block transmission.
3	Stopping at numeric box allows setting the final time for video block transmission.
4	Trigger Source combobox allows setting the trigger source to either Mode C or Mode S interrogation.
5	Tx Channel combobox allows setting the transmitter to transmit the video block.
6	Bearing numeric box allows setting the bearing of the transmitter when transmitting the video block.
7	Range numeric box allows setting the time delay from the trigger.
8	Altitude numeric box. Used only if dynamic velocity not 0.
9	Velocity numeric box.
10	Vertical Speed numeric box. Used only if dynamic velocity not 0.
11	Track numeric box. Used only if dynamic velocity not 0.
12	Reply Power numeric box. Low power range -20 to -90 dBm in 1 dB steps. High power range from 1 to -69 dBm.
13	Reply Antenna combobox. (Top Only, Bottom Only, Alternating, Both, By Altitude)
14	Reply Quadrant combobox. (Forward, Right, After, Left, Any Quadrant)
15	Enable checkbox allows enabling or disabling the video block.
16	Whisper Shout Level

Softkey	Function
Video Block Number	Same as menu control item 1
Enable	Same as menu control item 15
Starting At	Same as menu control item 2
Stopping At	Same as menu control item 3
Trigger Source	Same as menu control item 4
Whisper Shout Level	Same as menu control item 16
Tx channel	Same as menu control item 5
Bearing	Same as menu control item 6
Range	Same as menu control item 7
Altitude	Same as menu control item 8
Velocity	Same as menu control item 9
Vertical Speed	Same as menu control item 10
Track	Same as menu control item 11
Reply Power	Same as menu control item 12
Reply Antenna	Same as menu control item 13
Reply Quadrant	Same as menu control item 14
One Shot Video Data	
Video Waypoints	
Video Data Bit →	Opens a new menu to define the data bits

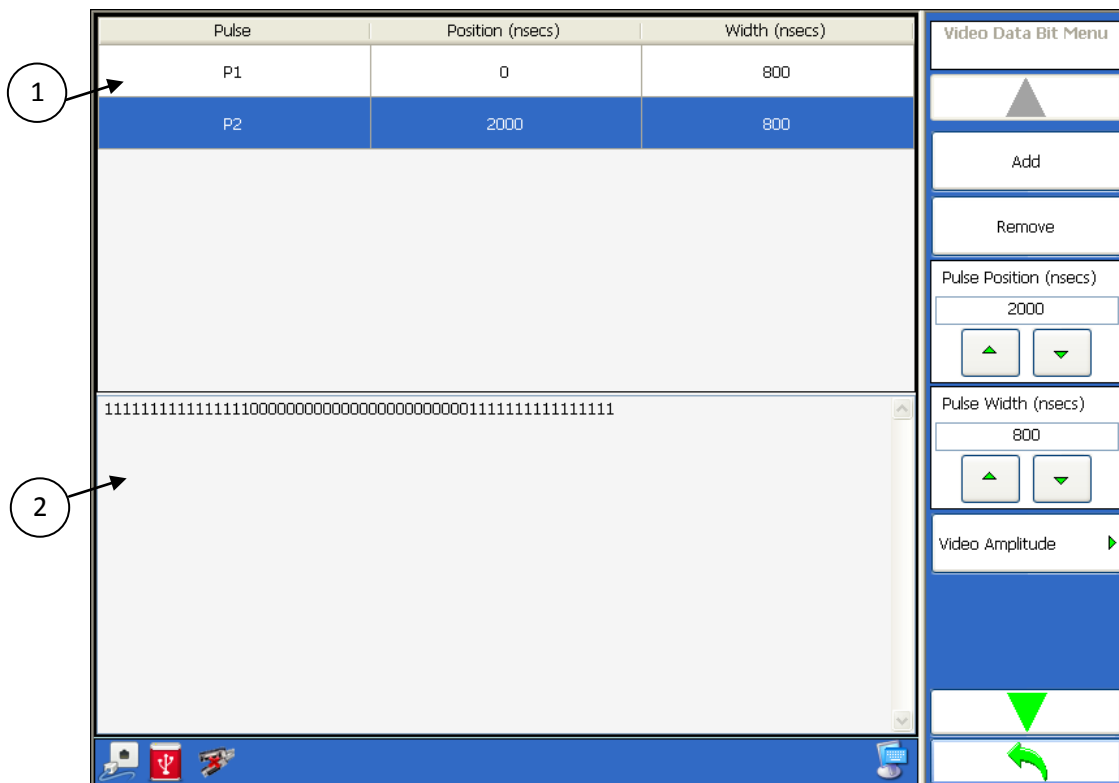

Figure 3.1.2.5.15.3 TCAS Video Data Bit Menu

Menu Control	Function
1	Displays a list of all the pulses defined with the starting location and width.
2	Displays the video bits using the selected bit width of 25 or 50 nanoseconds.

Softkey	Function
Add	Adds a new pulse.
Remove	Removes the selected pulse.
Pulse Position	Starting position of the selected pulse.
Pulse Width	Width of the selected pulse.
Video Amplitude →	Open a menu that allows setting the amplitude of each bit from 3 to -4 dB
Video Format	Sets the format of displaying the video bits in hexadecimal or binary.

3.1.2.6. TCAS ATE Line Menu

Figure 3.1.2.6.1 illustrates the TTG-7000 TCAS ATE Line Menu. The TCAS ATE Line Menu allows the user to view the information being received via the ATE Lines connector.

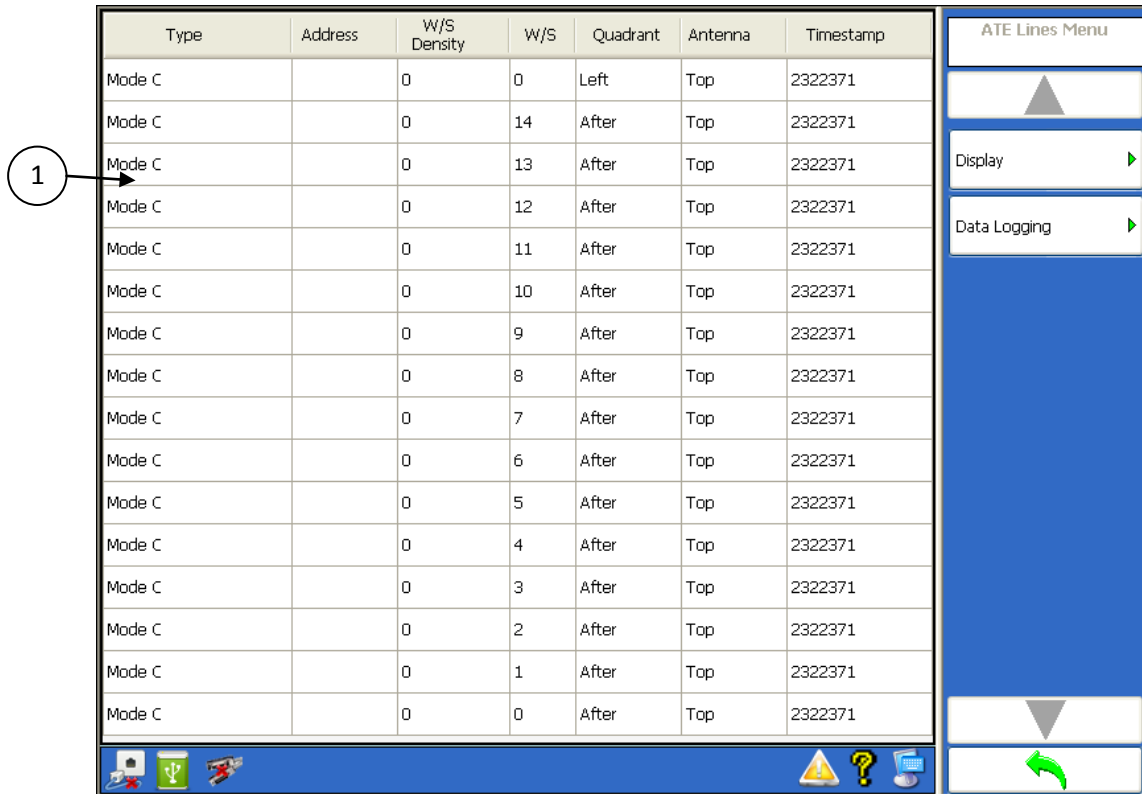

Figure 3.1.2.6.1 – TCAS ATE Line Menu

Menu Control	Function
1	Data grid of all received ATE Lines

Softkey	Function
Display→	On/Off Enable/disable displaying ATE Line receptions
Mode→	Update Updates ATE Line data with information from an identical data.
	Continuous Displays all ATE Line receptions.
	Clear Clears all messages in the ATE Line menu.

Softkey	Function
Quantity to show	Allows the operator to enter quantity of lines to view.
Refresh	Refreshes the screen with the quantity of messages.

3.1.2.7. TCAS Chamber Mode Menu

Figure 3.1.2.7.1 illustrates the TTG-7000 Chamber Mode Menu. The TCAS Chamber Mode Menu allows the user to set the path loss between the outputs of the TTG-7000C RF Amplifier unit and the TCAS Processor Antenna input port. It also allows the setting of the Fruit power levels.

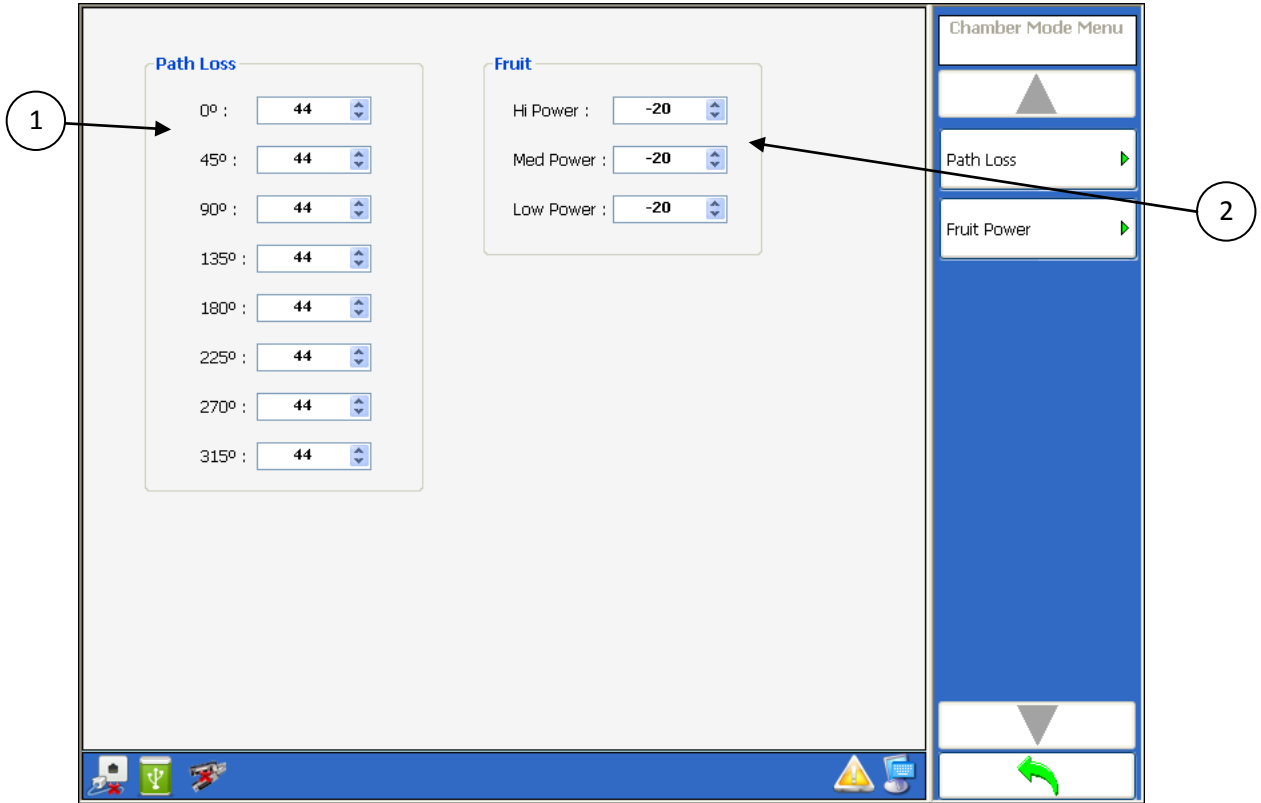

Figure 3.1.2.7.1 – TCAS Chamber Mode Menu

Menu Control	Function
1	Path loss for every chamber antenna port
2	Fruit power levels

Softkey	Function
Path Loss→	
0°	Path Loss for 0° port
45°	Path Loss for 45° port

Softkey		Function
	90°	Path Loss for 90° port
	135°	Path Loss for 135° port
	180°	Path Loss for 180° port
	225°	Path Loss for 225° port
	270°	Path Loss for 270° port
	315°	Path Loss for 315° port
Fruit Power→		
	Hi Power	Fruit Hi power level
	Med Power	Fruit Med power level
	Low Power	Fruit Low power level

3.1.2.8. Measurement Menu

Figure 3.1.2.8.1 and 3.1.2.8.2 illustrates the TTG-7000 Measurement Menu. The Measurement Menu allows the user to view the pulses from the TCAS Processor or Transponder. The Measurement Menu allows the user to make measurements for power, pulsewidth, risetime, falltime, spacing, frequency, and phase.

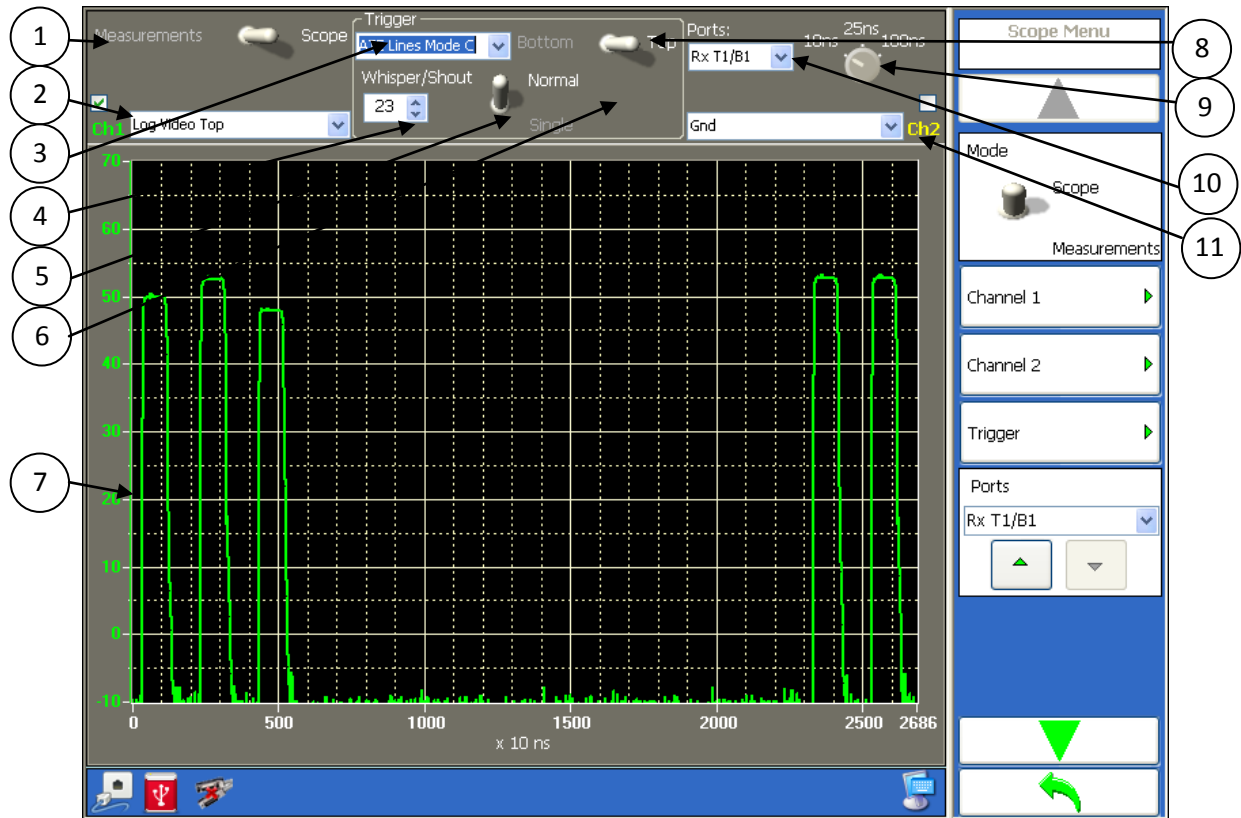

Figure 3.1.2.8.1 – Scope Menu

Menu Control	Function
1	Measurement/Scope control. Allows the user to perform a measurement or set the scope to view a received waveform.
2	Channel 1 selection.
3	Trigger source selection (Log Video, ATE Line Mode S, ATE Line Mode A, or ATE Line Mode C).
4	Trigger level selection. If ATE Line Mode C is selected for the trigger source then a combobox to select whisper/shout level is displayed. If Log Video is selected for the trigger source then a slider for power level is displayed. If ATE Line Mode S is selected for trigger source then no control is displayed.

Menu Control	Function
5	Trigger mode. (Single, Normal)
6	Trigger edge. (+ or -). Only displayed if trigger source is Log Video.
7	Waveform graph area. Dragging the mouse or finger on the touchscreen over the axis and graph can change the horizontal/vertical scales and horizontal/vertical positions.
8	Trigger Antenna (Top or Bottom).
9	Sampling timespan. (10, 25, or 100 nanoseconds)[100, 40, or 10 MHz]
10	Receiver Port
11	Channel 2 selection

Softkey	Function
Scope/Measurement	Same as menu control item 1
Channel 1	
Enable	
Source	Same as menu control item 2
Clear	
Channel 2	
Enable	
Source	Same as menu control item 11
Clear	
Trigger	
Level	Same as menu control item 4
Edge	Same as menu control item 6
Source	Same as menu control item 3
Antenna	Same as menu control item 8
Ports	Same as menu control item 10
Horizontal Scale	Same as menu control item 9
Signal Test	

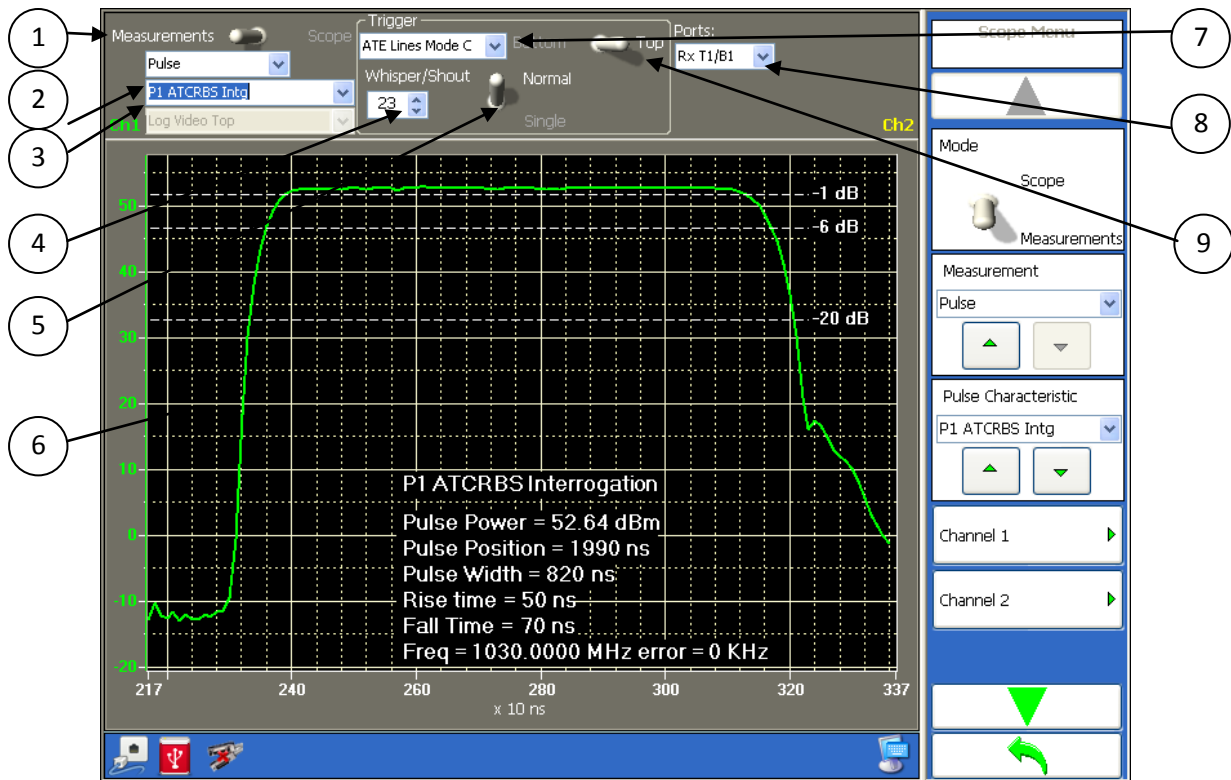

Figure 3.1.2.8.2 – Measurement Menu

Menu Control	Function
1	Measurement/Scope control. Allows the user to perform a measurement or set the scope to view a received waveform.
2	Measurement type (Pulse, Frequency, Phase)
3	Pulse selection combobox.
4	Trigger level selection. If ATE Line Mode C is selected for the trigger source then a combobox to select whisper/shout level is displayed. If Log Video is selected for the trigger source then a slider for power level is displayed. If ATE Line Mode S is selected for trigger source then no control is displayed.
5	Trigger mode. (Single, Normal)
6	Waveform graph area. Dragging the mouse or finger on the touchscreen over the axis and graph can change the horizontal/vertical scales and horizontal/vertical positions.
7	Trigger source selection (Log Video, ATE Line Mode S, ATE Line Mode A, or ATE Line Mode C).
8	Receiver Port
9	Top/Bottom Antenna selection.

Softkey	Function
Scope/Measurement	Same as menu control item 1
Measurement type	Same as menu control item 2

Softkey	Function
Pulse selection	Same as menu control item 3
Channel 1	
Channel 2	
Trigger	
Level	Same as menu control item 4
Edge	Same as menu control item 6
Source	Same as menu control item 7
Antenna	Same as menu control item 9
Mode	Same as menu control item 5
Ports	Same as menu control item 8
Signal Test	

3.1.3. Transponder Menu

Figure 3.1.3.1 illustrates the TTG-7000 Transponder Menu.

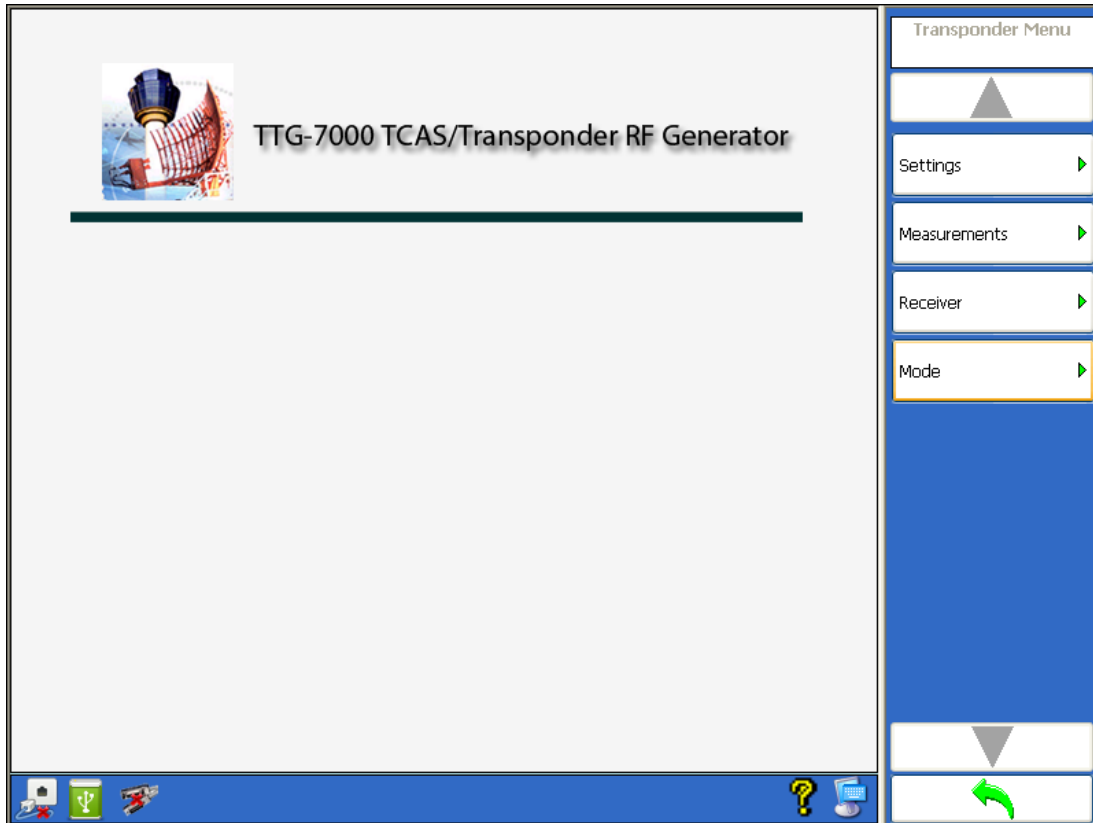

Figure 3.1.3.1 – Transponder Menu

Softkey	Function
Settings	
Measurements	
Receiver Menu	
Mode →	
	Mode A
	Mode C
	Mode A All-Call
	Mode C All-Call
	Mode A/Mode S All-Call
	Mode C/Mode S All-Call
	Mode S

3.1.3.1. Transponder Settings

Figure 3.1.3.1.1 illustrates the TTG-7000 Transponder Settings Menu. The Transponder Settings Menu allows the user to configure the Transmitter, Receiver, and Antenna Simulator modules within the test set for transponder tests. This menu is mainly used for testing and troubleshooting of the TTG-7000. For Transponder unit testing, this menu should only be used to set the individual RF generator frequencies.

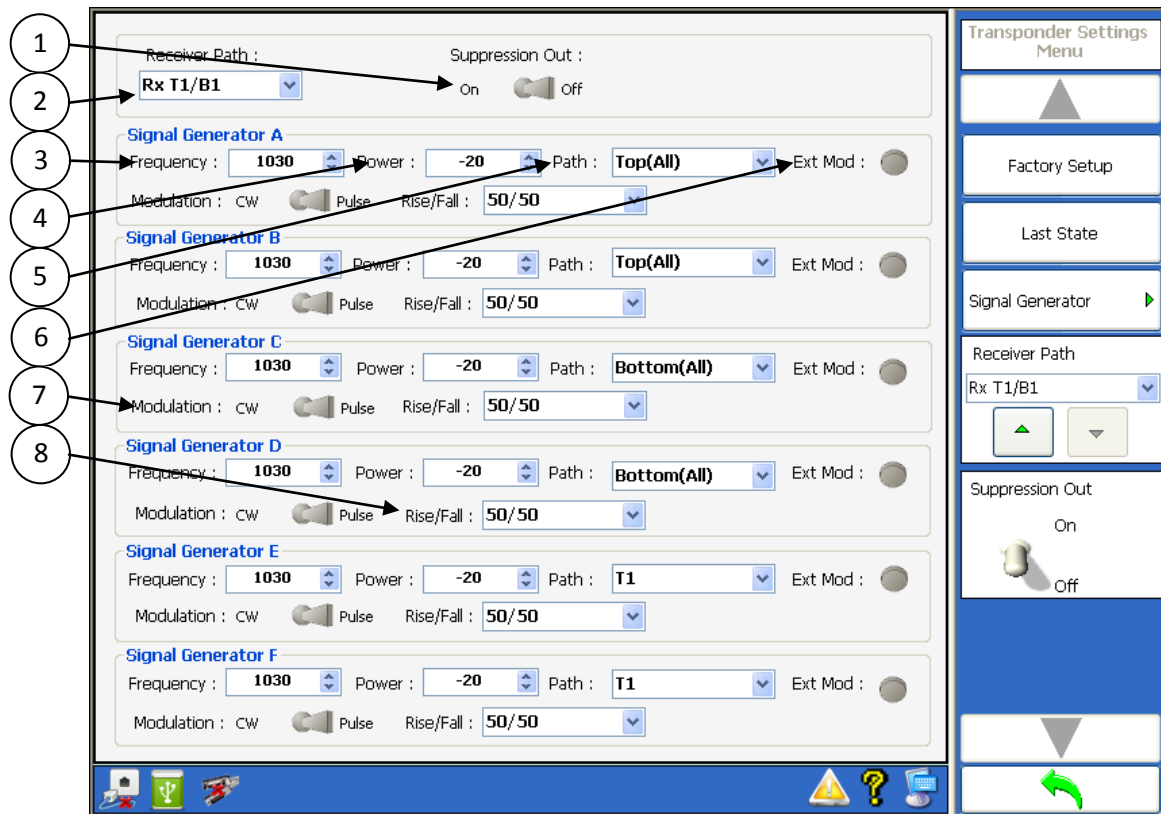

Figure 3.1.3.1.1 – Transponder Settings Menu

Menu Control	Function
1	Suppression Out On/Off. Future use.
2	Receiver Path Combobox allows the user to select which port to connect the Top/Bottom Receiver. Selections available are Rx T1/B1, Rx T2/B2, Rx T3/B3, Rx T4/B4, Chamber, or Combine.
3	Tx Frequency Numeric Box allows the setting of the Transmitter frequency. Individual setting for each transmitter. Range from 962 to 1213 MHz in 0.1 MHz steps.
4	Tx Power Numeric Box allows the setting of the Transmitter power from -20 to -90 dBm in 1 dB steps.

Menu Control	Function
5	Tx Path allows setting the Tx path to Top All Ports/Bottom All Ports/Single Port.
6	External Modulation On/Off. Future use.
7	Modulation CW/Pulse
8	Pulse Risetime/Falltime slow or normal.

Softkey	Function
Factory Settings	Sets all hardware to default setting according to hardware configuration.
Signal Generator Menu →	
Generator A →	
Frequency	Same as menu control item 3.
Modulation	Same as menu control item 7.
Path	Same as menu control item 5.
Power	Same as menu control item 4.
Rise/Fall	Same as menu control item 8.
Ext. Mod	Same as menu control item 6.
Generator B	Same as Generator A.
Generator C	Same as Generator A.
Generator D	Same as Generator A.
Generator E	Same as Generator A.
Generator F	Same as Generator A.
Receiver Path	Same as menu control item 2.
Suppression Out On/Off	Future use.

3.1.3.2. Transponder Mode A Menu

Figure 3.1.3.2.1 illustrates the TTG-7000 Transponder Mode A Menu. The Transponder Mode A Menu allows the user to setup the test set for Mode A interrogations.

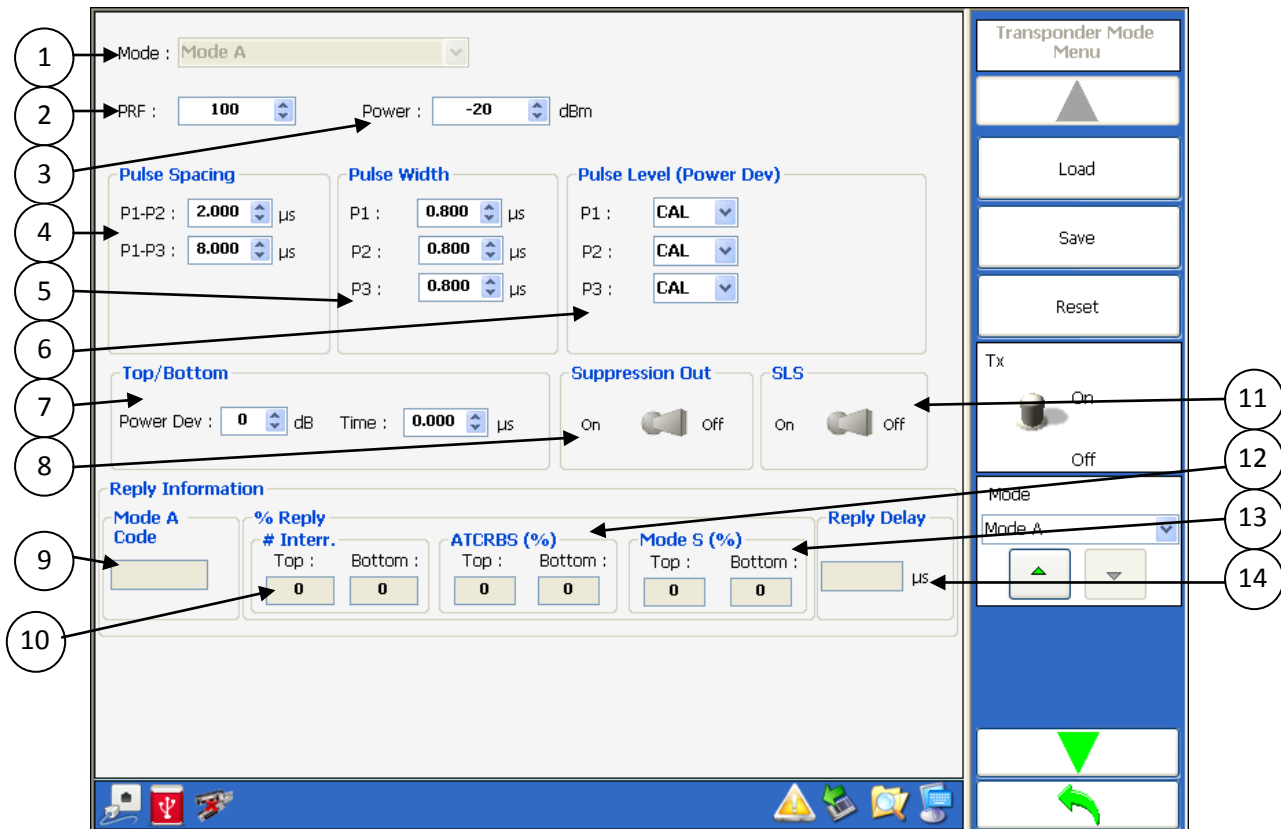

Figure 3.1.3.2.1 – Transponder Mode A Menu

Menu Control	Function
1	Interrogation mode
2	PRF. Range 1-2500 Hz.
3	Power. Range -20 to -90 dBm in 1 dB steps.
4	Pulse Spacing. P1-P2 (1-3 microseconds). P1-P3 (7.025-8.975 microseconds). Spacing steps in 0.025 microseconds.
5	Pulse Width. (0.025-1.950 microseconds). Steps in 0.025 microseconds.
6	Pulse Level. (CAL, VAR, OFF). Variable range +9 to -19 dB. All signals above -20 are limited to -20.
7	Top/Bottom settings. Time deviation +/- 0.975 microseconds in 0.025 microseconds steps. Power deviation 0 to +5 dB in 1 dB steps.

Menu Control	Function
8	Suppression Out. When enabled sends a suppression pulse on the Supp BNC.
9	Mode A code from reply.
10	Number of interrogations top and bottom antenna from last request.
11	SLS On/Off
12	Percent reply ATCRBS Top/Bottom.
13	Percent reply Mode S Top/Bottom.
14	Reply Delay

Softkey	Function
Default	Sets all settings on the screen to default Mode A interrogation settings.
Tx On/Off	Turns on or off interrogations.
Mode	Same as menu control item 1.
PRF	Same as menu control item 2.
Power Level	Same as menu control item 3.
Pulse Spacing →	
	P1-P2 Same as menu control item 4.
	P1-P3 Same as menu control item 4.
Pulse Width →	
	P1 Same as menu control item 5.
	P2 Same as menu control item 5.
	P3 Same as menu control item 5.
Pulse Level →	
P1	VAR/CAL/OFF Same as menu control item 6.
P1	Power Deviation Same as menu control item 6.
P2	VAR/CAL/OFF Same as menu control item 6.
P2	Power Deviation Same as menu control item 6.
P3	VAR/CAL/OFF Same as menu control item 6.
P3	Power Deviation Same as menu control item 6.
SLS	Same as menu control item 11.
Top/Bottom →	
	Power Deviation Same as menu control item 7.
	Time Same as menu control item 7.
Suppression Out	Same as menu control item 8.

3.1.3.3. Transponder Mode C Menu

Figure 3.1.3.3.1 illustrates the TTG-7000 Transponder Mode C Menu. The Transponder Mode C Menu allows the user to setup the test set for Mode C interrogations.

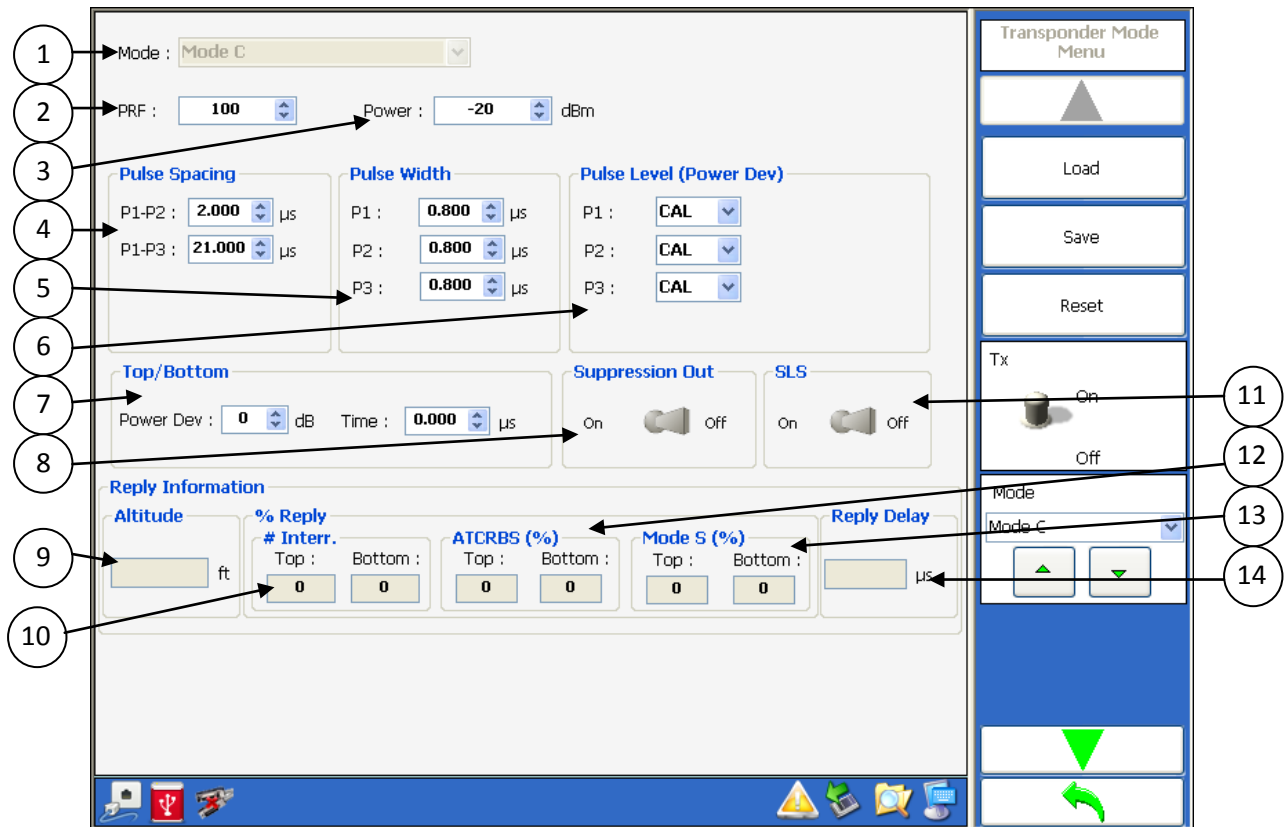

Figure 3.1.3.3.1 – Transponder Mode C Menu

Menu Control	Function
1	Interrogation mode
2	PRF. Range 1-2500 Hz.
3	Power. Range -20 to -90 dBm in 1 dB steps.
4	Pulse Spacing. P1-P2 (1-3 microseconds). P1-P3 (20.025-21.975 microseconds). Spacing steps in 0.025 microseconds.
5	Pulse Width. (0.025-1.950 microseconds). Steps in 0.025 microseconds.
6	Pulse Level. (CAL, VAR, OFF). Variable range +9 to -19 dB. All signals above -20 are limited to -20.
7	Top/Bottom settings. Time deviation +/- 0.975 microseconds in 0.025 microseconds steps. Power deviation 0 to +5 dB in 1 dB steps.

Menu Control	Function
8	Suppression Out. When enabled sends a suppression pulse on the Supp BNC.
9	Mode C altitude from reply.
10	Number of interrogations top and bottom antenna from last request.
11	SLS On/Off
12	Percent reply ATCRBS Top/Bottom.
13	Percent reply Mode S Top/Bottom.
14	Reply Delay

Softkey	Function
Default	Sets all settings on the screen to default Mode C interrogation settings.
Tx On/Off	Turns on or off interrogations.
Mode	Same as menu control item 1.
PRF	Same as menu control item 2.
Power Level	Same as menu control item 3.
Pulse Spacing →	
	P1-P2 Same as menu control item 4.
	P1-P3 Same as menu control item 4.
Pulse Width →	
	P1 Same as menu control item 5.
	P2 Same as menu control item 5.
	P3 Same as menu control item 5.
Pulse Level →	
P1	VAR/CAL/OFF Same as menu control item 6.
P1	Power Deviation Same as menu control item 6.
P2	VAR/CAL/OFF Same as menu control item 6.
P2	Power Deviation Same as menu control item 6.
P3	VAR/CAL/OFF Same as menu control item 6.
P3	Power Deviation Same as menu control item 6.
SLS	Same as menu control item 11.
Top/Bottom →	
	Power Deviation Same as menu control item 7.
	Time Same as menu control item 7.
Suppression Out	Same as menu control item 8.

3.1.3.4. Transponder Mode A All-Call Menu

Figure 3.1.3.4.1 illustrates the TTG-7000 Transponder Mode A All-Call Menu. The Transponder Mode A All-Call Menu allows the user to setup the test set for Mode A All-Call interrogations.

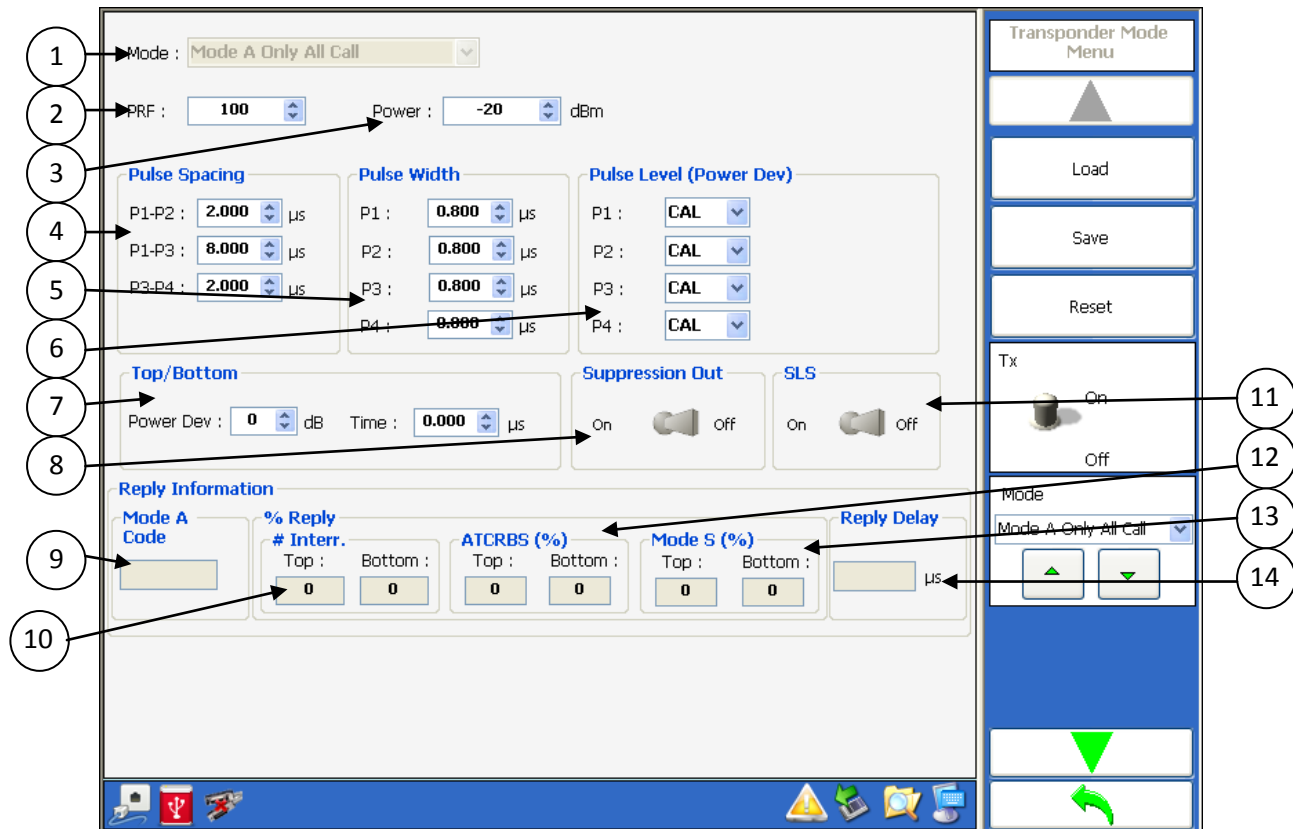

Figure 3.1.3.4.1 – Transponder Mode A All-Call Menu

Menu Control	Function
1	Interrogation mode
2	PRF. Range 1-2500 Hz.
3	Power. Range -20 to -90 dBm in 1 dB steps.
4	Pulse Spacing. P1-P2 (1-3 microseconds). P1-P3 (20.025-21.975 microseconds). P3-P4 (1-3 microseconds). Spacing steps in 0.025 microseconds.
5	Pulse Width. (0.025-1.950 microseconds). Steps in 0.025 microseconds.
6	Pulse Level. (CAL, VAR, OFF). Variable range +9 to -19 dB. All signals above -20 are limited to -20.
7	Top/Bottom settings. Time deviation +/- 0.975 microseconds in 0.025 microseconds steps. Power deviation 0 to +5 dB in 1 dB steps.

Menu Control	Function
8	Suppression Out. When enabled sends a suppression pulse on the Supp BNC.
9	Mode A code from reply.
10	Number of interrogations top and bottom antenna from last request.
11	SLS On/Off
12	Percent reply ATCRBS Top/Bottom.
13	Percent reply Mode S Top/Bottom.
14	Reply Delay

Softkey	Function
Default	Sets all settings on the screen to default Mode A All-Call interrogation settings.
Tx On/Off	Turns on or off interrogations.
Mode	Same as menu control item 1.
PRF	Same as menu control item 2.
Power Level	Same as menu control item 3.
Pulse Spacing →	
	P1-P2 Same as menu control item 4.
	P1-P3 Same as menu control item 4.
	P3-P4 Same as menu control item 4.
Pulse Width →	
	P1 Same as menu control item 5.
	P2 Same as menu control item 5.
	P3 Same as menu control item 5.
	P4 Same as menu control item 5.
Pulse Level →	
P1	VAR/CAL/OFF Same as menu control item 6.
P1	Power Deviation Same as menu control item 6.
P2	VAR/CAL/OFF Same as menu control item 6.
P2	Power Deviation Same as menu control item 6.
P3	VAR/CAL/OFF Same as menu control item 6.
P3	Power Deviation Same as menu control item 6.
P4	VAR/CAL/OFF Same as menu control item 6.
P4	Power Deviation Same as menu control item 6.
SLS	Same as menu control item 11.
Top/Bottom →	
	Power Deviation Same as menu control item 7.
	Time Same as menu control item 7.
Suppression Out	Same as menu control item 8.

3.1.3.5. Transponder Mode C All-Call Menu

Figure 3.1.3.5.1 illustrates the TTG-7000 Transponder Mode C All-Call Menu. The Transponder Mode C All-Call Menu allows the user to setup the test set for Mode C All-Call interrogations.

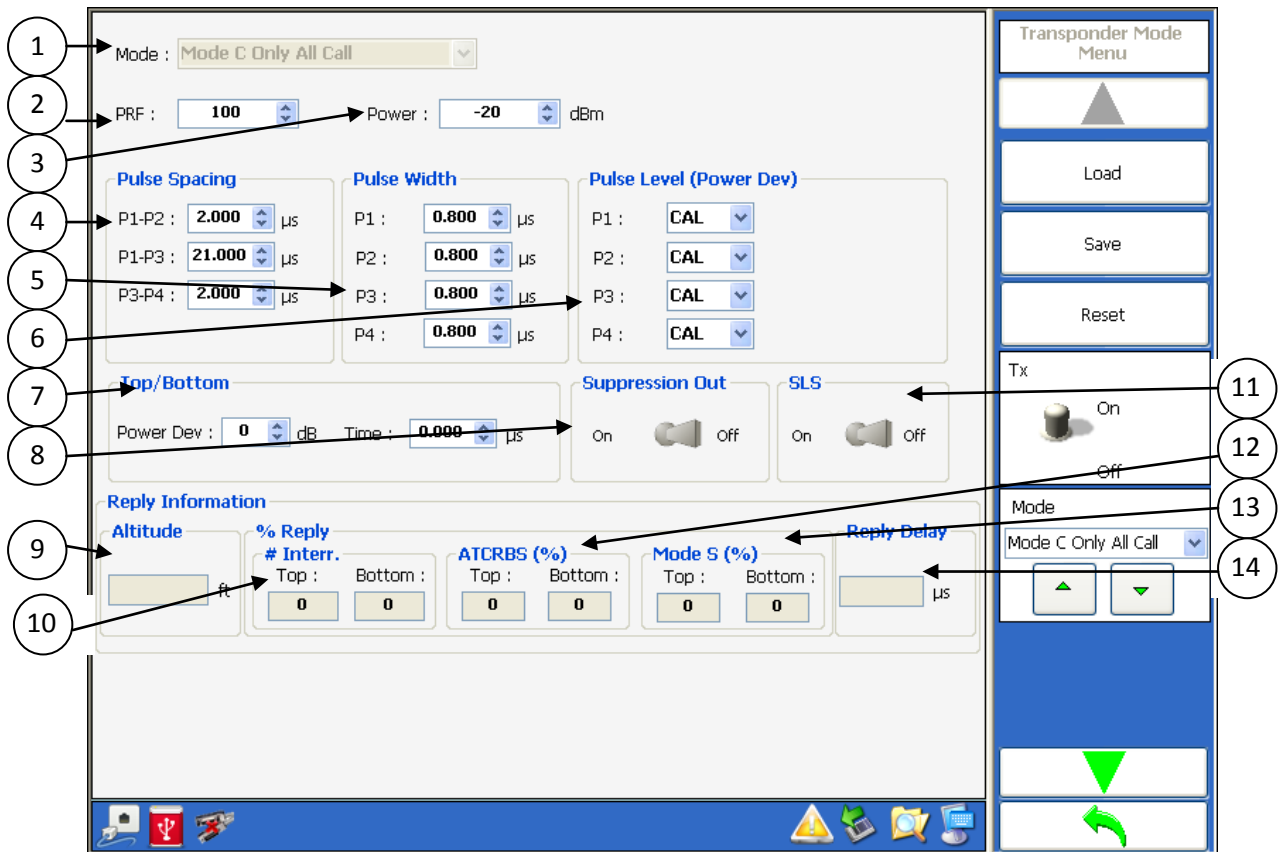

Figure 3.1.3.5.1 – Transponder Mode C All-Call Menu

Menu Control	Function
1	Interrogation mode
2	PRF. Range 1-2500 Hz.
3	Power. Range -20 to -90 dBm in 1 dB steps.
4	Pulse Spacing. P1-P2 (1-3 microseconds). P1-P3 (20.025-21.975 microseconds). P3-P4 (1-3 microseconds). Spacing steps in 0.025 microseconds.
5	Pulse Width. (0.025-1.950 microseconds). Steps in 0.025 microseconds.
6	Pulse Level. (CAL, VAR, OFF). Variable range +9 to -19 dB. All signals above -20 are limited to -20.
7	Top/Bottom settings. Time deviation +/- 0.975 microseconds in 0.025 microseconds steps. Power deviation 0 to +5 dB in 1 dB steps.

Menu Control	Function
8	Suppression Out. When enabled sends a suppression pulse on the Supp BNC.
9	Mode C altitude from reply.
10	Number of interrogations top and bottom antenna from last request.
11	SLS On/Off
12	Percent reply ATCRBS Top/Bottom.
13	Percent reply Mode S Top/Bottom.
14	Reply Delay

Softkey	Function
Default	Sets all settings on the screen to default Mode C All-Call interrogation settings.
Tx On/Off	Turns on or off interrogations.
Mode	Same as menu control item 1.
PRF	Same as menu control item 2.
Power Level	Same as menu control item 3.
Pulse Spacing →	
	P1-P2 Same as menu control item 4.
	P1-P3 Same as menu control item 4.
	P3-P4 Same as menu control item 4.
Pulse Width →	
	P1 Same as menu control item 5.
	P2 Same as menu control item 5.
	P3 Same as menu control item 5.
	P4 Same as menu control item 5.
Pulse Level →	
P1	VAR/CAL/OFF Same as menu control item 6.
P1	Power Deviation Same as menu control item 6.
P2	VAR/CAL/OFF Same as menu control item 6.
P2	Power Deviation Same as menu control item 6.
P3	VAR/CAL/OFF Same as menu control item 6.
P3	Power Deviation Same as menu control item 6.
P4	VAR/CAL/OFF Same as menu control item 6.
P4	Power Deviation Same as menu control item 6.
SLS	Same as menu control item 11.
Top/Bottom →	
	Power Deviation Same as menu control item 7.
	Time Same as menu control item 7.
Suppression Out	Same as menu control item 8.

3.1.3.6. Transponder Mode A/Mode S All-Call Menu

Figure 3.1.3.6.1 illustrates the TTG-7000 Transponder Mode A/Mode S All-Call Menu. The Transponder Mode A/Mode S All-Call Menu allows the user to setup the test set for Mode A/Mode S All-Call interrogations.

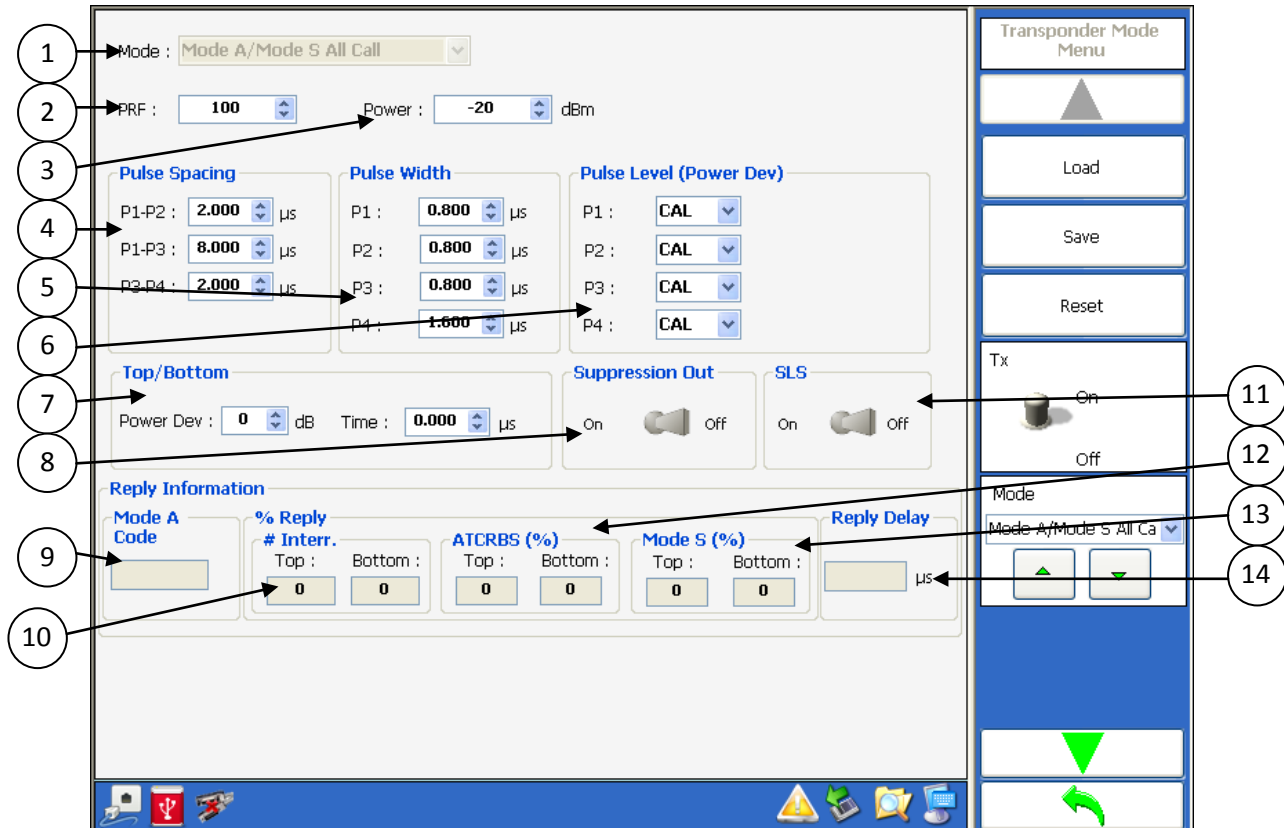

Figure 3.1.3.6.1 – Transponder Mode A/Mode S All Call Menu

Menu Control	Function
1	Interrogation mode
2	PRF. Range 1-2500 Hz.
3	Power. Range -20 to -90 dBm in 1 dB steps.
4	Pulse Spacing. P1-P2 (1-3 microseconds). P1-P3 (20.025-21.975 microseconds). P3-P4 (1-3 microseconds). Spacing steps in 0.025 microseconds.
5	Pulse Width. (0.025-1.950 microseconds). Steps in 0.025 microseconds.
6	Pulse Level. (CAL, VAR, OFF). Variable range +9 to -19 dB. All signals above -20 are limited to -20.
7	Top/Bottom settings. Time deviation +/- 0.975 microseconds in 0.025 microseconds

Menu Control	Function
	steps. Power deviation 0 to +5 dB in 1 dB steps.
8	Suppression Out. When enabled sends a suppression pulse on the Supp BNC.
9	Mode A code from reply.
10	Number of interrogations top and bottom antenna from last request.
11	SLS On/Off
12	Percent reply ATCRBS Top/Bottom.
13	Percent reply Mode S Top/Bottom.
14	Reply Delay

Softkey	Function
Default	Sets all settings on the screen to default Mode A\Mode S All-Call interrogation settings.
Tx On/Off	Turns on or off interrogations.
Mode	Same as menu control item 1.
PRF	Same as menu control item 2.
Power Level	Same as menu control item 3.
Pulse Spacing →	
	P1-P2 Same as menu control item 4.
	P1-P3 Same as menu control item 4.
	P3-P4 Same as menu control item 4.
Pulse Width →	
	P1 Same as menu control item 5.
	P2 Same as menu control item 5.
	P3 Same as menu control item 5.
	P4 Same as menu control item 5.
Pulse Level →	
	P1 VAR/CAL/OFF Same as menu control item 6.
	P1 Power Deviation Same as menu control item 6.
	P2 VAR/CAL/OFF Same as menu control item 6.
	P2 Power Deviation Same as menu control item 6.
	P3 VAR/CAL/OFF Same as menu control item 6.
	P3 Power Deviation Same as menu control item 6.
	P4 VAR/CAL/OFF Same as menu control item 6.
	P4 Power Deviation Same as menu control item 6.
SLS	Same as menu control item 11.
Top/Bottom →	
	Power Deviation Same as menu control item 7.
	Time Same as menu control item 7.
Suppression Out	Same as menu control item 8.

3.1.3.7. Transponder Mode C/Mode S All-Call Menu

Figure 3.1.3.7.1 illustrates the TTG-7000 Transponder Mode C/Mode S All-Call Menu. The Transponder Mode C/Mode S All-Call Menu allows the user to setup the test set for Mode C/Mode S All-Call interrogations.

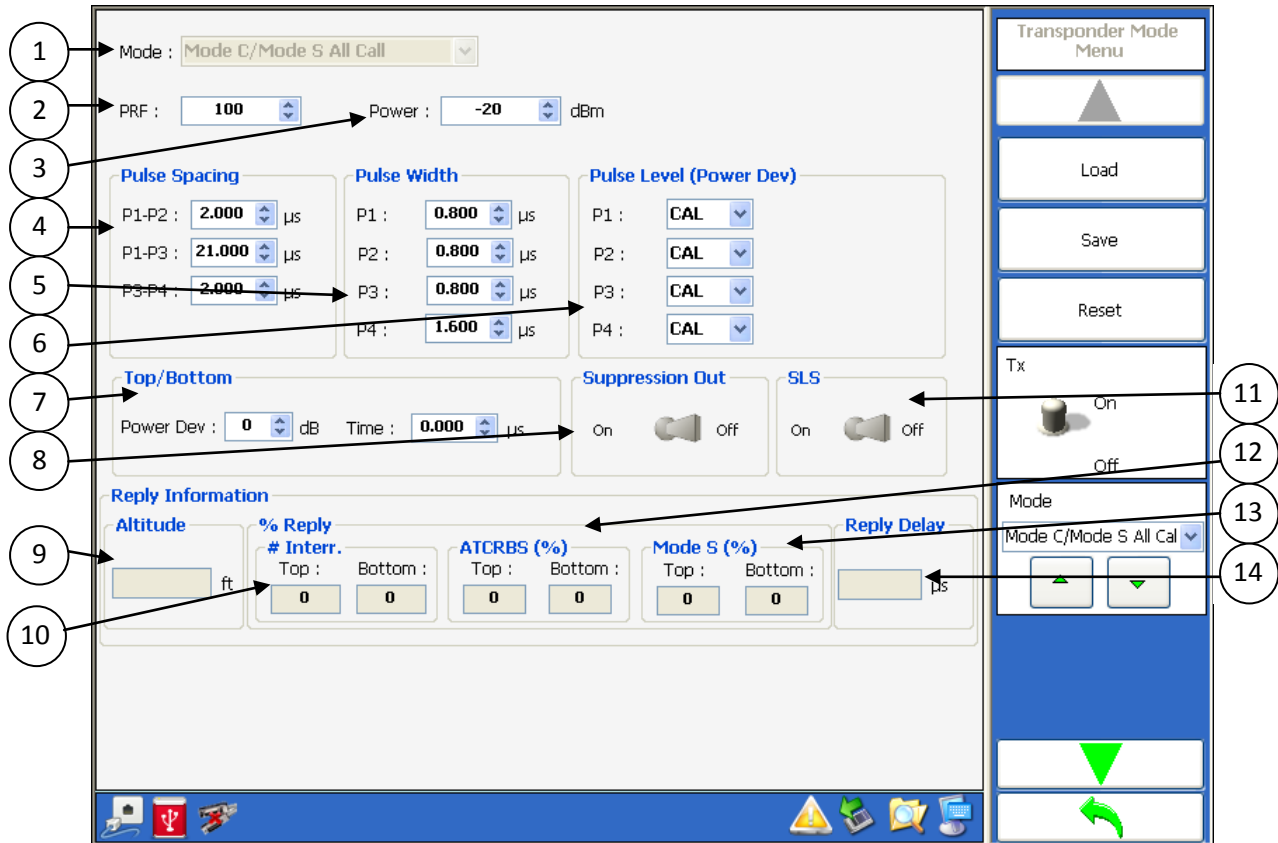

Figure 3.1.3.7.1 – Transponder Mode C/Mode S All-Call Menu

Menu Control	Function
1	Interrogation mode
2	PRF. Range 1-2500 Hz.
3	Power. Range -20 to -90 dBm in 1 dB steps.
4	Pulse Spacing. P1-P2 (1-3 microseconds). P1-P3 (20.025-21.975 microseconds). P3-P4 (1-3 microseconds). Spacing steps in 0.025 microseconds.
5	Pulse Width. (0.025-1.950 microseconds). Steps in 0.025 microseconds.
6	Pulse Level. (CAL, VAR, OFF). Variable range +9 to -19 dB. All signals above -20 are limited to -20.
7	Top/Bottom settings. Time deviation +/- 0.975 microseconds in 0.025 microseconds

Menu Control	Function
	steps. Power deviation 0 to +5 dB in 1 dB steps.
8	Suppression Out. When enabled sends a suppression pulse on the Supp BNC.
9	Mode C Altitude from reply.
10	Number of interrogations top and bottom antenna from last request.
11	SLS On/Off
12	Percent reply ATCRBS Top/Bottom.
13	Percent reply Mode S Top/Bottom.
14	Reply Delay

Softkey	Function
Default	Sets all settings on the screen to default Mode C/Mode S All-Call interrogation settings.
Tx On/Off	Turns on or off interrogations.
Mode	Same as menu control item 1.
PRF	Same as menu control item 2.
Power Level	Same as menu control item 3.
Pulse Spacing →	
	P1-P2 Same as menu control item 4.
	P1-P3 Same as menu control item 4.
	P3-P4 Same as menu control item 4.
Pulse Width →	
	P1 Same as menu control item 5.
	P2 Same as menu control item 5.
	P3 Same as menu control item 5.
	P4 Same as menu control item 5.
Pulse Level →	
	P1 VAR/CAL/OFF Same as menu control item 6.
	P1 Power Deviation Same as menu control item 6.
	P2 VAR/CAL/OFF Same as menu control item 6.
	P2 Power Deviation Same as menu control item 6.
	P3 VAR/CAL/OFF Same as menu control item 6.
	P3 Power Deviation Same as menu control item 6.
	P4 VAR/CAL/OFF Same as menu control item 6.
	P4 Power Deviation Same as menu control item 6.
SLS	Same as menu control item 11.
Top/Bottom →	
	Power Deviation Same as menu control item 7.
	Time Same as menu control item 7.
Suppression Out	Same as menu control item 8.

3.1.3.8. Transponder Mode S Menu

Figure 3.1.3.8.1 illustrates the TTG-7000 Transponder Mode S Menu.

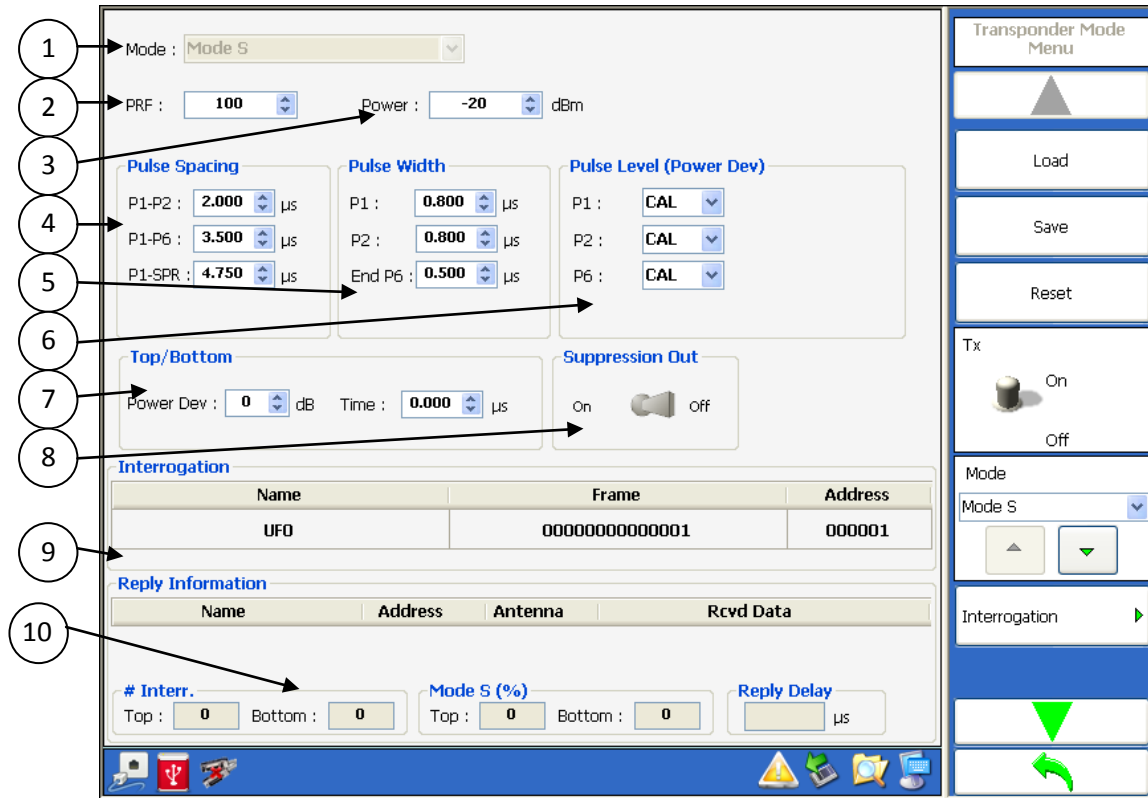

Figure 3.1.3.8.1 – Transponder Mode S Menu

Menu Control	Function
1	Interrogation mode
2	PRF. Range 1-2500 Hz.
3	Power. Range -20 to -90 dBm in 1 dB steps.
4	Pulse Spacing. P1-P2 (1-3 microseconds). P1-P6 (2.5-4.5 microseconds). P1-SPR (4.75 +/- 0.5 microseconds). Spacing steps in 0.025 microseconds.
5	Pulse Width. P1 and P2 (0.025-1.950 microseconds). The last 0.5 microsecond of P6 (0.025 – 1.950). Steps in 0.025 microseconds.
6	Pulse Level. (CAL, VAR, OFF). Variable range +9 to -19 dB. All signals above -20 are limited to -20.
7	Top/Bottom settings. Time deviation +/- 0.975 microseconds in 0.025 microseconds steps. Power deviation 0 to +5 dB in 1 dB steps.
8	Suppression Out. When enabled sends a suppression pulse on the Supp BNC.

Menu Control	Function
9	Interrogation
10	Reply Information

Softkey	Function
Default	Sets all settings on the screen to default Mode C/Mode S All-Call interrogation settings.
Tx On/Off	Turns on or off interrogations.
Mode	Same as menu control item 1.
PRF	Same as menu control item 2.
Power Level	Same as menu control item 3.
Pulse Spacing →	
	P1-P2 Same as menu control item 4.
	P1-P6 Same as menu control item 4.
	P1-SPR Same as menu control item 4.
Pulse Width →	
	P1 Same as menu control item 5.
	P2 Same as menu control item 5.
	End of P6 Same as menu control item 5.
Pulse Level →	
P1	VAR/CAL/OFF Same as menu control item 6.
P1	Power Deviation Same as menu control item 6.
P2	VAR/CAL/OFF Same as menu control item 6.
P2	Power Deviation Same as menu control item 6.
P6	VAR/CAL/OFF Same as menu control item 6.
P6	Power Deviation Same as menu control item 6.
Top/Bottom →	
	Power Deviation Same as menu control item 7.
	Time Same as menu control item 7.
Suppression Out	Same as menu control item 8.
Interrogation	Same as menu control item 9.

3.1.4 UAT Menu

Figure 3.1.4.1 illustrates the TTG-7000 UAT Menu. The UAT Menu allows the user to select between the Settings, Receiving Station, Receiver, or Scenario menus for UAT testing.

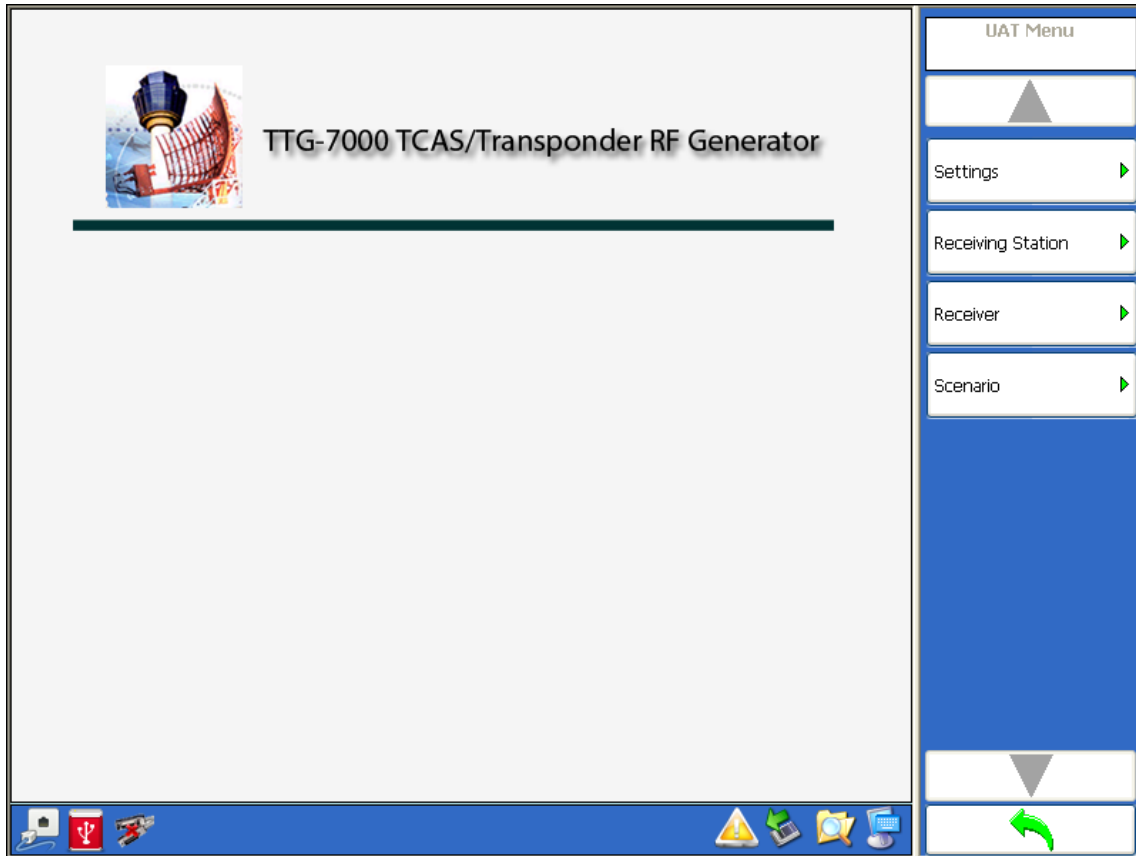

Figure 3.1.3.1 – Transponder Menu

Softkey	Function
Settings	Illustrates the UAT Settings Menu
Receiving Station	Illustrates the UAT Receiving Station Menu
Receiver Menu	Illustrates the UAT Receiver Menu
Scenario	Illustrates the UAT Scenario Menu

3.1.4.1. UAT Settings

Figure 3.1.4.1.1 illustrates the TTG-7000 UAT Settings Menu. The UAT Settings Menu allows the user to configure the Transmitter, Receiver, and Antenna Simulator modules within the test set for UAT tests. This menu is mainly used for testing and troubleshooting of the TTG-7000. For UAT unit testing, this menu should only be used to set the individual RF generator frequencies.

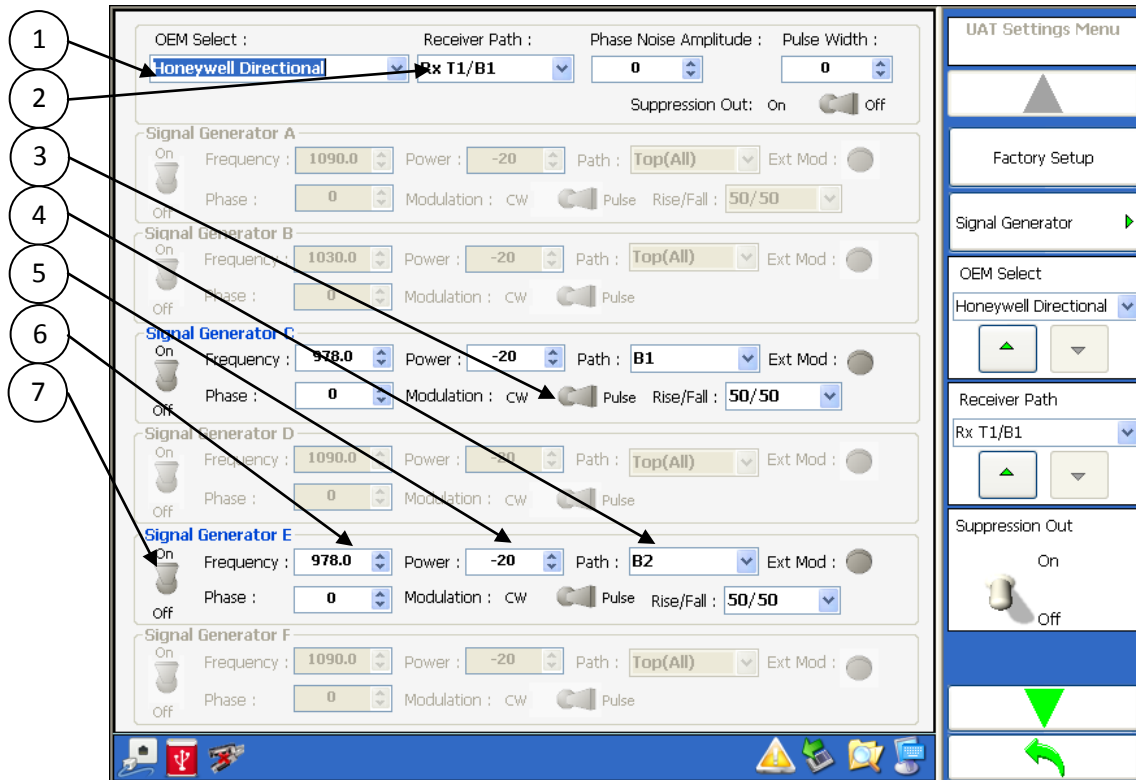

Figure 3.1.4.1.1 – UAT Settings Menu

Menu Control	Function
1	OEM Select Combobox allows the user to select the TCAS system OEM. The antenna resistors are set according to OEM selection. Also the calibration tables to emulate the bearing of intruders are loaded according to the OEM selection. OEM selections are Honeywell Directional, Honeywell Omni, Collins Phase Directional, Collins Phase Omni, ACSS Directional, ACSS Omni, Collins Magnitude Directional, Collins Magnitude Omni, Garmin or Avidyne.
2	Receiver Path Combobox allows the user to select which port to connect the Top/Bottom Receiver. Selections available are Rx T1/B1, Rx T2/B2, Rx T3/B3, Rx T4/B4, Chamber, or Combine.
3	Modulation CW/Pulse

Menu Control	Function
4	Tx Path allows setting the Tx path to Top All Ports/Bottom All Ports/Single Port. For UAT, UAT #1 is set to B1 port and UAT #2 is set to B2 port.
5	Tx Power Numeric Box allows the setting of the Transmitter power from -20 to -90 dBm in 1 dB steps.
6	Tx Frequency Numeric Box allows the setting of the Transmitter frequency. Individual setting for each transmitter. Range from 962 to 1213 MHz in 0.1 MHz steps.
7	Generator On/Off

Softkey	Function
Factory Setup	Sets all hardware to default setting according to hardware configuration.
Signal Generator Menu →	
Generator C →	
Signal On/Off	Same as menu control item 7.
Frequency	Same as menu control item 6.
Modulation	Same as menu control item 3.
Path	Same as menu control item 4.
Power	Same as menu control item 5.
Phase	Not Used.
Rise/Fall	Not Used.
Ext. Mod	Not Used.
Generator E	Same as Generator C.
Receiver Path	Same as menu control item 2.
Suppression Out On/Off	Future use.
OEM Select	Same as menu control item 1.
Phase Noise	Not used.
Pulsewidth	Not used.

3.1.4.2. UAT Receiver Menu

Figure 3.1.4.2.1 illustrates the TTG-7000 UAT Receiver Menu. The UAT Receiver Menu allows the user to view the transmissions from an UAT system and the transmissions from the TTG-7000 test set.

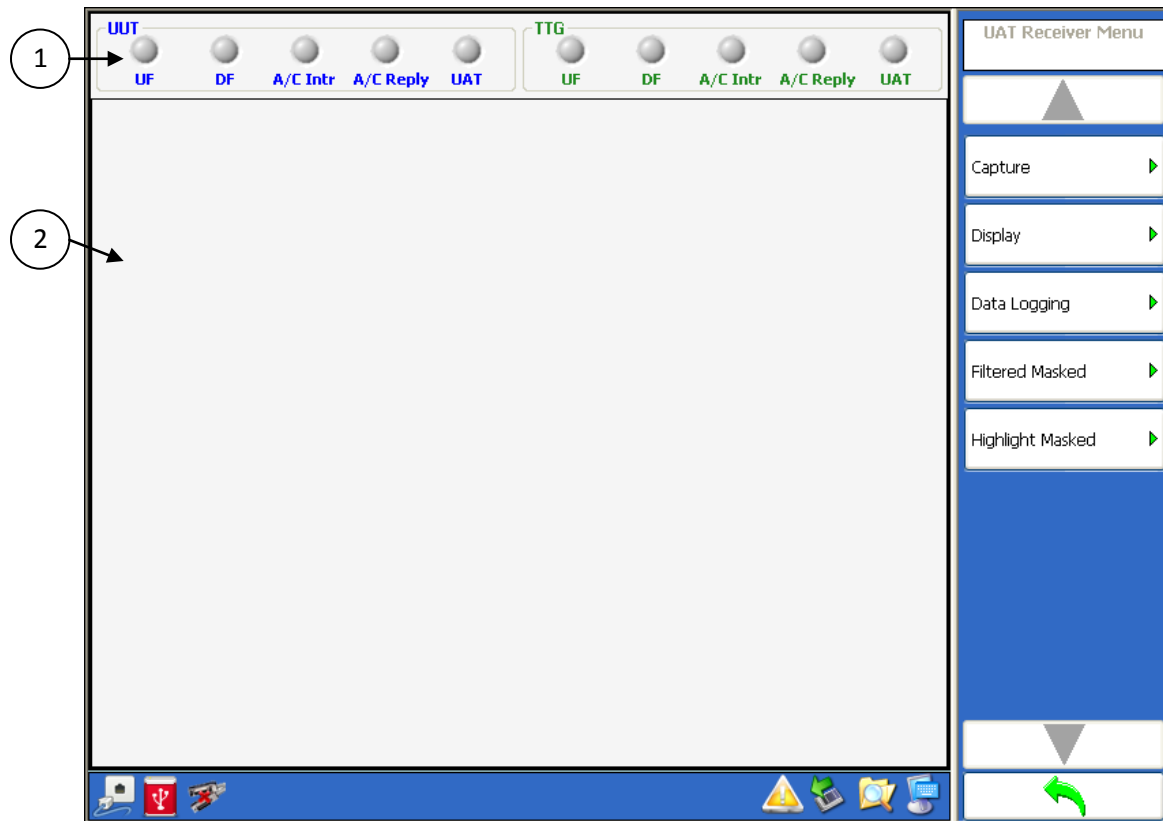

Figure 3.1.4.2.1 – TTG-7000 UAT Receiver Menu

Menu Control	Function
1	Top section of the Receiver Menu illustrates the status of reception from either the TCAS system under test or from the test set. There is a LED associated for the ATCRBS Reply, DF Reply, ATCRBS Interrogation, and UF Interrogation for the TCAS System (Rx Group) and the test set (Tx Group). For UAT option, LEDs are shown in the Rx and Tx group.
2	Reception section shows the last 8 receptions. Lines in blue represent receptions from the TCAS system. Lines in green represent receptions from the test set.

Softkey	Function
Capture→	
UUT DF	Enable/disable capture of Transponder DF messages.
TTG DF	Enable/disable capture of test set DF messages.
UUT UF	Enable/disable capture of TCAS UF messages.
TTG UF	Enable/disable capture of test set UF messages.
UUT ATCRBS Replies	Enable/disable capture of Transponder ATCRBS replies.
TTG ATCRBS Replies	Enable/disable capture of test set ATCRBS replies.
UUT ATCRBS Interrogation	Enable/disable capture of TCAS ATCRBS interrogations.
TTG ATCRBS Interrogation	Enable/disable capture of test set ATCRBS interrogations.
UUT UAT	Enable/disable capture of UAT messages (Optional).
TTG UAT	Enable/disable capture of UAT messages (Optional).
Display→	
Display	Allows turning on/off displaying new receptions.
Mode	
Update	Display data received by updating a message style with the latest reception.
Continuous	Display all data received in a continuous order by time.
Time	
Relative	Display time relative to previous message.
Absolute	Display the time received.
Clear	Clears all messages in the receiver menu.
Quantity to Show	Allows entering how many messages to show. (Maximum 1000 messages)
Refresh	Refreshes the receiver menu with the selected quantity of messages.
Frame Details	Illustrates the detail breakdown of a selected reception. See Figure 3.1.2.3.2. The detail breakdown of message can also be displayed, by turning off the Display softkey and double clicking on the desired message.
Data Logging→	
Record/Stop	Allows start and stopping data logging receive

Softkey	Function
Export Clear	messages. Allows exporting receive messages to file. Clears all recorded messages.
Filtered Masked Menu	
Highlight Masked Menu	

When performing an export the TTG-7000 generates a SDF (Compact Database File) and exports the file to the selected file location. The operator can download from ATG’s website a Reporting Tool that will display the contents of the SDF file and will allow the user to generate multiple CSV files from the exported data. Also all the DF17 position, velocity, and identification messages are decoded in the Reporting Tool.

3.1.4.3 UAT Receiving Station Menu

Figure 3.1.4.3.1 illustrates the TTG-7000 UAT Receiving Station Menu. The UAT Receiving Station allows the user to enter the Receiving Station position information.

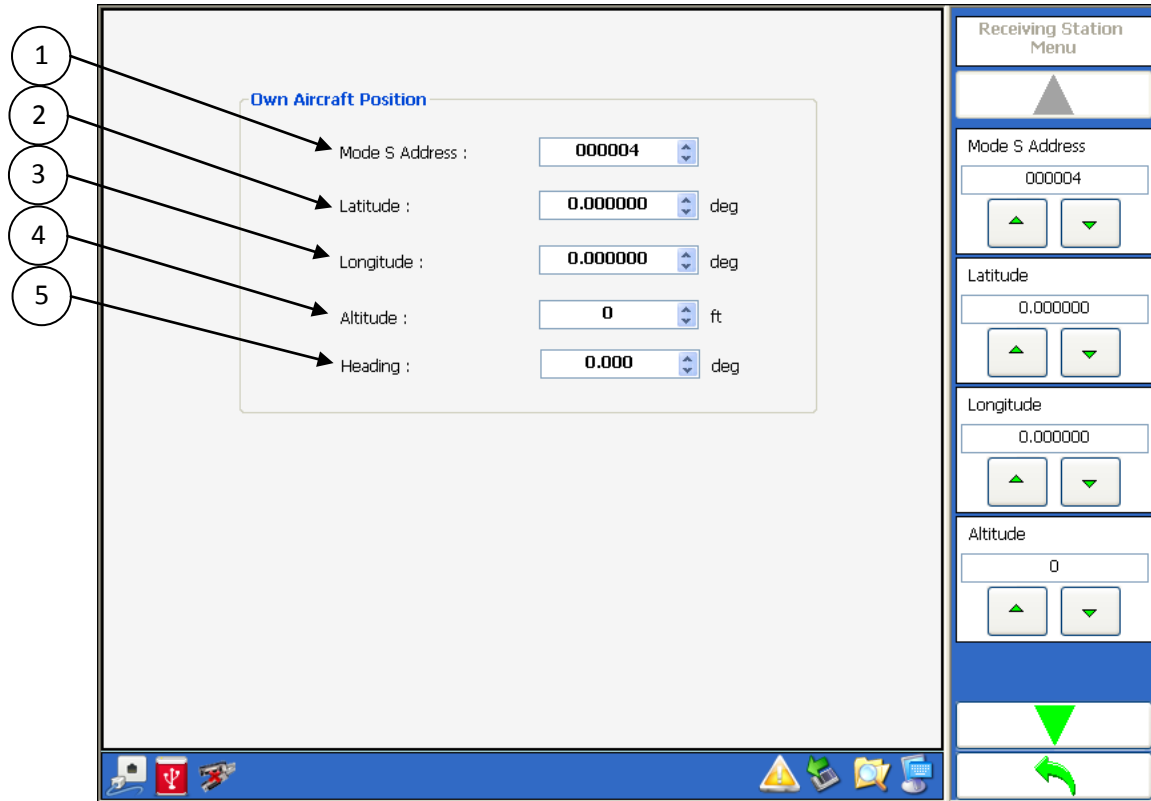

Figure 3.1.4.3.1 – TTG-7000 UAT Receiving Station Menu

Menu Control	Function
1	Mode S Address
2	Latitude of the receiving station. Range from -90 to 90 degrees.
3	Longitude of the receiving station. Range from -180 to 180 degrees.
4	Altitude of the receiving station. Range from -1000 to 65535 feet.
5	Heading of the receiving station. Range from -180 to 180 degrees.

Softkey	Function
Mode S Address	Same as menu control item 1.
Latitude	Same as menu control item 2.
Longitude	Same as menu control item 3.

Softkey	Function
Altitude	Same as menu control item 4.
Heading	Same as menu control item 5.

3.1.4.3. UAT Scenario Menu

Figure 3.1.4.4.1 illustrates the TTG-7000 UAT Scenario Menu. The UAT Scenario allows the user to define UAT scenario with static and dynamic targets.

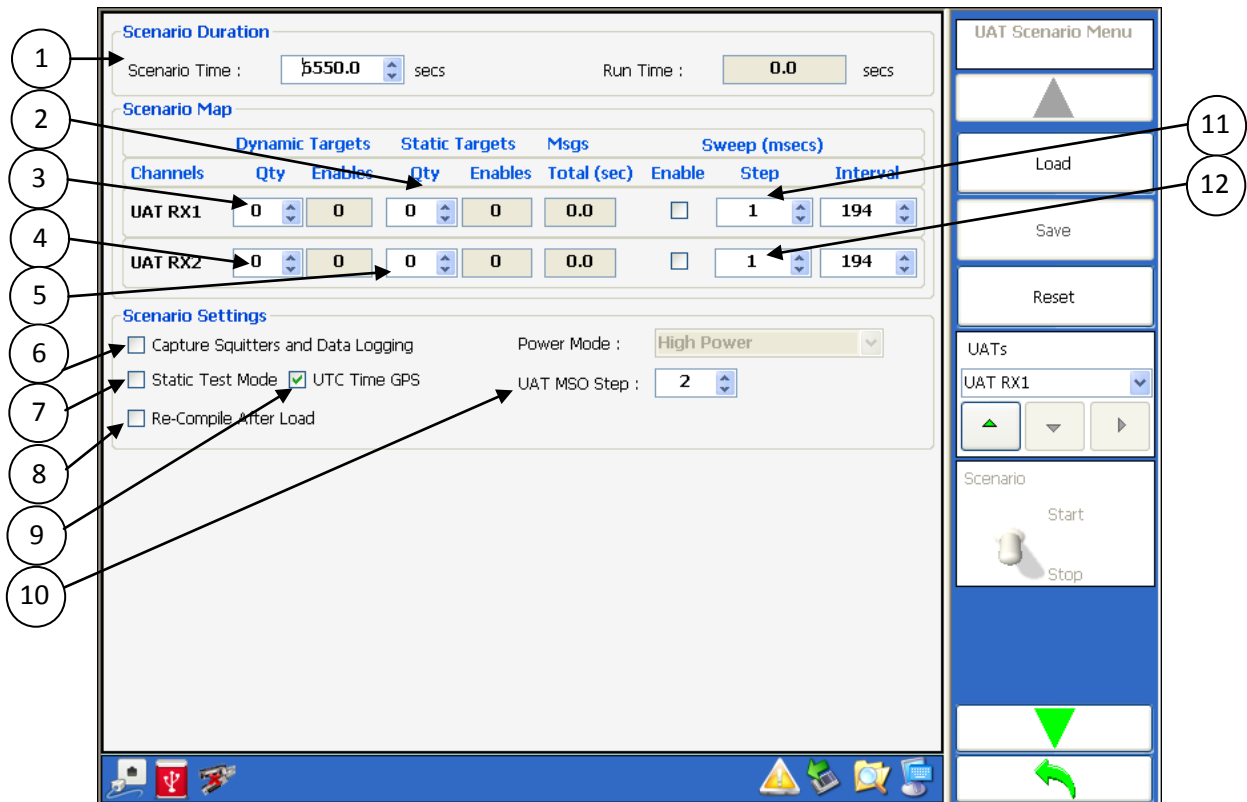

Figure 3.1.4.4.1 – TTG-7000 UAT Scenario Menu

Menu Control	Function
1	Scenario Time. Range 0 to 6550 seconds.
2	Static Targets for UAT#1 defined and enabled.
3	Dynamic Targets for UAT#1 defined and enabled.
4	Dynamic Targets for UAT#2 defined and enabled.
5	Static Targets for UAT#1 defined and enabled.
6	Capture Squitters and Data Logging. If enabled will clear log file when scenario starts and start capturing new messages.
7	Static Test Mode. Targets are active at the end of scenario time at their last position.
8	Re-Compile After Load. Compiles all messages for the different targets after loading a

Menu Control	Function
	saved file.
9	UTC Time GPS. If enabled uses the UTC time from the GPS source input on external I/O BNC #3. If disabled, the Touchscreen provides the DSP and FPGA with the UTC time.
10	UAT MSO Steps. The separation between UAT messages.
11	Sweep Control for UAT#1. If enabled then the UAT messages will change every second by the sweep step until the MSO reaches the interval.
12	Sweep Control for UAT#2. If enabled then the UAT messages will change every second by the sweep step until the MSO reaches the interval.

Softkey	Function
Load	Loads a scenario.
Save	Saves a scenario.
Reset	Resets the scenario menu.
UATs→	Illustrates the target definition for selected UAT transmitter.
Scenario Start/Stop	Allows starting and stopping a scenario.
Scenario Time	Same as menu control item 1.
UAT RX1 Dynamics	Number of Dynamic targets in UAT#1
UAT RX1 Statics	Number of Static targets in UAT#1
UAT RX1 Sweep	UAT#1 Sweep Enable
UAT RX1 Sweep Rate	UAT#1 Sweep Step in milliseconds
UAT RX1 Sweep Interval	UAT#1 Sweep Stop in milliseconds
UAT RX2 Dynamics	Number of Dynamic targets in UAT#2
UAT RX2 Statics	Number of Static targets in UAT#2
UAT RX2 Sweep	UAT#2 Sweep Enable
UAT RX2 Sweep Rate	UAT#2 Sweep Step in milliseconds
UAT RX2 Sweep Interval	UAT#2 Sweep Stop in milliseconds
Capture	Same as menu control item 6.
Static Test Mode	Same as menu control item 7.
UTC Time GPS	Same as menu control item 9.
UAT MSO Steps	Same as menu control item 10.
Re-Compile After Load	Same as menu control item 8.

Note: When defining targets automatically the Touchscreen software starts at MSO 752 and spaces the targets at the specified MSO steps.

Note: In order to transmit UAT messages and the runtime to function after a start of scenario, the TTG-7000 needs the PPS signal from the GPS on external I/O #1 to function. User can also provide a 1 Hz signal on external I/O #1.

3.1.4.4.1 UAT Target Definition Menu

Figure 3.1.4.4.1.1 illustrates the TTG-7000 Target Definition Menu. The UAT Scenario allows the user to define UAT scenario with static and dynamic targets.

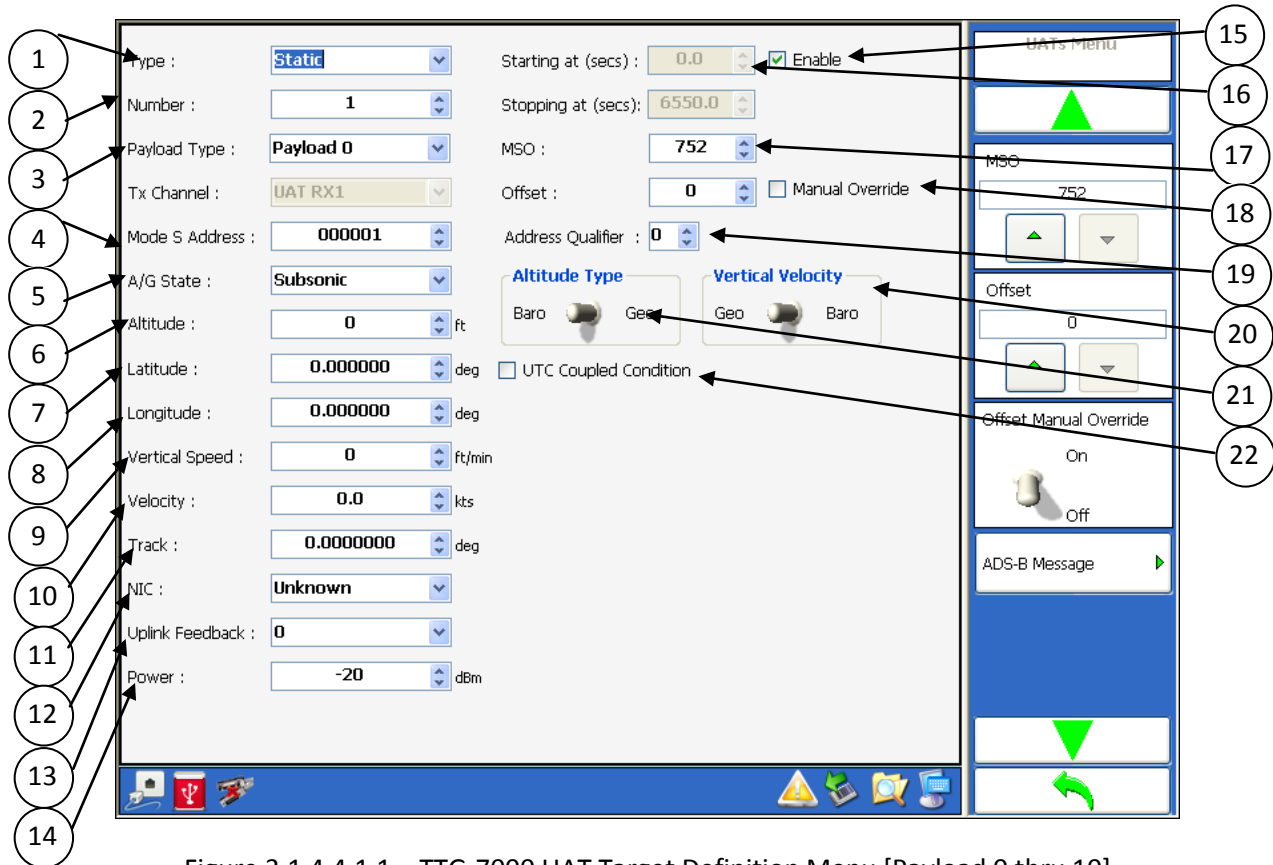

Figure 3.1.4.4.1.1 – TTG-7000 UAT Target Definition Menu [Payload 0 thru 10]

Menu Control	Function
1	Target Type. Static or Dynamic
2	Target Number
3	Payload Type. Payload 0 thru 10, Basic ADS-B, Long ADS-B, or Ground Uplink
4	Mode S Address
5	A/G State. [Subsonic, Supersonic, Grounded, Reserved]
6	Altitude. Range from -1000 to 101350 feet.
7	Latitude. Range +/-90 degrees
8	Longitude. Range +/- 180 degrees.
9	Vertical Speed. Range +/- 32704 feet/minute
10	Velocity. Range 0 to 1446 knots
11	Track. Range +/- 180 degrees

Menu Control	Function
12	NIC
13	Uplink Feedback
14	Power. Range +1 to -98 dBm
15	Enable. If check, the target is enabled.
16	Start and Stop Times. For dynamic targets, the time when the target is operational.
17	MSO. The target MSO transmission slot.
18	Offset and Override. If override is disabled, the offset is calculated between the target latitude and longitude and the receiving station latitude and longitude. If override is enabled, the calculated offset is replaced by the offset entered.
19	Address Qualifier
20	Vertical Velocity. [Geometric or Barometric]
21	Altitude Type. [Barometric or Geometric]
22	UTC Coupled.

Softkey	Function
Type	Same as menu control item 1.
Target Number	Same as menu control item 2.
Enable	Same as menu control item 15.
Payload Type	Same as menu control item 3.
MSO	Same as menu control item 17.
Offset	Same as menu control item 18.
Offset Manual Override	Same as menu control item 18.
ADS-B Message →	Illustrate UAT ADS-B Message Menu

Figure 3.1.4.4.1.2 illustrates the TTG-7000 UAT ADS-B Message Menu.

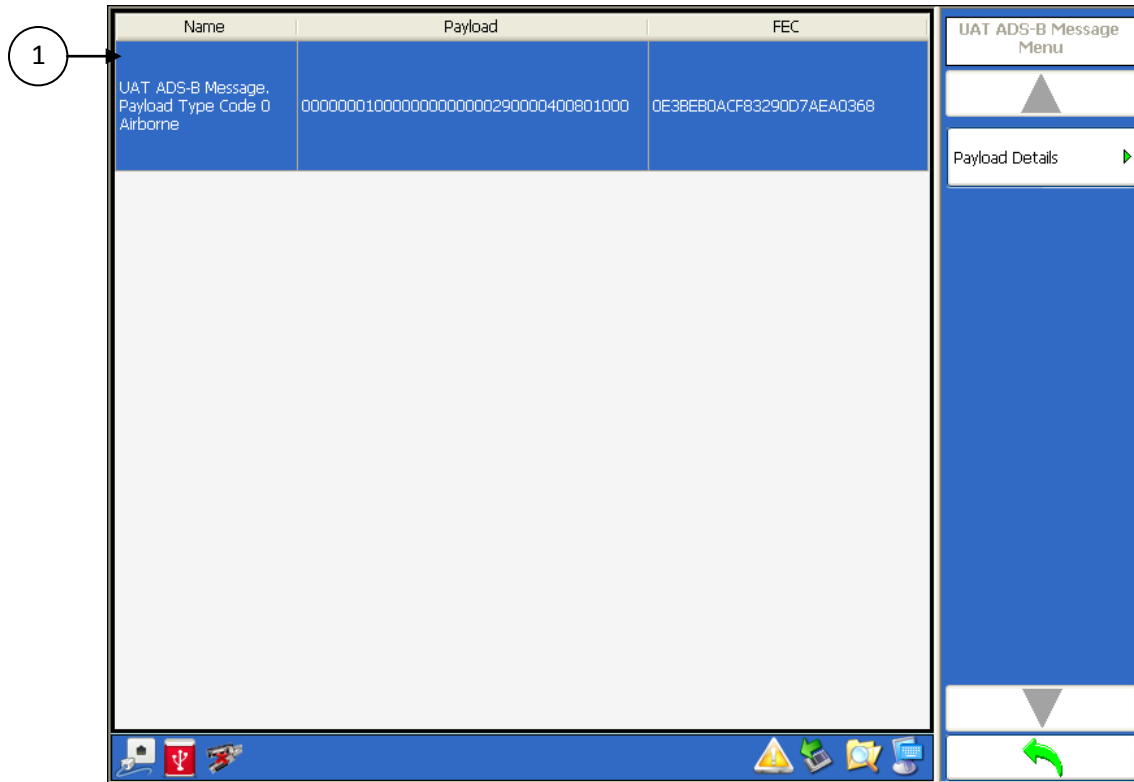

Figure 3.1.4.4.1.2 – TTG-7000 UAT ADS-B Message Menu

Menu Control	Function
1	Message Name, Payload and FEC

Softkey	Function
Payload Details →	Illustrates UAT Payload Fields Menu

Figure 3.1.4.4.1.3 illustrates the TTG-7000 UAT Payload Fields Menu.

Name	Value	Units	LSB	Description	Low	High	Invalid
Payload Type	0	N/A	1	Payload type	0	31	False
Address qualifier	0	N/A	1	Address qualifier	0	7	False
Address	000001	N/A	1	Address	000000	16777216	False
Latitude	0.000000	deg	2.1457672E-	23 bit coded latitude	-90	90	False
Longitude	0.000000	deg	2.1457672E-	24 bit coded latitude	-180	180	False
Altitude type	0	N/A	0	0 =Pressure Altitude and 1 = Geometric	0	1	False
Altitude	0	ft	25	12 bit coded (altitude-1000	-1000	101350	False
NIC	Unknown	NM or m	0	Radius of containment	0	15	False
A/G state	0	N/A	0	0 = Subsonic, 1 =	0	3	False

UAT Payload Fields Menu

▲

Payload Type

0

▲ ▼

Address qualifier

0

▲ ▼

Address

000001

▲ ▼

▼

↶

Figure 3.1.4.4.1.3 – TTG-7000 UAT Payload Fields Menu

Figure 3.1.4.4.1.4 illustrates the TTG-7000 UAT Menu for either a Basic ADS-B or Long ADS-B. This menu allows the user to enter the hexadecimal data for the message and FEC portions of the ADS-B message.

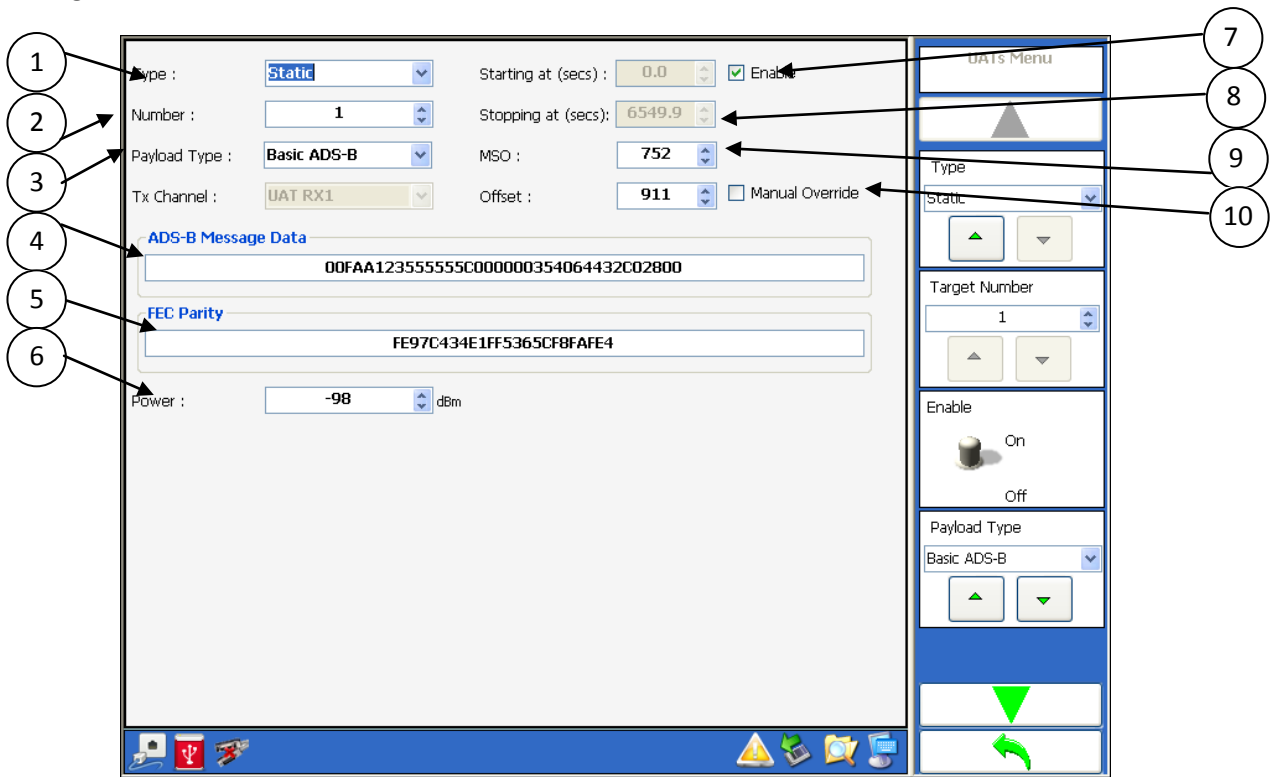

Figure 3.1.4.4.1.4 – TTG-7000 UAT Target Definition Menu [Basic and Long ADS-B]

Menu Control	Function
1	Target Type. Static or Dynamic
2	Target Number
3	Payload Type. Payload 0 thru 10, Basic ADS-B, Long ADS-B, or Ground Uplink
4	ADS-B Message Data.
5	FEC Parity Data
6	Power. Range +1 to -98 dBm
7	Enable. If check, the target is enabled.
8	Start and Stop Times. For dynamic targets, the time when the target is operational.
9	MSO. The target MSO transmission slot.
10	Offset and Override. If override is disabled, the offset is calculated between the target latitude and longitude and the receiving station latitude and longitude. If override is enabled, the calculated offset is replace by the offset entered.

Softkey	Function
Type	Same as menu control item 1.
Target Number	Same as menu control item 2.
Enable	Same as menu control item 7.
Payload Type	Same as menu control item 3.
MSO	Same as menu control item 9.
Offset	Same as menu control item 10.
Offset Manual Override	Same as menu control item 10.
ADS-B Message Data	Same as menu control item 4.
FEC Parity	Same as menu control item 5.
FEC Calculator	Calculates the correct FEC Parity for the ADS-B data entered.
Power	Same as menu control item 6.

Figure 3.1.4.4.1.5 illustrates the TTG-7000 UAT Menu for a Ground Uplink message.

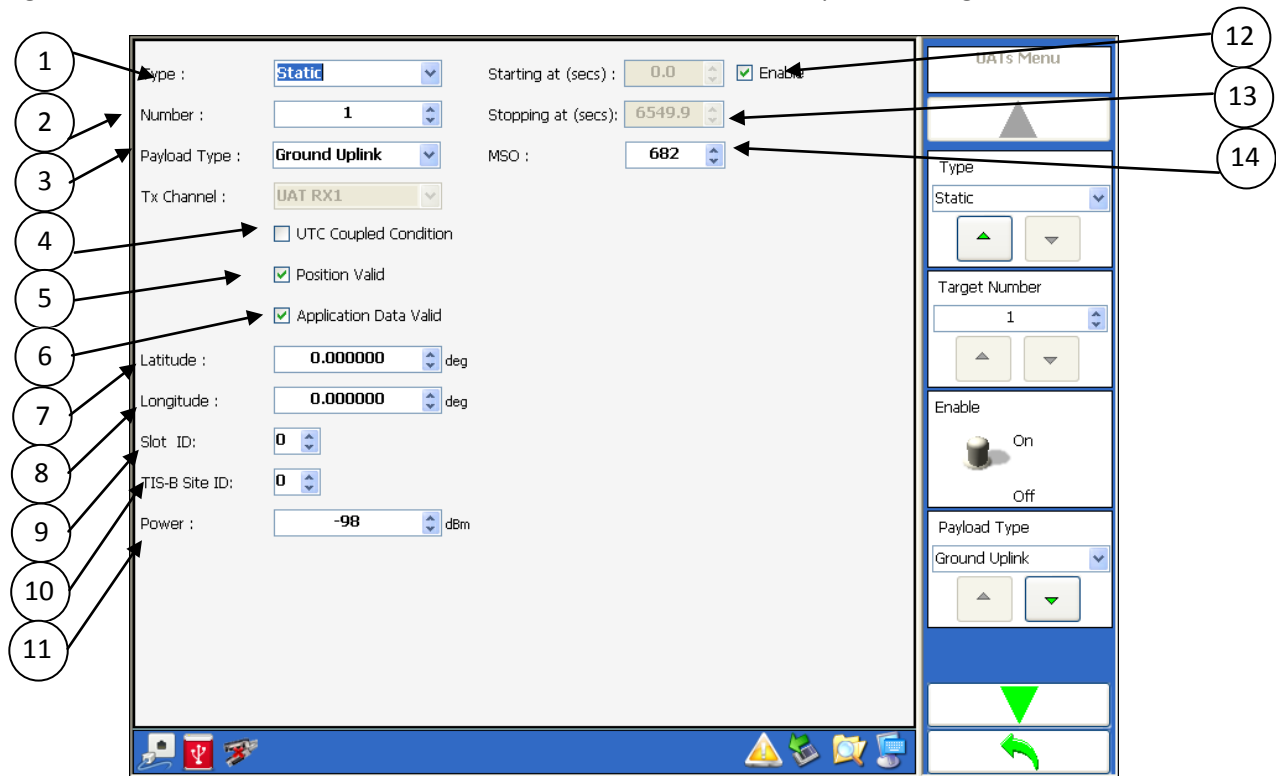

Figure 3.1.4.4.1.5 – TTG-7000 UAT Target Definition Menu [Ground Uplink]

Menu Control	Function
1	Target Type. Static or Dynamic
2	Target Number
3	Payload Type. Payload 0 thru 10, Basic ADS-B, Long ADS-B, or Ground Uplink
4	UTC Coupled
5	Position Valid
6	Application Data Valid
7	Latitude
8	Longitude
9	Slot ID
10	TIS-B Site ID
11	Power. Range +1 to -98 dBm
12	Enable. If check, the target is enabled.
13	Start and Stop Times. For dynamic targets, the time when the target is operational.
14	MSO. The target MSO transmission slot.

Softkey	Function
Type	Same as menu control item 1.
Target Number	Same as menu control item 2.
Enable	Same as menu control item 12.
Payload Type	Same as menu control item 3.
MSO	Same as menu control item 14.
Ground Uplink Message →	Illustrates Ground Uplink Message Menu
UTC Coupled	Same as menu control item 4.
Position Valid	Same as menu control item 5.
Application Data Valid	Same as menu control item 6.
Slot ID	Same as menu control item 9.
TIS-B Site ID	Same as menu control item 10.
Latitude	Same as menu control item 7.
Longitude	Same as menu control item 8.
Power	Same as menu control item 11.

3.2. How to ...

3.2.1. How to Change GPIB Address

1. Go to the TTG-7000 [Main Menu](#)
2. Press the **System Menu** softkey to display [System Menu](#).
3. Change the GPIB address using the **GPIB Address** combobox or select **GPIB Menu** softkey and then use the **GPIB Address** softkey. Once the address is changed, the new address is stored and will be used until changed again.

3.2.2. How to Change Transmitter Frequency

1. Go to the TTG-7000 [Main Menu](#)
2. Press the **TCAS** softkey to display [TCAS Main Menu](#).
3. Press the **Settings** softkey to display the [TCAS Settings Menu](#).
4. Change the frequency of the appropriate transmitter generator using the **Frequency** combobox or select **Signal Generator** softkey, appropriate transmitter generator softkey and then use the **Frequency** softkey.

3.2.3. How to Set a Scope Output

1. Go to the TTG-7000 [Main Menu](#)
2. Select the **System Menu** softkey to display [System Menu](#).
3. Change the output by using the **Scope 1 or Scope 2** combobox or using **Scope 1 or Scope 2** softkey.

3.2.4. How to Program DSP Software or FPGA Firmware

1. Go to the TTG-7000 [Main Menu](#)
2. Press the **System Menu** softkey to display [System Menu](#).
3. Press the **Software Update** softkey to display the [Software Update Menu](#).
4. Press the **Select** softkey to display the file dialog to select the configuration file that will be used for programming.

5. If all devices enabled in the configuration file are to be programmed, then press the **Execute** softkey to start programming. If some devices do not require reprogramming deselect the device under the Programming column and then press the **Execute** softkey to start programming.
6. During programming sequence the device being programmed will be highlighted in the table and a progress bar will be displayed in the lower section of the menu.
7. After programming is completed it is recommended to restart the system. To restart the system press the power switch allow power to turn off and press the power switch again to power up the test set.

3.2.5. How to Install the TTG-7000C RF Amplifier

1. Turn off power of the TTG-7000 by pressing the power switch on the front of the test set.
2. Connect the 25 pin ribbon cable provided with the TTG-7000C from the rear of the TTG-7000C Aux Control port to the TTG-7000 Aux Control port.
3. Match the RF ports on the front of the TTG-7000C with the RF ports on the front of the TTG-7000 using the RF cables provided with the TTG-7000C.
4. Connect the RF cables from chamber to the TTG-7000C RF ports on the rear.
5. Turn on power of the TTG-7000 by pressing the power switch on the front of the test set. The TTG-7000 provides power to the TTG-7000C, therefore the power indicator on the TTG-7000C should be illuminated once power is applied to the TTG-7000.

3.2.6. How to Enter Own Aircraft Information

1. Go to the TTG-7000 [Main Menu](#)
2. Press the **TCAS** softkey to display [TCAS Main Menu](#).
3. Press the **Own Aircraft** softkey to display the [TCAS Own Aircraft Menu](#).
4. Use the comboboxes or softkeys on the [TCAS Own Aircraft Menu](#) to enter the appropriate information.

3.2.7. How to Setup a Static ATCRBS Intruder

1. Go to the TTG-7000 [Main Menu](#)
2. Press the **TCAS** softkey to display [TCAS Main Menu](#).
3. Press the **Scenario** softkey to display the [TCAS Scenario Menu](#).
4. Use the **Scenario Time** combobox or softkey to enter the scenario time.

5. Set the number of static intruders to at least 1 using either the **Number of Static Intruders** combobox or softkey.
6. Press the **Intruders** softkey to edit the intruder information. Select Mode C in the **Intruder Mode** combobox or softkey to display the [Static Mode C Menu](#).
7. Use the controls on [Static Mode C Menu](#) to enter the information for your ATCRBS intruder.

Static Mode C Minimum Parameters		
Parameter	Default	Selection (Range)
Tx Channel	Gen A	Gen A, Gen C, or Gen D
Altitude	1000	-1000 to 126700 feet
Bearing	0	0 to 359 degrees
Range	0	0 to 160 Nmi
Latitude		-90 to 90 degrees
Longitude		-180 to 180 degrees
Reply Power	-20	-20 to -90 dBm (Low Power) 1 to -69 dBm (Hi Power)
Start at	0	0 to Scenario Duration
Stop at	Scenario Duration	0 to Scenario Duration
Enable	Enable	Enable/Disable
Reply	On	On/Off
Altitude Reporting	On	On/Off
WS1	0	0-255
WS2	0	0-255
Reply Antenna (WS1)	By Altitude	Bottom, Top, Both, By Altitude
Reply Antenna (WS2)	By Altitude	Bottom, Top, Both, By Altitude
Reply Quadrant (WS1)	Forward	Forward, Right, After, Left, Any Quadrant, By Location
Reply Quadrant (WS2)	Forward	Forward, Right, After, Left, Any Quadrant, By Location
Mode A Code	0000	0000-7777 (Octal)

Note: That for all intruders the location can be entered using range and bearing or latitude and longitude. If range and bearing is used the TTG-7000 will calculate the latitude and longitude of the intruder. If latitude and longitude is being used the TTG-7000 will calculate the range and bearing from the own aircraft.

8. When all the required information is entered press the **Back** softkey on the bottom of the softkey area to return to the [TCAS Scenario Menu](#).
9. To start the scenario use the **Scenario** softkey. Once the scenario has started the **Run Time** box on the top of the menu should be changing with the current scenario time.

10. If the scenario terminates, the **Scenario** softkey will return to the off position. If user wants to terminate the scenario before the total scenario time, change the **Scenario** softkey to the off position.

3.2.8. How to Setup a Dynamic ATCRBS Intruder

1. Go to the TTG-7000 [Main Menu](#)
2. Press the **TCAS** softkey to display [TCAS Main Menu](#).
3. Press the **Scenario** softkey to display the [TCAS Scenario Menu](#).
4. Use the **Scenario Time** combobox or softkey to enter the scenario time.
5. Set the number of dynamic intruders to at least 1 using either the **Number of Dynamic Intruders** combobox or softkey.
6. Press the **Intruders** softkey to edit the intruder information. Select Mode C in the **Intruder Mode** combobox or softkey to display the [Dynamic Mode C Menu](#).
7. Use the controls on [Dynamic Mode C Menu](#) to enter the information for your ATCRBS intruder. This screen is similar to the static, but allows the user to enter a velocity, vertical speed, and track direction.

Dynamic Mode C Minimum Parameters		
Parameter	Default	Selection (Range)
Tx Channel	Gen A	Gen A, Gen C, or Gen D
Altitude	1000	-1000 to 126700 feet
Bearing	0	0 to 359 degrees
Range	0	0 to 160 Nmi
Latitude		-90 to 90 degrees
Longitude		-180 to 180 degrees
Velocity	0	0 to 2000 knots
Vertical Speed	0	+/- 32576 ft/min
Track	0	-180 to 180 degrees
Reply Power	-20	-20 to -90 dBm (Low Power) 1 to -69 dBm (Hi Power)
Start at	0	0 to Scenario Duration
Stop at	Scenario Duration	0 to Scenario Duration
Enable	Enable	Enable/Disable
Reply	On	On/Off
Altitude Reporting	On	On/Off
WS1	0	0-255
WS2	0	0-255

Reply Antenna (WS1)	By Altitude	Bottom, Top, Both, By Altitude
Reply Antenna (WS2)	By Altitude	Bottom, Top, Both, By Altitude
Reply Quadrant (WS1)	Forward	Forward, Right, After, Left, Any Quadrant, By Location
Reply Quadrant (WS2)	Forward	Forward, Right, After, Left, Any Quadrant, By Location
Mode A Code	0000	0000-7777 (Octal)

Note: That for all intruders the location can be entered using range and bearing or latitude and longitude. If range and bearing is used the TTG-7000 will calculate the latitude and longitude of the intruder. If latitude and longitude is being used the TTG-7000 will calculate the range and bearing from the own aircraft.

8. When all the required information is entered press the **Back** softkey on the bottom of the softkey area to return to the [TCAS Scenario Menu](#).
9. To start the scenario use the **Scenario** softkey. Once the scenario has started the **Run Time** box on the top of the menu should be changing with the current scenario time.
10. If the scenario terminates, the **Scenario** softkey will return to the off position. If user wants to terminate the scenario before the total scenario time, change the **Scenario** softkey to the off position.

3.2.9. How to Setup a Static Mode S Intruder

1. Go to the TTG-7000 [Main Menu](#)
2. Press the **TCAS** softkey to display [TCAS Main Menu](#).
3. Press the **Scenario** softkey to display the [TCAS Scenario Menu](#).
4. Use the **Scenario Time** combobox or softkey to enter the scenario time.
5. Set the number of static intruders to at least 1 using either the **Number of Static Intruders** combobox or softkey.
6. Press the **Intruders** softkey to edit the intruder information. Select Mode S TCAS Only in the **Intruder Mode** combobox or softkey to display the [Static Mode S Menu](#).
7. Use the controls on [Static Mode S Menu](#) to enter the information for your Mode S intruder.

Static Mode S Minimum Parameters		
Parameter	Default	Selection (Range)
Tx Channel	Gen A	Gen A, Gen C, or Gen D
Altitude	1000	-1000 to 126700 feet
Bearing	0	0 to 359 degrees
Range	0	0 to 160 Nmi

Latitude		-90 to 90 degrees
Longitude		-180 to 180 degrees
Reply Power	-20	-20 to -90 dBm (Low Power) 1 to -69 dBm (Hi Power)
Reply Antenna	By Altitude	Bottom, Top, Both, Alternating, By Altitude
Squitter Power	-50	-20 to -90 dBm (Low Power) 1 to -69 dBm (Hi Power)
Squitter Antenna	Both	Top, Bottom, Both
Start at	0	0 to Scenario Duration
Stop at	Scenario Duration	0 to Scenario Duration
Enable	Enable	Enable/Disable
Reply	On	On/Off
Squitter	On	On/Off
Ground	Off	On/Off
Crosslink Capability	Off	On/Off
Mode S Address		0 – FFFFFFF
Altitude Code Mode	Binary	Binary, Gilham
Reply Probability	1	0, 0.2, 0.4, 0.6, 0.8, 1
Squitter Probability	1	0, 0.2, 0.4, 0.6, 0.8, 1
Mode A Code	0000	0000-7777 (Octal)
CA	0	0-7
FS	0	0-7
DR	0	0-31
UM	0	0-63
SL	No TCAS Sensitivity Level	0-7
RI (AQ=0)	No on board TCAS	0-7
RI(AQ=1)	No Airspeed	0-7

Note: That for all intruders the location can be entered using range and bearing or latitude and longitude. If range and bearing is used the TTG-7000 will calculate the latitude and longitude of the intruder. If latitude and longitude is being used the TTG-7000 will calculate the range and bearing from the own aircraft.

8. When all the required information is entered press the **Back** softkey on the bottom of the softkey area to return to the [TCAS Scenario Menu](#).
9. To start the scenario use the **Scenario** softkey. Once the scenario has started the **Run Time** box on the top of the menu should be changing with the current scenario time.

10. If the scenario terminates, the **Scenario** softkey will return to the off position. If user wants to terminate the scenario before the total scenario time, change the **Scenario** softkey to the off position.

3.2.10. How to Setup a Dynamic Mode S Intruder

1. Go to the TTG-7000 [Main Menu](#).
2. Press the **TCAS** softkey to display [TCAS Main Menu](#).
3. Press the **Scenario** softkey to display the [TCAS Scenario Menu](#).
4. Use the **Scenario Time** combobox or softkey to enter the scenario time.
5. Set the number of dynamic intruders to at least 1 using either the **Number of Dynamic Intruders** combobox or softkey.
6. Press the **Intruders** softkey to edit the intruder information. Select Mode S TCAS Only the **Intruder Mode** combobox or softkey to display the [Dynamic Mode S Menu](#).
7. Use the controls on [Dynamic Mode S Menu](#) to enter the information for your Mode S intruder. This screen is similar to the static, but allows the user to enter a velocity, vertical speed, and track direction.

Dynamic Mode S Minimum Parameters		
Parameter	Default	Selection (Range)
Tx Channel	Gen A	Gen A, Gen C, or Gen D
Altitude	1000	-1000 to 126700 feet
Bearing	0	0 to 359 degrees
Range	0	0 to 160 Nmi
Latitude		-90 to 90 degrees
Longitude		-180 to 180 degrees
Velocity	0	0 to 2000 knots
Vertical Speed	0	+/- 32576 ft/min
Track	0	-180 to 180 degrees
Reply Power	-20	-20 to -90 dBm (Low Power) 1 to -69 dBm (Hi Power)
Reply Antenna	By Altitude	Bottom, Top, Both, Alternating, By Altitude
Squitter Power	-50	-20 to -90 dBm (Low Power) 1 to -69 dBm (Hi Power)
Squitter Antenna	Both	Top, Bottom, Both
Start at	0	0 to Scenario Duration

Stop at	Scenario Duration	0 to Scenario Duration
Enable	Enable	Enable/Disable
Reply	On	On/Off
Squitter	On	On/Off
Ground	Off	On/Off
Crosslink Capability	Off	On/Off
Mode S Address		0 – FFFFFFF
Altitude Code Mode	Binary	Binary, Gilham
Reply Probability	1	0, 0.2, 0.4, 0.6, 0.8, 1
Squitter Probability	1	0, 0.2, 0.4, 0.6, 0.8, 1
Mode A Code	0000	0000-7777 (Octal)
CA	0	0-7
FS	0	0-7
DR	0	0-31
UM	0	0-63
SL	No TCAS Sensitivity Level	0-7
RI (AQ=0)	No on board TCAS	0-7
RI(AQ=1)	No Airspeed	0-7

Note: That for all intruders the location can be entered using range and bearing or latitude and longitude. If range and bearing is used the TTG-7000 will calculate the latitude and longitude of the intruder. If latitude and longitude is being used the TTG-7000 will calculate the range and bearing from the own aircraft.

8. When all the required information is entered press the **Back** softkey on the bottom of the softkey area to return to the [TCAS Scenario Menu](#).
9. To start the scenario use the **Scenario** softkey. Once the scenario has started the **Run Time** box on the top of the menu should be changing with the current scenario time.
10. If the scenario terminates, the **Scenario** softkey will return to the off position. If user wants to terminate the scenario before the total scenario time, change the **Scenario** softkey to the off position.

3.2.11. How to Setup a Static Mode S Extended Intruder

1. Go to the TTG-7000 [Main Menu](#)
2. Press the **TCAS** softkey to display [TCAS Main Menu](#).
3. Press the **Scenario** softkey to display the [TCAS Scenario Menu](#).
4. Use the **Scenario Time** combobox or softkey to enter the scenario time.

5. Set the number of static intruders to at least 1 using either the **Number of Static Intruders** combobox or softkey.
6. Press the **Intruders** softkey to edit the intruder information. Select Mode S Extended in the **Intruder Mode** combobox or softkey to display the [Static Mode S Extended Menu](#).
7. Use the controls on [Static Mode S Extended Menu](#) to enter the information for your Mode S Extended intruder.

Static Mode S Extended Minimum Parameters		
Parameter	Default	Selection (Range)
Tx Channel	Gen A	Gen A, Gen C, or Gen D
Altitude	1000	-1000 to 126700 feet
Bearing	0	0 to 359 degrees
Range	0	0 to 160 Nmi
Latitude		-90 to 90 degrees
Longitude		-180 to 180 degrees
Velocity	0	0 to 2000 knots
Vertical Speed	0	+/- 32576 ft/min
Track	0	-180 to 180 degrees
Reply Power	-20	-20 to -90 dBm (Low Power) 1 to -69 dBm (Hi Power)
Reply Antenna	By Altitude	Bottom, Top, Both, Alternating, By Altitude
Squitter Power	-50	-20 to -90 dBm (Low Power) 1 to -69 dBm (Hi Power)
Squitter Antenna	Both	Top, Bottom, Both
Start at	0	0 to Scenario Duration
Stop at	Scenario Duration	0 to Scenario Duration
Enable	Enable	Enable/Disable
Reply	On	On/Off
Squitter	On	On/Off
Ground	Off	On/Off
DO-260 Mode	DO-260	DO-260, DO-260A, DO-260B
Crosslink Capability	Off	On/Off
Mode S Address		0 – FFFFFFFF
Override Range Calculation	Off	On/Off
Altitude Code Mode	Binary	Binary, Gilham
Reply Probability	1	0, 0.2, 0.4, 0.6, 0.8, 1
Squitter Probability	1	0, 0.2, 0.4, 0.6, 0.8, 1
Mode A Code	0000	0000-7777 (Octal)

Identification Code	Static (STAx) xxx = intruder number	Up to 8 characters
Identification Type	1	1-4
Velocity Type	GroundSpeed Normal (1)	0-7
CA	0	0-7
FS	0	0-7
DR	0	0-31
UM	0	0-63
SL	No TCAS Sensitivity Level	0-7
RI (AQ=0)	No on board TCAS	0-7
RI(AQ=1)	No Airspeed	0-7
RI(DF=16)	No on board TCAS	0-15

Note: That for all intruders the location can be entered using range and bearing or latitude and longitude. If range and bearing is used the TTG-7000 will calculate the latitude and longitude of the intruder. If latitude and longitude is being used the TTG-7000 will calculate the range and bearing from the own aircraft.

8. When all the required information is entered press the **Back** softkey on the bottom of the softkey area to return to the [TCAS Scenario Menu](#).
9. To start the scenario use the **Scenario** softkey. Once the scenario has started the **Run Time** box on the top of the menu should be changing with the current scenario time.
10. If the scenario terminates, the **Scenario** softkey will return to the off position. If user wants to terminate the scenario before the total scenario time, change the **Scenario** softkey to the off position.

3.2.12. How to Setup a Dynamic Mode S Extended Intruder

1. Go to the TTG-7000 [Main Menu](#).
2. Press the **TCAS** softkey to display [TCAS Main Menu](#).
3. Press the **Scenario** softkey to display the [TCAS Scenario Menu](#).
4. Use the **Scenario Time** combobox or softkey to enter the scenario time.
5. Set the number of dynamic intruders to at least 1 using either the **Number of Dynamic Intruders** combobox or softkey.
6. Press the **Intruders** softkey to edit the intruder information. Select Mode S Extended the **Intruder Mode** combobox or softkey to display the [Dynamic Mode S Extended Menu](#).
7. Use the controls on [Dynamic Mode S Extended Menu](#) to enter the information for your Mode S Extended intruder.

Dynamic Mode S Extended Minimum Parameters		
Parameter	Default	Selection (Range)
Tx Channel	Gen A	Gen A, Gen C, or Gen D
Altitude	1000	-1000 to 126700 feet
Bearing	0	0 to 359 degrees
Range	0	0 to 160 Nmi
Latitude		-90 to 90 degrees
Longitude		-180 to 180 degrees
Velocity	0	0 to 2000 knots
Vertical Speed	0	+/- 32576 ft/min
Track	0	-180 to 180 degrees
Reply Power	-20	-20 to -90 dBm (Low Power) 1 to -69 dBm (Hi Power)
Reply Antenna	By Altitude	Bottom, Top, Both, Alternating, By Altitude
Squitter Power	-50	-20 to -90 dBm (Low Power) 1 to -69 dBm (Hi Power)
Squitter Antenna	Both	Top, Bottom, Both
Start at	0	0 to Scenario Duration
Stop at	Scenario Duration	0 to Scenario Duration
Enable	Enable	Enable/Disable
Reply	On	On/Off
Squitter	On	On/Off
Ground	Off	On/Off
Crosslink Capability	Off	On/Off
Mode S Address		0 – FFFFFFF
Altitude Code Mode	Binary	Binary, Gilham
Reply Probability	1	0, 0.2, 0.4, 0.6, 0.8, 1
Squitter Probability	1	0, 0.2, 0.4, 0.6, 0.8, 1
Mode A Code	0000	0000-7777 (Octal)
CA	0	0-7
FS	0	0-7
DR	0	0-31
UM	0	0-63
SL	No TCAS Sensitivity Level	0-7
RI (AQ=0)	No on board TCAS	0-7
RI(AQ=1)	No Airspeed	0-7

Note: That for all intruders the location can be entered using range and bearing or latitude and longitude. If range and bearing is used the TTG-7000 will calculate the latitude and longitude of the intruder. If latitude and longitude is being used the TTG-7000 will calculate the range and bearing from the own aircraft.

8. When all the required information is entered press the **Back** softkey on the bottom of the softkey area to return to the [TCAS Scenario Menu](#).
9. To start the scenario use the **Scenario** softkey. Once the scenario has started the **Run Time** box on the top of the menu should be changing with the current scenario time.
10. If the scenario terminates, the **Scenario** softkey will return to the off position. If user wants to terminate the scenario before the total scenario time, change the **Scenario** softkey to the off position.

4. REMOTE CONNECTION (VNC)

Open Internet Browser (Internet Explorer, Safari), in the address field enter http://IPAddress(TTG7000):5800. Port 5800 is the VNC Viewer port. A VNC viewer will be downloaded into your PC or MAC. A security dialog could be shown similar to Figure 4.1. Select Run.

Once the VNC Viewer is running a screen similar to Figure 4.2 (VNC Viewer Connection Details) will be shown. Select OK.

A screen similar to Figure 4.3 (VNC Authentication) will be illustrated. All TTG7000 are setup with the password atg by default at the factory. Enter atg and press return. If the operator has changed the password of their TTG7000, then enter the new password.

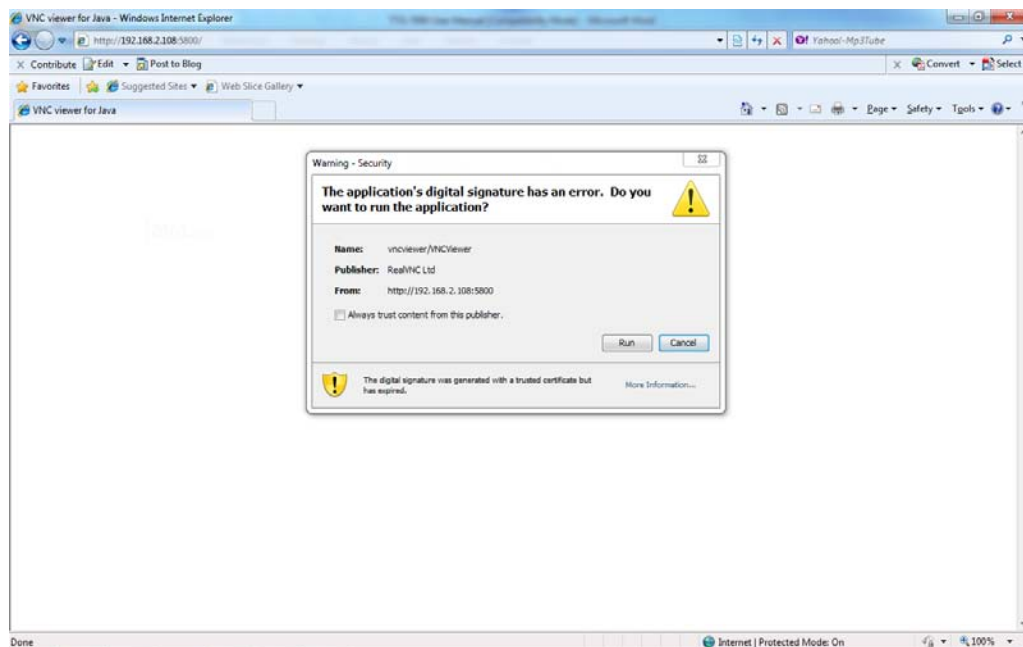

Figure 4.1 – VNC Viewer Download

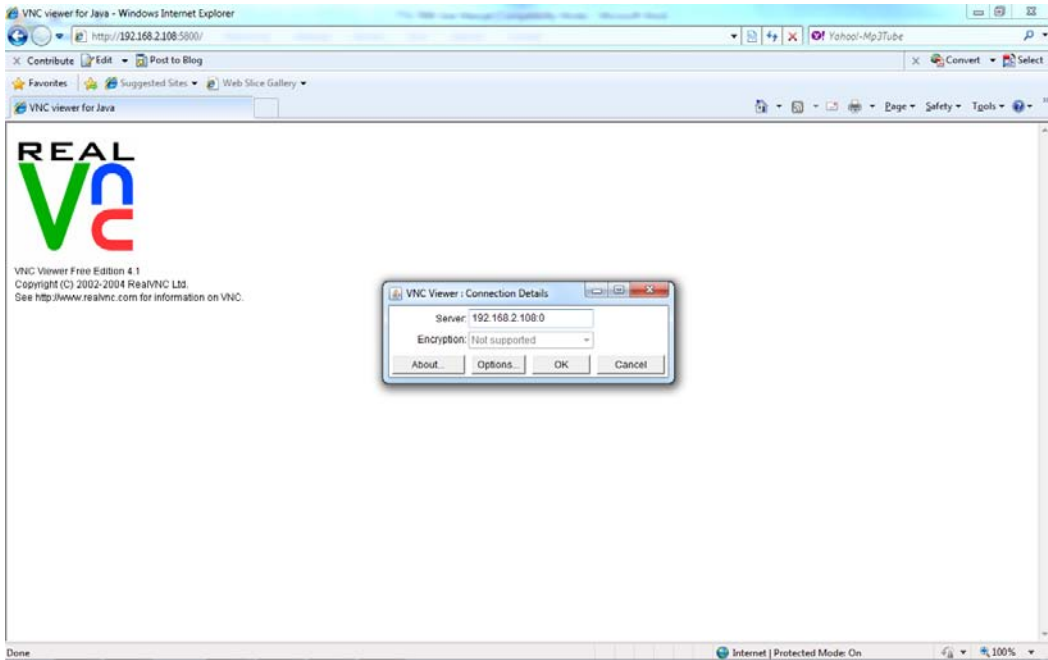

Figure 4.2 – VNC Viewer Connection Details

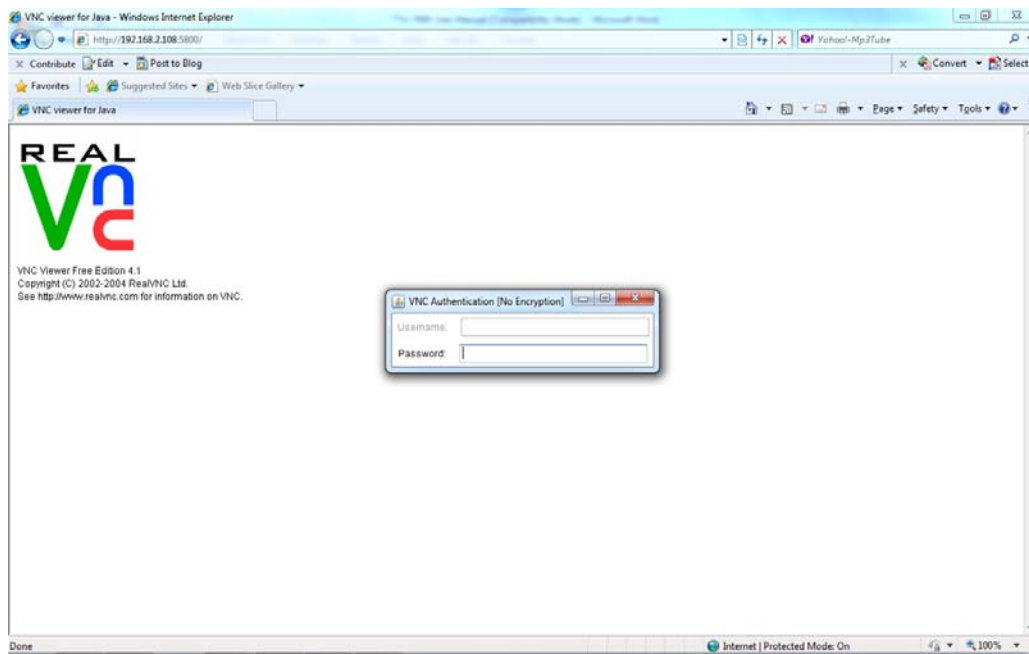

Figure 4.3 – VNC Authentication

Once the password has been authenticated, a VNC Viewer form (Figure 4.4) will be displayed with the current screen on the TTG7000. Use the PC's mouse and keyboard to navigate between screens and modify parameters on the TTG7000. To stop using the VNC Viewer just close the VNC Viewer form.

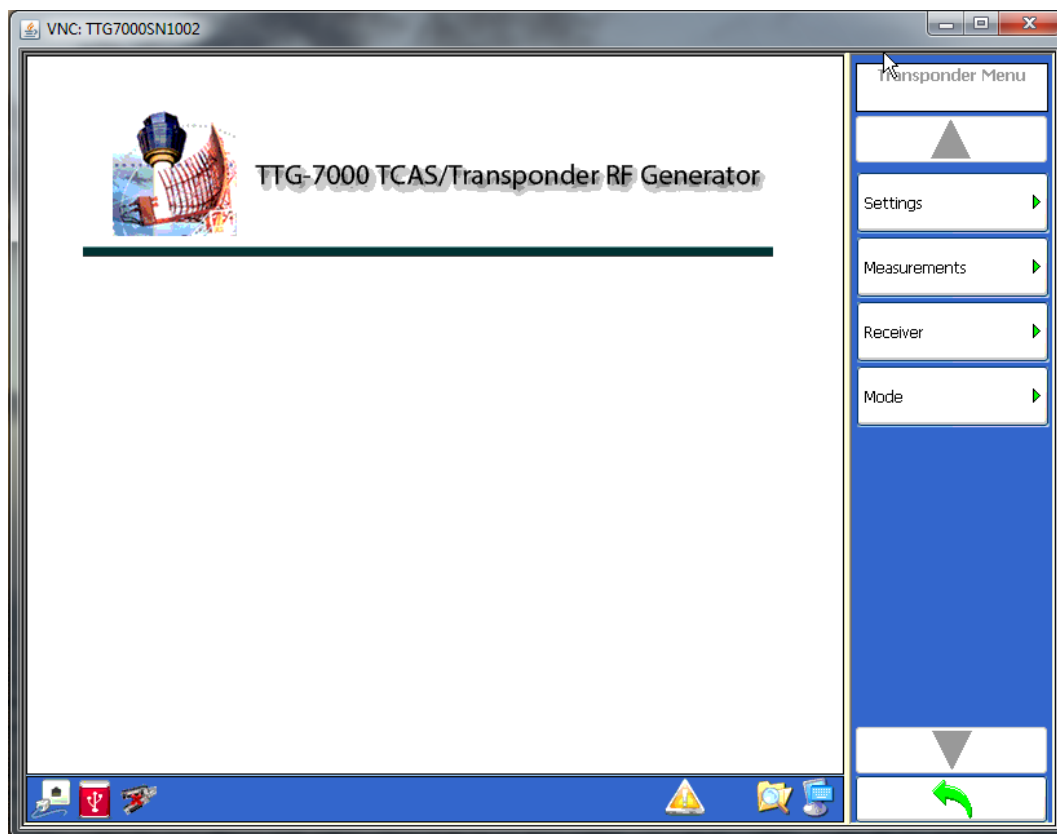
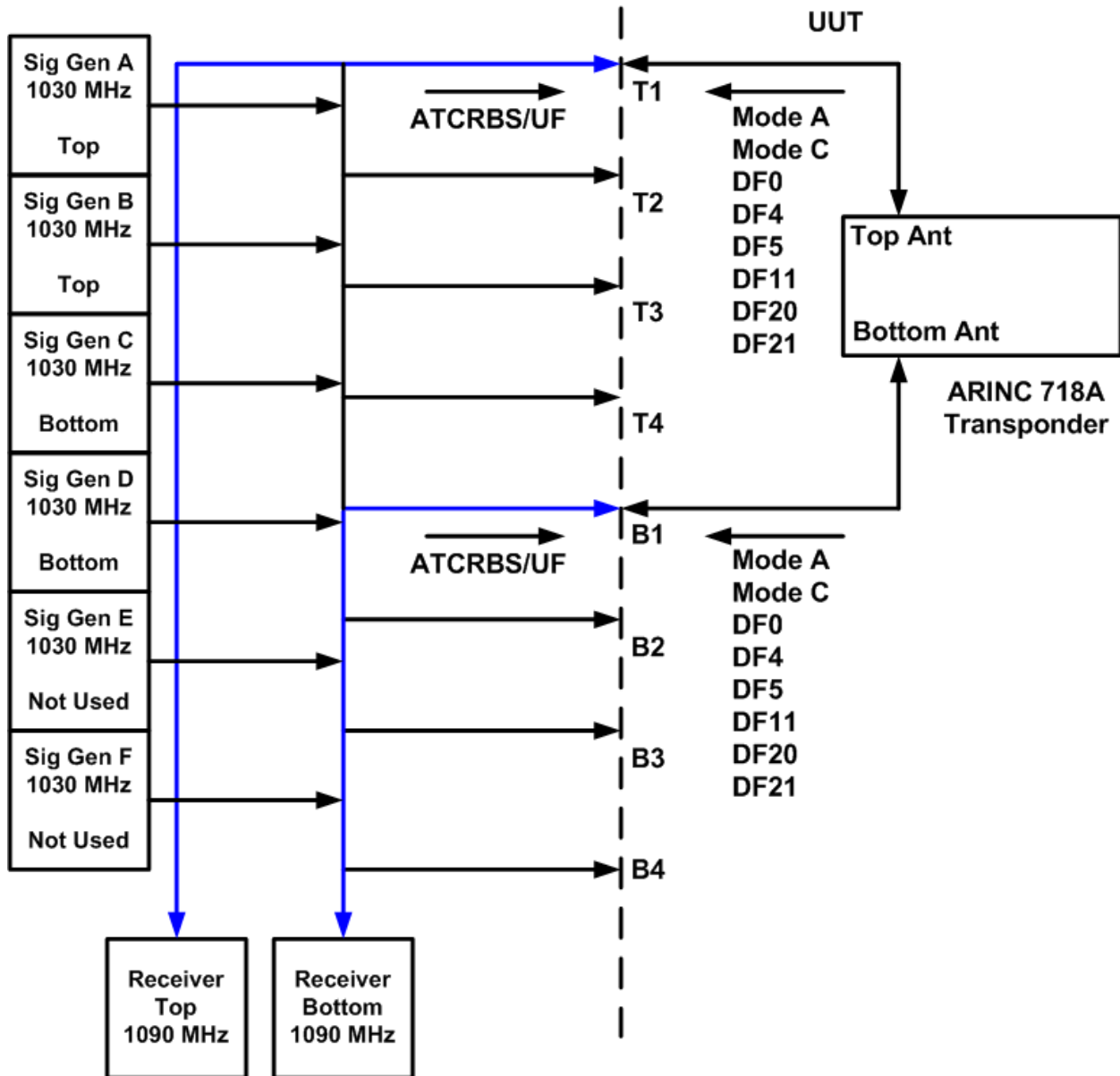

Figure 4.4 – TTG7000 TouchScreen Software on VNC Viewer

To establish a VNC remote connection from an IPAD or Smartphone, download a VNC app into the device. Enter the IP Address of the TTG7000. Enter the password and the TTG7000 screen will be displayed on your IPAD or Smartphone.

5. TEST CONFIGURATIONS

Transponder ATC/Mode S/ELS/EHS Test Configuration



Transponder ADS-B Out (1090ES) Test Configuration

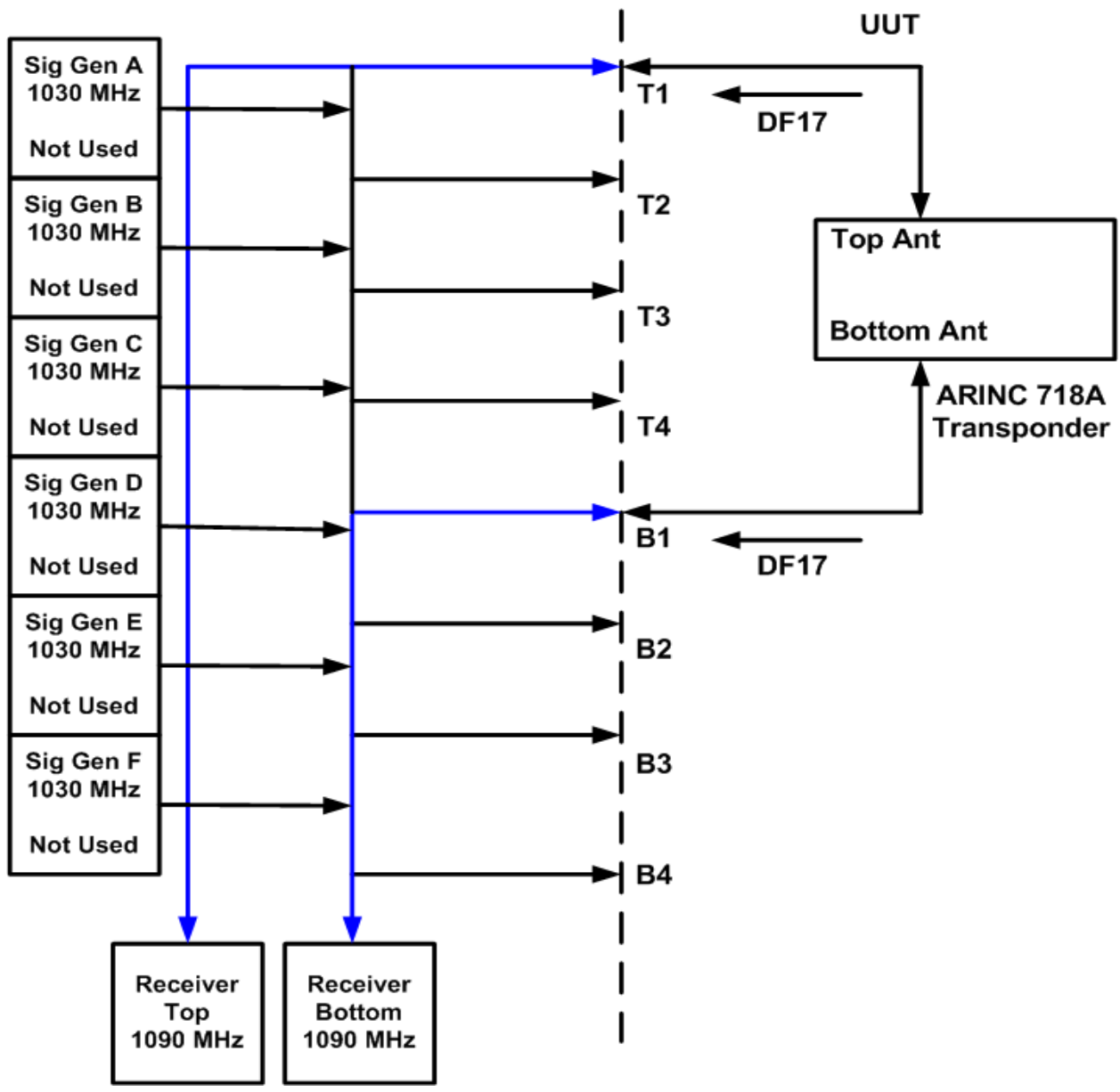

TCAS/Hybrid Surveillance/ITP Version 0/1 Validation Test Configuration

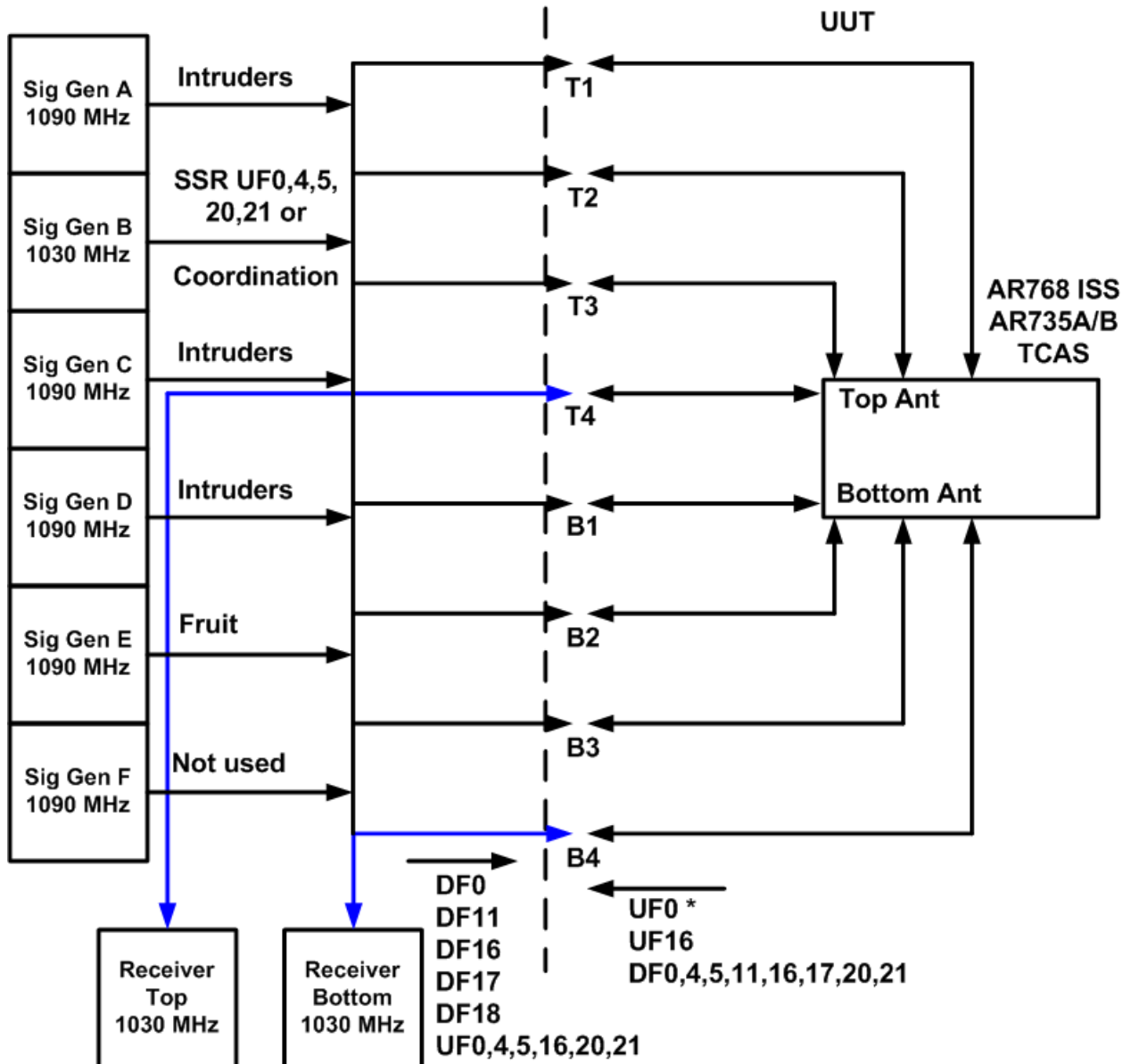

TTG-7000 allows connecting a TCAS antenna to bottom/top antenna port and simulating targets on opposite port.

ADS-B In /CDTI Test Configuration

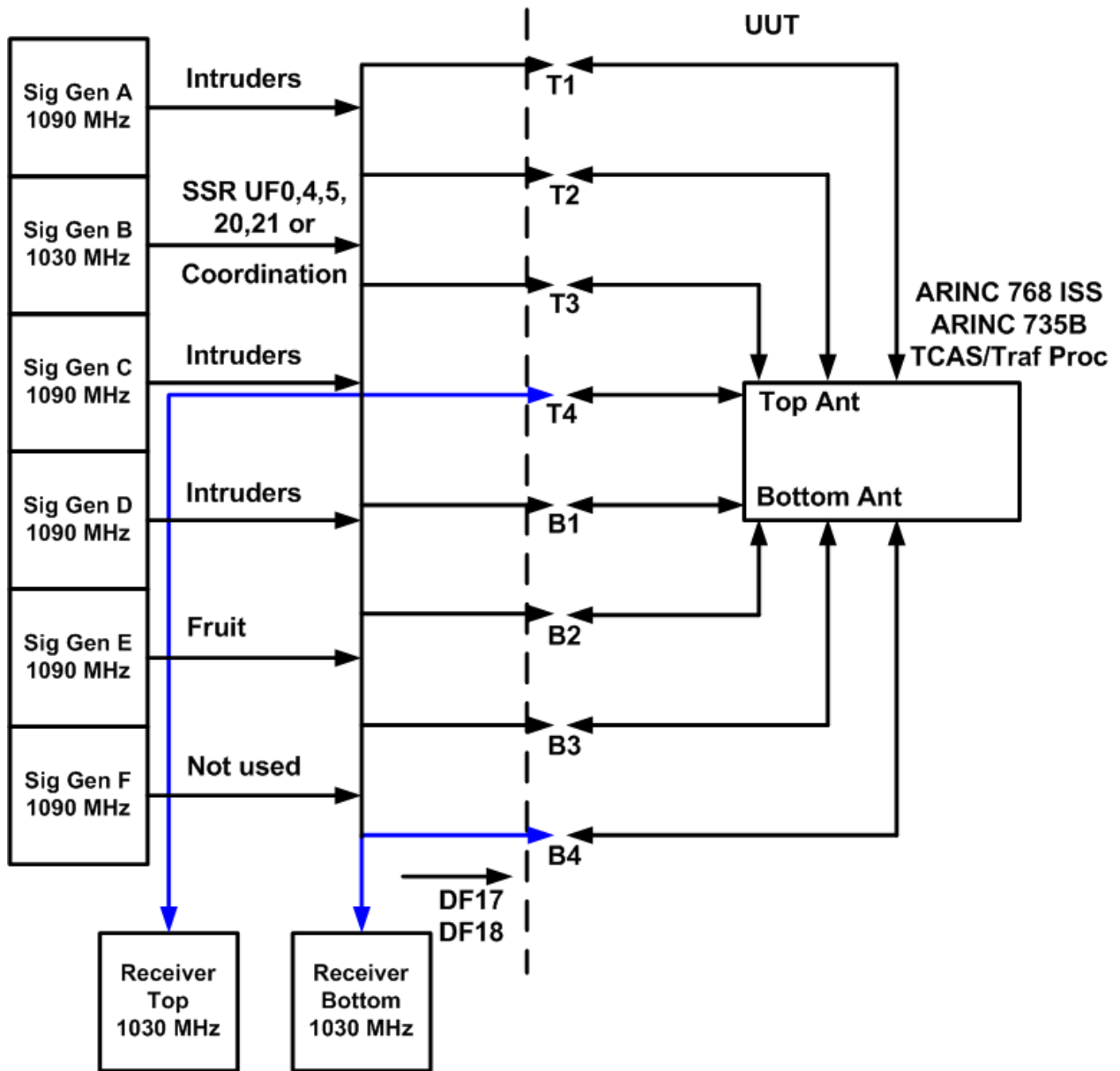

TCAS Coordinated RA Test Configuration

